

---

# Industrial pressure and vacuum switches

XMLA, XMLB, XMLC, XMLD, 9012G and 9016G

## Catalog



Simply easy!™



---

*Selection guide* ..... pages 2 and 3  
*Selecting a pressure switch* ..... pages 4 and 5  
*Terminology* ..... pages 6 and 7

## XML electromechanical pressure and vacuum switches

- Introduction ..... pages 8 to 18
- Selection and specifications ..... pages 19 to 56
- Accessories ..... page 57
- Dimensions ..... pages 58 to 61
- Materials in contact with fluid ..... pages 62 and 63

## 9012G pressure switches

- Introduction ..... pages 64 to 66
- Technical overview ..... pages 66 to 69
- Renewal parts ..... page 75
- Selection and specifications ..... pages 70 to 77
- Modifications ..... page 77
- Dimensions ..... pages 80 to 82

## 9016G vacuum switches

- Selection and specifications ..... pages 78 and 79
- Modifications ..... pages 79 and 83
- Dimensions ..... page 83

Product reference index ..... pages 84 and 85



# Electromechanical pressure and vacuum switches

## XML range

Applications	Type of installation	Control circuits		
	Media controlled	Air, water, hydraulic oils, corrosive fluids, viscous products		
	Type of operation	Fixed differential: detection of a single threshold	Adjustable differential: regulation between two thresholds	Dual-stage switches: fixed differential, detection at each threshold



Fluid characteristics	Air, fresh water, sea water, corrosive fluids, viscous products, up to 320 °F (160 °C) depending on model		
Size (pressure range)	-1 to 500 bar (-14.5 to 7250 psi)		
Type of contacts	1 C/O single-pole, snap action	2 C/O single-pole, simultaneous, snap action	2 C/O single-pole, staggered, snap action
Degree of protection	IP66 with terminal connections IP65 with plug-in connector	IP66 with terminal connections	IP66 with terminal connections IP65 with plug-in connector
Agency listings	CCC, BV, cULus		
Electrical connection	Screw terminals: 1 tapped entry: 1/2 NPT; M20 x 1.5 mm for ISO conduit/cable; or PG 13.5 conduit/cable entry. Connector: DIN 43650, M12		
Pressure connection	G 1/4 (BSP female), 1/4" NPTF, PT 1/4 (JIS B0203)		
Type reference	<b>XMLA</b>	<b>XMLB</b>	<b>XMLC</b>
Pages	19 to 56		

**Note:** For electromechanical pressure and vacuum switches with alternative tapped cable or fluid entries, consult our Customer Care Center.

# Industrial pressure and vacuum switches

## 9012G and 9016G ranges

Applications	Type of installation	Control circuits				Power circuits
	Media controlled	Air, water, hydraulic oils (1), gases and steam				
	Type of operation	Fixed differential: detection of a single threshold	Adjustable differential: regulation between two thresholds	Differential-pressure (change in the difference between two pressures)	Dual-stage switches: Fixed differential, detection at each threshold	Vacuum switches for control circuits



Fluid characteristics	Up to 248 °F (120 °C)				
Size (pressure range)	Diaphragm: 0.2–675 psi on falling pressure Piston actuated: 20–9,000 psi on falling pressure		0–28.7 inHg	0–25 inHg	
Type of contacts	SPDT or DPDT double break contacts; SPDT single break contacts			DPST (SPDT for Form H)	
Degree of protection	NEMA 1, 4, 4X, 13, 7 or 9, depending on model				
Agency listings	UL Listed and CSA certified as industrial control equipment				
Electrical connection (enclosed devices)	1/2"-14 NPTF, PG13.5, or ISO M20; 3/4"-14 NPTF available only on NEMA 7 and 9. NEMA 1 is 1/2" conduit entry, unthreaded.		1/2"-14 NPT	3 x 1/2" conduit entry, unthreaded	
Pressure connection	G1/4 (BSP) female, 1/4"-18 NPTF, 1/4-18 NPT internal or external (depending on model), 1/2"-14 NPT				
Type reference	9012GD, 9012GE, 9012GF, 9012GR, 9012GT	9012GA, 9012GB, 9012GC, 9012GN, 9012GP, 9012GQ	9012GGW, 9012GHW	9012GKW, 9012GMW	9016GAW 9016GVG
Pages	70 to 79				

(1) The hydraulic fluids used for laboratory testing are equivalent to SAE 30 W oils. If oils have less viscosity than this type of oil, leakage can be expected. Telemecanique Sensors does not have test data to support or predict fluid bypass with oils less than SAE 30W.

## Steps for selecting a pressure switch



The deciding factors in the selection of a pressure switch for use on control circuits(1) depend on the requirements of the application. Consider the following requirements to help determine the appropriate commercial reference for your application.

**1. Setpoints:** Do you want to control/monitor one setpoint or two?

- One setpoint: fixed differential
- Two setpoints: adjustable differential

Fixed differential

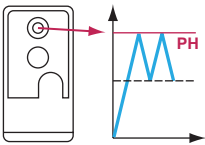

**2. Fluids:** What fluids do you want to control?

- Hydraulic oil, air, fresh water ≤ 70 °C (158 °F)
- Steam
- Hydraulic oil, air, fresh water ≤ 160 °C (320 °F)
- Corrosive fluid ≤ 160 °C (320 °F)
- Sea water ≤ 70 °C (158 °F)
- Viscous fluid ≤ 160 °C (320 °F)
- Sea water ≤ 160 °C (320 °F)

Adjustable differential

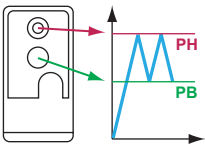

Ensure that the wetted parts of the switch are compatible with the system fluid.

**3. Pressure range:** What pressure range does the system experience?

Note: Select pressure settings that fall within the middle 80% of the pressure range. The pressure applied during a normal cycle should never exceed the maximum range value listed for the switch. Pressure surges should be less than the maximum allowable pressure listed for the switch.

Rated pressure			
XML		9012G / 9016 G (a)	
psi	bar	psi	bar
-14.5 to -4.06	-1 to -0.28	0 to 28 inHg	
-14.5 to -2.03	-1 to -0.14	0 to 25 inHg	
-2.9 to -0.029	-0.2 to -0.02	5 to 25 inHg (9016GVG only)	
-7.25 to 72.5	-0.5 to 5	0.2 to 10	0.01 to 0.69
0 to 0.725	0 to 0.05	1 to 40	0.07 to 2.76
0 to 5.075	0 to 0.35	1.5 to 75	0.10 to 5.17
0 to 14.5	0 to 1	3 to 150	0.21 to 10.34
0 to 36.25	0 to 2.5	5 to 250	0.34 to 17.24
0 to 58	0 to 4	13 to 425	0.90 to 29.30
0 to 145	0 to 10	20 to 675	1.38 to 46.54
0 to 290	0 to 20	20 to 1000	1.38 to 68.95
0 to 507.5	0 to 35	90 to 2900	6.21 to 199.95
0 to 580	0 to 40	170 to 5600	11.72 to 386.11
0 to 1015	0 to 70	270 to 9000	18.62 to 620.53
0 to 2320	0 to 160	0 to 75 (b)	0 to 5.17 (b)
0 to 4350	0 to 300	0 to 175 (b)	0 to 12.07 (b)
0 to 7250	0 to 500	0 to 500 (b)	0 to 34.47 (b)
		0 to 5000 (b)	0 to 344.74 (b)

(a) For 9016G vacuum switches, the unit of rated pressure is inHg.

(b) Pressure switches for differential-pressure operation.

**4. Surges:** How frequent are surges in your system, and what is their maximum pressure level? Applications experiencing frequent or high-pressure surges may require a device with a higher pressure range.

**5. Differential:** The required differential may exclude some pressure range choices.

(1) For switches used on power circuits, see catalog 9013CT9701, *Commercial Pressure Switches, Class 9013 Types F and G.*

6. **Enclosure:** What type of enclosure do you need?
- Open style
  - NEMA Type 1
  - NEMA Type 7, 9
  - NEMA Type 4, 4X, 13 / IP66, IP65
7. **Output:** What output type do you require?
- SPDT contacts, 1 N/O, 1 N/C
  - 2 SPDT contacts, 1 N/O, 1 N/C
  - Dual stage, 1 SPDT contact each stage, 1 N/O, 1 N/C
  - Horsepower rated, 9016GVG vacuum switch only
8. **Electrical connection:** What type of electrical connection do you require?
- 1/2"- 14 NPTF
  - ISO M20 metric threads
  - Type 13 (PG 13.5) metric threads
  - 3/4"-14 NPTF (available only on NEMA 7 & 9)
  - No threaded connection (open style or NEMA 1 only)
9. **Pressure connection:** What type of pressure connection do you require?
- 1/4"- 18 NPTF (female)
  - 1/2" - 14 NPT
  - G 1/4 BSP (female) metric thread
  - PT 1/4 (JIS B0203)
  - 7/16"-20 UNF-2B

10. **Special features:** Do you require any special features?

See the modification table on page 83 for available modifications for 9012 and 9016G pressure switches. (Form designations are added to the end of the part number of the standard device for these products.) Some examples are:

- Pilot light
- Prewired receptacles
- External range adjustment
- Range scale window
- Special factory pressure settings
- Pressure connections

When switches must be factory set and only one setting is identified, specify whether this setting is on rising or falling pressure. See "Special factory setting specified (If indicating only one special setting, specify whether this setting is on increasing or decreasing pressure.)" in the modification table on page 83.

11. **System response time**

- If system response time is critical, select a switch with a volumetric displacement that is compatible with the overall system. See the table below .

Volumetric displacement of 9012G pressure switches		
Class 9012 Type	Volumetric displacement (1) (in <sup>3</sup> )	Volumetric displacement (1) (cm <sup>3</sup> )
GAR, GAW, GDR, GDW-1& 21	0.20774	3.40422
GAR, GAW, GDR, GDW-2 & 22	0.07040	1.15385
GAR, GAW, GDR, GDW-4 & 24	0.04320	0.70805
GAR, GAW, GDR, GDW-5 & 25	0.02144	0.35140
GAR, GAW, GDR, GDW-6 & 26	0.01376	0.22553
GBR, GBW, GER, GEW-1 & 21	0.00200	0.13112
GBR, GBW, GER, GEW-2 & 22	0.00512	0.08392
GCR, GCW, GFR, GFW-1 & 21	0.00320	0.05245
GCR, GCW, GFR, GFW-2 & 22	0.00117	0.01922
GCR, GCW, GFR, GFW-3 & 23	0.00060	0.00924
GCR, GCW, GFR, GFW-4 & 24	0.00037	0.00612

(1) Figures shown are total displacement. When the switch is operated between settings only, displacement is 1/3 of the values shown.

## Terminology

### Measuring range

The measuring range (MR) of a pressure sensor corresponds to the difference between the upper and lower values measured by the load cell. It ranges between 0 and the pressure corresponding to the size of the sensor.

### Operating range

The **operating range of a pressure transmitter** corresponds to its measuring range. Within this range, its analog output signal varies between 4 and 20 mA or 0 and 10 V, and is proportional to the measured pressure.

The **operating range of a pressure or vacuum switch** is the difference between the values of the minimum low setpoint (PB) and the maximum high setpoint (PH).

### Precision

This includes linearity, hysteresis, repeat accuracy, and setting tolerances. It is expressed as a percentage of the measuring range of the load cell (%MR).

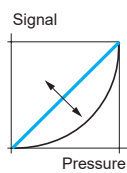

The **linearity** is the maximum deviation between the real transmitted curve and the ideal curve.

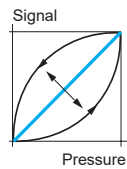

The **hysteresis** is the maximum deviation between the rising pressure curve and the falling pressure curve.

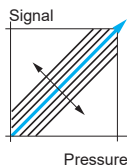

The **repeat accuracy** is the maximum drift encountered at varying pressures under given conditions.

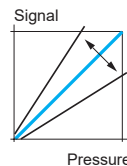
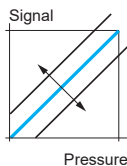

The **setting tolerances** are the manufacturer's tolerances with regard to the zero point and sensitivity (gradient of output signal curve from pressure transmitter).

### Temperature drift

The precision of a pressure sensor is susceptible to variation due to the operating temperature.

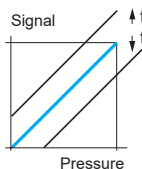

**Zero point drift**, proportional to the temperature, is expressed as %MR/°C.

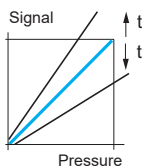

**Sensitivity drift**, proportional to the temperature, is expressed as %MR/°C.



## Terminology (continued)

### Switching point on rising pressure (PH)

This is the upper pressure setting at which the output of the electronic pressure or vacuum switch changes state on rising pressure.

### Switching point on falling pressure (PB)

This is the lower pressure setting at which the output of the electronic pressure or vacuum switch changes state on falling pressure.

### Differential

This is the difference between the switching point on rising pressure (PH) and the switching point on falling pressure (PB). The low point can be set at the values indicated on the operating curves shown on the product pages.

### Switches with fixed differential

Depending on the switch, either the high or low operating point is adjustable, and the other operating point follows. The window is fixed.

### Switches with adjustable differential

An adjustable differential allows independent setting of both operating points.

### Spread

For dual-stage switches, the spread indicates the difference between the two operating points on rising pressure (PH2 and PH1) and, for vacuum switches, the difference between the two operating points on falling pressure (PB2 and PB1).

### Differential-pressure sensing

Switches for differential-pressure sensing measure the difference between two pressures.

### Size

#### Pressure transmitters and pressure switches

This is the maximum value of the operating range.

#### Vacuum transmitters and vacuum switches

This is the minimum value of the operating range.

### Accuracy (switches with setting scale)

The tolerance between the point at which the switch actuates its contacts and the value indicated on the setting scale. Where very high setting accuracy is required (initial installation of the product), it is recommended that you use separate measuring equipment (pressure gauge, etc.).

### Repeat accuracy

This is the variation in the operating point between several successive operations, or the tolerance between two consecutive switching operations.

### Drift (F)

The tolerance of the operating point throughout the entire service life of the switch.

### Maximum allowable pressure

The maximum value of an accidental pressure surge of very short duration (a few milliseconds).

### Maximum permissible accidental pressure

This is the maximum pressure (excluding pressure surges) that the sensor can occasionally withstand without permanent damage.

### Maximum allowable pressure per cycle (Ps)

The maximum pressure level per cycle that the switch can withstand for optimum service life.

### Surge

A surge is a high rate of rise in pressure, normally of short duration, caused by starting a pump or by opening and closing a valve. Depending on frequency and duration, surge can reduce service life. Extremely high rates of rise in pressure can be damaging even if they are within the limits of the maximum allowable pressure.

### Destruction pressure

Also called *burst pressure*, the destruction pressure is the pressure value which, if exceeded, is likely to cause serious damage to the sensor—such as leaking, bursting, or permanent damage.

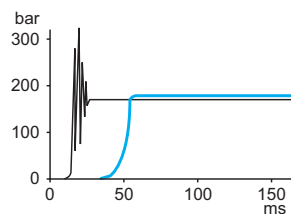
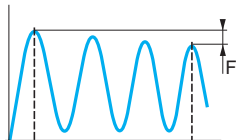
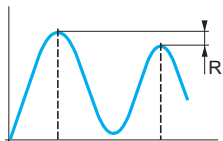
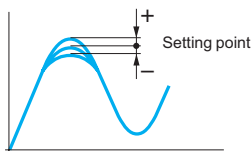

Example 1: With destructive (burst) pressure level

— Without damping device  
— With damping device

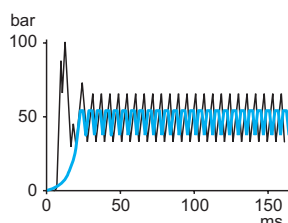

Example 2: With destructive (burst) pressure level and destructive pressure oscillations

# Electromechanical pressure and vacuum switches

## XML range

### Introduction

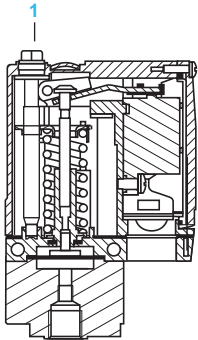

XMLA

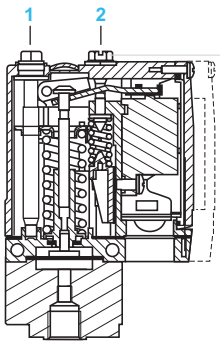

XMLB, XMLC

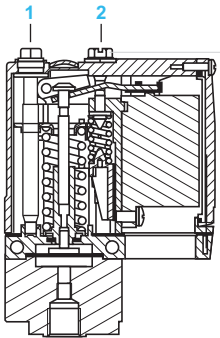

XMLD

XML pressure and vacuum switches for control circuits are used to control the pressure of hydraulic oils, fresh water, sea water, air, steam, corrosive fluids, or viscous products, up to 7250 psi (500 bar).

- **XMLA** pressure and vacuum switches have a fixed differential and are for detection of a single threshold. They incorporate a 1 C/O single-pole contact.
- **XMLB** pressure and vacuum switches have an adjustable differential and are for regulation between two thresholds. They incorporate a 1 C/O single-pole contact.
- **XMLC** pressure and vacuum switches have an adjustable differential and are for regulation between two thresholds. They incorporate two C/O single-pole contacts.
- **XMLD** pressure and vacuum switches are dual-stage switches, each stage with a fixed differential, and are for detection at each threshold. They incorporate two C/O single-pole contacts (one per stage).

### Setting

#### XMLA: pressure and vacuum switches with fixed differential

- **Rising pressure**—Operating point PH is set by adjusting the red screw **1**.
- **Falling pressure**—Operating point PB is not adjustable.

The difference between the trip and reset points of the contact is the inherent differential of the switch (contact differential, friction, etc.).

#### XMLB and XMLC: pressure and vacuum switches with adjustable differential

When setting the pressure and vacuum switches, first adjust the operating point on rising pressure (PH), then the operating point on falling pressure (PB).

- **Rising pressure**—Operating point PH is set by adjusting the red screw **1**.
- **Falling pressure**—Operating point PB is set by adjusting the green screw **2**.

#### XMLD: dual-stage pressure and vacuum switches with fixed differential for each threshold

##### Operating point on rising pressure of stage 1 and stage 2

- **First stage** operating point on rising pressure (PH1) is set by adjusting the red screw **1**
- **Second stage** operating point on rising pressure (PH2) is set by adjusting the blue screw **2**.

##### Operating point on falling pressure

The operating points on falling pressure (PB1 and PB2) are not adjustable.

The difference between the trip and reset points of each contact is the inherent differential of the switch (such as contact differential or friction).

# Electromechanical pressure and vacuum switches

## XML range

Specifications	
Environmental specifications	
Conformity to standards	CE, UKCA, IEC/EN/UL/CSA 60947-5-1
Product certifications	CCC, BV, cULus
Ambient air temperature, °F (°C)	For operation: -13 to +158 (-25 to +70). Storage: -40 to +158 (-40 to +70)
Fluids or products controlled	Hydraulic oils, air, fresh water, sea water, 32–320 °F (0 to 160 °C), depending on model Steam, corrosive fluids, viscous products, 32–320 °F (0 to 160 °C), depending on model
Materials	Case: zinc alloy. Component materials in contact with fluid: see page 62.
Operating position	All positions
Vibration resistance	4 gn (30–500 Hz) conforming to IEC 68-2-6 except <b>XMLL35</b> , <b>XML001</b> and <b>XMLBM03</b> : 2 gn
Shock resistance	50 gn conforming to IEC 68-2-27 except <b>XMLL35</b> , <b>XML001</b> and <b>XMLBM03</b> : 30 gn
Electric shock protection	Class I conforming to IEC 1140
Degree of protection	Screw terminal models: IP66 conforming to IEC/EN 60529 Connector models: IP65 conforming to IEC/EN 60529
Operating rate (operating cycles/minute)	Piston version switches: up to 60 cycles/minute for temperatures greater than 32 °F (0 °C) Diaphragm version switches: up to 120 cycles/minute for temperatures greater than 32 °F (0 °C),
Repeat accuracy	< 2%
Pressure connection (1)	<ul style="list-style-type: none"> <li>G 1/4 (BSP female)</li> <li>1/4"-18 NPTF female</li> <li>PT 1/4 (JIS B0203).</li> </ul>
Electrical connection (1) for screw terminal models	<ul style="list-style-type: none"> <li>1/2" NPT electrical connections</li> <li>ISO M20 x 1.5 tapped entry</li> <li>DIN Pg 13.5 (n° 13) tapped entry</li> <li>Connector models, either M12 or DIN 43650 A: please consult our Customer Care Center.</li> </ul>

Contact block specifications	
Rated operational specifications	~ AC-15; B300 (Ue = 240 V, Ie = 1.5 A - Ue = 120 V, Ie = 3 A) --- DC-13; R300 (Ue = 250 V, Ie = 0.1 A)
Rated insulation voltage	Ui = 500 V conforming to IEC/EN Ui = 300 V conforming to UL/CSA
Rated impulse withstand voltage	Uimp = 6 kV
Type of contacts Silver tipped contacts	<b>XMLA</b> and <b>XMLB</b> : 1 C/O single-pole contact (4 terminal), snap action <b>XMLC</b> : 2 C/O single-pole contacts (8 terminal), simultaneous, snap action <b>XMLD</b> : 2 C/O single-pole contacts (8 terminal), staggered, snap action
Short-circuit protection	10 A cartridge fuse type gG (gl)
Connection	Screw clamp terminals. Clamping capacity, min: 1 x 0.2 mm <sup>2</sup> , max: 2 x 2.5 mm <sup>2</sup>

Electrical durability Utilization categories AC-15 and DC-13	<b>XMLA and XMLB</b> AC supply ~ 50/60 Hz ~ Inductive circuit, Ithe = 10 A		<b>XMLC and XMLD</b> AC supply ~ 50/60 Hz ~ Inductive circuit, Ithe = 10 A							
	Operating rate: 3600 operating cycles/hour Load factor: 0.5									
	<b>DC supply ---</b> Power broken in W for 1 million operating cycles		<b>DC supply ---</b> Power broken in W for 5 million operating cycles							
	Voltage	V	24	48	120	Voltage	V	24	48	120
	~ W	W	31	29	26	~ W	W	10	7	4

(1) See page 18, "Interpreting the reference for XML Devices" for more information on specifying the electrical and pressure connections.

# Electromechanical pressure and vacuum switches

## XML range

### Function

Pressure and vacuum switches control or regulate pressure or vacuum levels in hydraulic or pneumatic systems. They transform the pressure change into a digital electrical signal when the preset operating points are reached.

### Switches for control circuits

Switches with control-duty rated electrical contacts, designed for control of contactors, relays, power valves, PLC inputs, etc.

### Switches for power circuits

Switches with power electrical contacts (1, 2, or 3 pole) designed for direct switching of single-phase or three-phase motors (pumps, compressors, etc.).

### Pressure switch operating principle

#### Fixed Differential: Detection of a Single Threshold

Fixed differential switches have a single adjustable setting point (either PH or PB). The differential between the high and low points (PH-PB) depends on the construction of the switch. It is not adjustable.

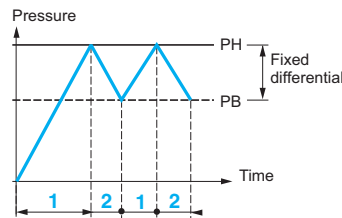

— Adjustable value  
 --- Nonadjustable value

PH = High point (on rising pressure)  
 PB = Low point (on falling pressure)

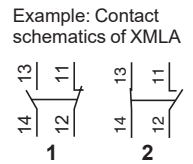

#### Adjustable Differential: Regulation between Two Thresholds

Adjustable differential switches have setting points for both the high point (PH) and the low point (PB). Both of these points can be independently adjusted.

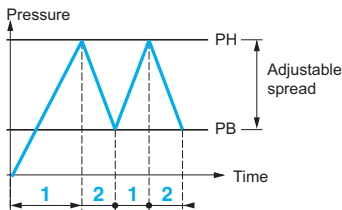

— Adjustable value

PH = High point (on rising pressure)  
 PB = Low point (on falling pressure)

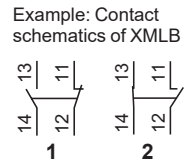

#### Dual-Stage: Detection of Two Thresholds

Dual-stage switches allow two distinct levels of control to be monitored with one device. Each stage allows detection of a single threshold with a single setting point (fixed differential). Both these points can be independently adjusted. However, for both stages, the differential between the high point and the low point (PH1-PB1 and PH2-PB2) is fixed and depends on the construction of the switch.

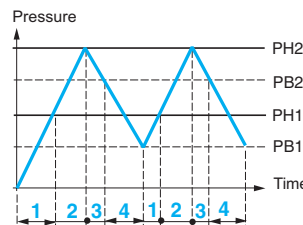

— Adjustable value  
 --- Nonadjustable value

PH = High point (on rising pressure)  
 PB = Low point (on falling pressure)

Example: Contact schematics of XMLD

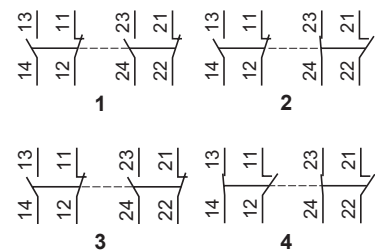

#### Fixed differential

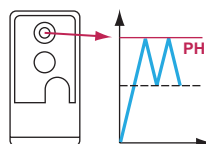

#### Adjustable differential

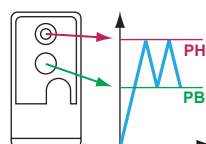

# Electromechanical pressure and vacuum switches

XML range

## Vacuum switch operating principle

### Detection of a single threshold

The switches for detection of a single threshold (fixed differential) have a single adjustable setting point (PH). The differential between the high and low points (PH–PB) depends on the inherent characteristics of the switch. It is not adjustable.

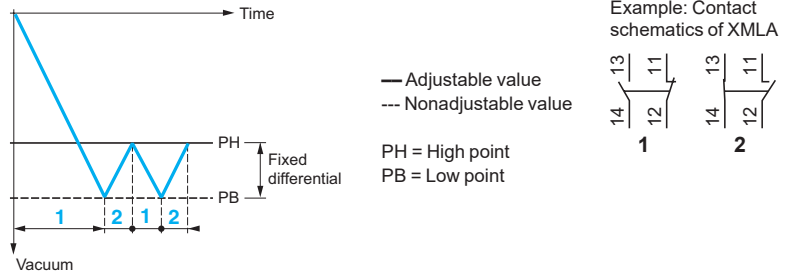

### Regulation between two thresholds

The switches for regulation between two thresholds (adjustable differential) have both a high point setting (PH) and a low point setting (PB). Both of these points can be independently adjusted.

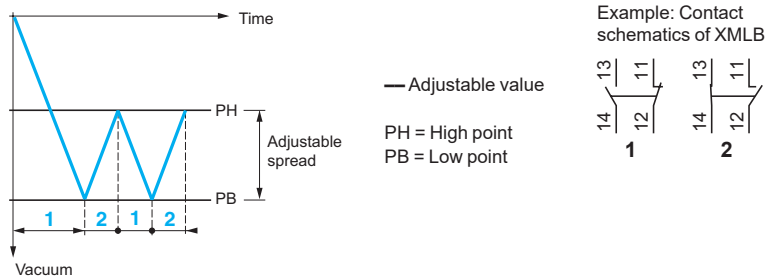

### Detection of two thresholds

The dual-stage switches, for detection at each threshold, have an adjustable high point setting for each stage (PH1 and PH2). Both of these points can be independently adjusted.

For both stages, the differential between the high point and the low point (PH1–PB1 and PH2–PB2) depends on the inherent characteristics of the switch. It is not adjustable.

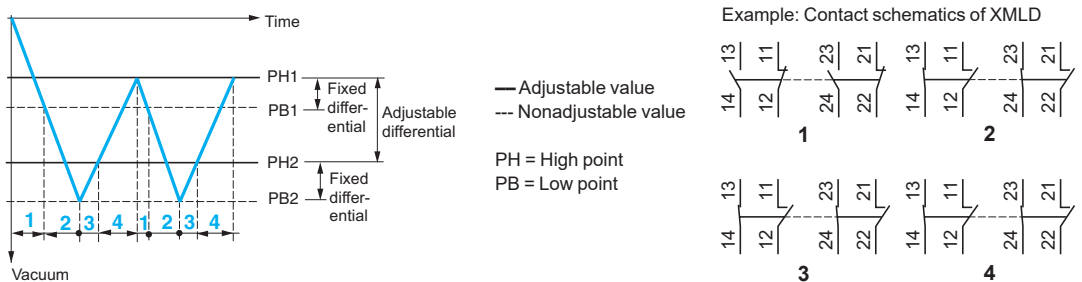

## Maximum allowable accidental pressure

The maximum accidental pressure of XML switches is equal to at least 2.25 times the switch size.

If accidental overpressures occur and their duration is less than 50 milliseconds, the pressure damping device incorporated in the XML switches (sizes 10 bar and greater) reduces the effect.

# Electromechanical pressure and vacuum switches

XML range

## Application range of pressure and vacuum switches types XML, XMA and XMX, for control circuits

**On standard loads:** Continuous duty, frequent switching.

Insulation voltage limit

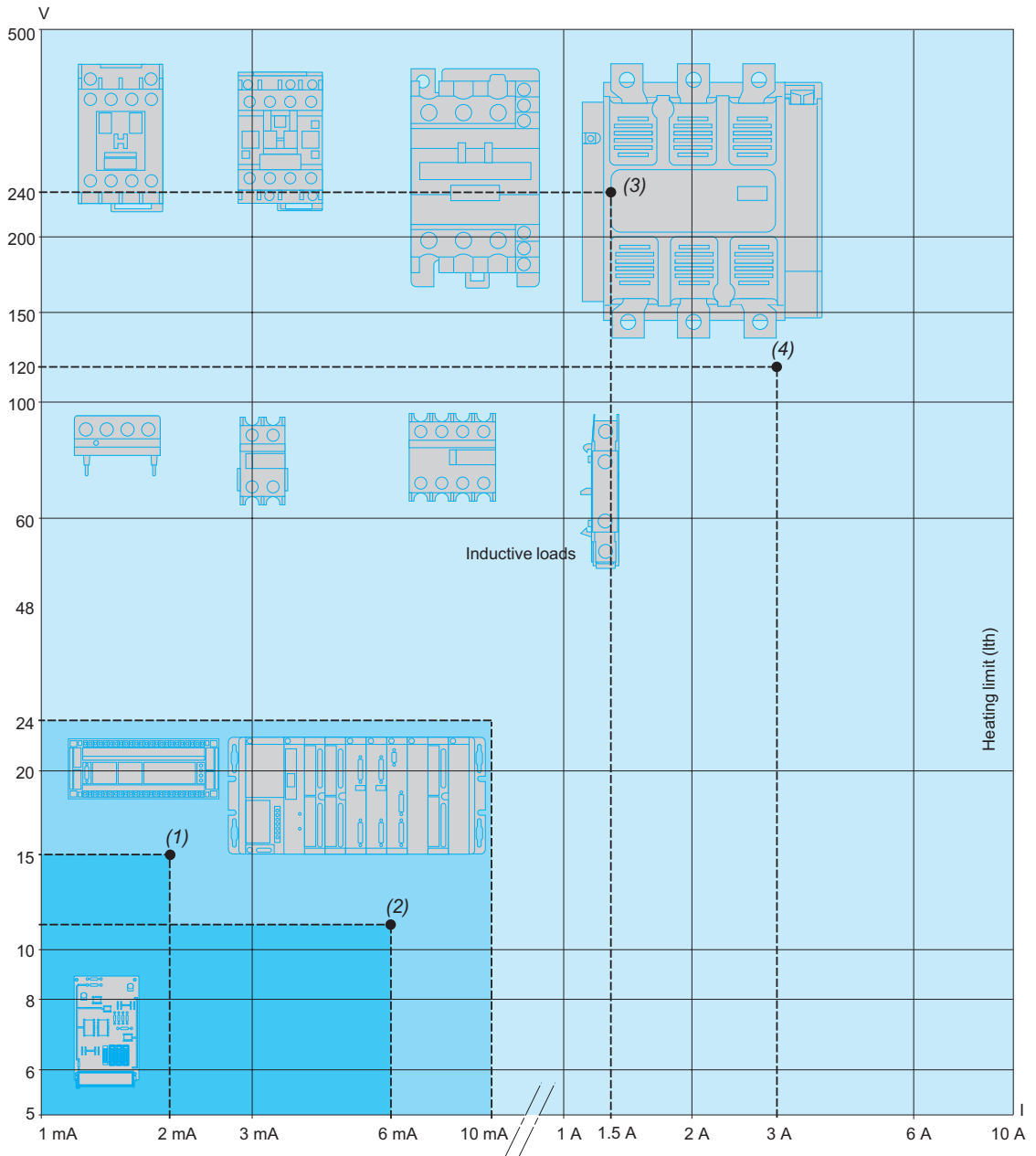

(1) Standard PLC input, type 1

(2) Standard PLC input, type 2

(3) Switching capacity, utilization category AC-15, DC-13

<b>B300</b>	240 V	1.5 A
<b>R300</b>	250 V	0.1 A

(4) Switching capacity, utilization category AC-15, DC-13

<b>B300</b>	120 V	3 A
<b>R300</b>	125 V	0.22 A

PLC: programmable logic controller

**On small loads:** The use of electromechanical pressure and vacuum switches with programmable logic controllers is becoming more prevalent. On small loads, the switches maintain a failure rate of less than 1 for 100 million operating cycles. Results may vary depending on application.

# Electromechanical pressure and vacuum switches

## XML range

### Selecting the switch size

After establishing the type of switch required for the application (single threshold detection or regulation between two thresholds), the selection of its size depends on the following criteria:

- the differential: difference between the high point (PH) and the low point (PB),
- the maximum pressure allowable per cycle,
- repeat accuracy, precision and minimum drift.

### Selecting a fixed differential pressure switch for detecting a single threshold

**Main criterion: minimum differential**

Example: for a selected high point (PH) of 7 bar

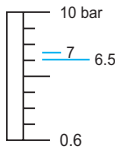

XMLA010...  
Differential = 0.5 bar

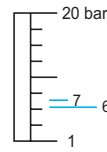

XMLA020...  
Differential = 1 bar

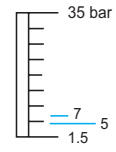

XMLA035...  
Differential = 2 bar

Select an XMLA010... (the lowest size)

**Main criterion: tolerance to overpressures**

Example: for a selected high point (PH) of 12 bar

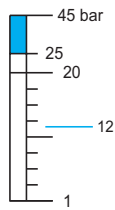

XMLA020...  
Allowable accidental overpressure = 45 bar

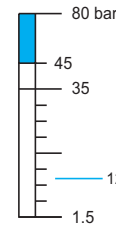

XMLA035...  
Allowable accidental overpressure = 80 bar

Select an XMLA035... (the highest size)

**Main criterion: repeat accuracy, precision and minimum drift**

Example: for a selected high point (PH) of 18 bar

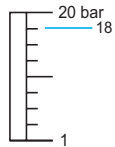

XMLA020...  
Adjustable from 1–20 bar

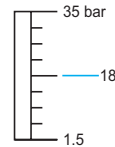

XMLA035...  
Adjustable from 1.5–35 bar

As a general rule, avoid working at the upper or lower limits of the operating range.

Select an XMLA035...

### Converting Units of Pressure

	psi	kg/cm <sup>2</sup>	bar	atm	mm Hg (Torr)	mm H <sub>2</sub> O	Pa
1 psi =	1	0.07031	0.06895	0.06805	51.71	703.7	6895
1 kg/cm <sup>2</sup> =	14.22	1	0.98066	0.96784	735.55	10 000	98 066
1 bar =	14.50	1.0197	1	0.98695	750.06	10 197	10 <sup>5</sup>
1 atm =	14.70	1.0333	1.0132	1	760.0	10 333	101 325
1 mm Hg = (Torr)	0.01934	1.360 x 10 <sup>-3</sup>	1.333 x 10 <sup>-3</sup>	1.316 x 10 <sup>-3</sup>	1	13.59	133.3
1 mm H <sub>2</sub> O =	1.421 x 10 <sup>-3</sup>	10 <sup>-4</sup>	~ 10 <sup>-4</sup>	~ 10 <sup>-4</sup>	0.07361	1	~ 9.80
1 Pa =	1.45 x 10 <sup>-4</sup>	1.0197 x 10 <sup>-5</sup>	10 <sup>-5</sup>	9.8695 x 10 <sup>-6</sup>	7.5 x 10 <sup>-3</sup>	0.10197	1

Example: 1 bar = 14.50 psi = 10<sup>5</sup> Pa

# Electromechanical pressure and vacuum switches

XML range

## Operating curves: Fixed Differential, Detecting a Single Threshold

**Adjustment range of the high point**

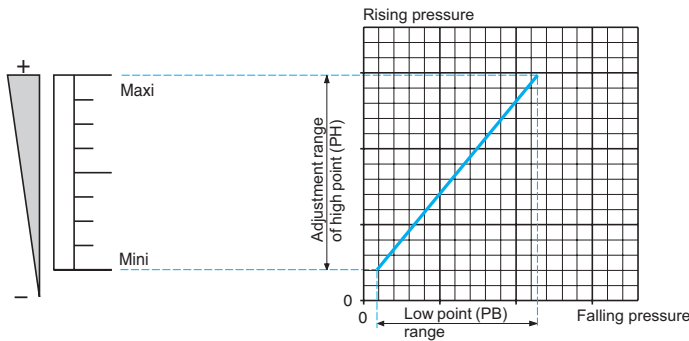

Defined by the difference between the minimum and maximum high point (PH) setting values.

For a high set point (PH), the lower point (PB) is fixed and cannot be adjusted.

For a low set point (PB), the higher point (PH) is fixed and cannot be adjusted.

**Operating point on rising pressure (PH)**

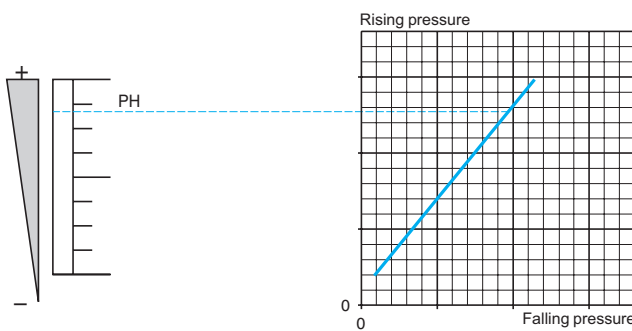

The upper pressure setting at which the pressure or vacuum switch actuates the contacts on rising pressure.

Adjustable throughout the range on rising pressure.

**Operating point on falling pressure (PB)**

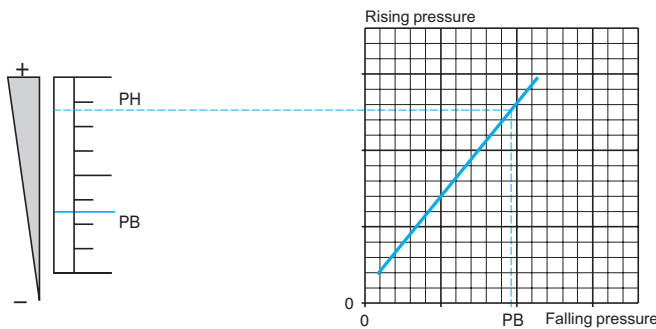

The pressure at which the switch contact changes state on falling pressure.

The lower point (PB) is not adjustable and is entirely dependent on the high point setting (PH) and the inherent differential of the switch.

**Differential**

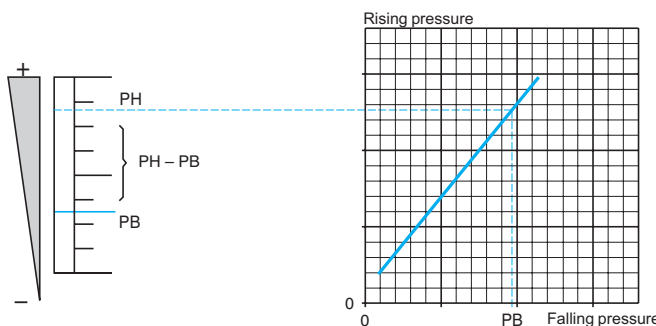

$PH - PB =$  inherent differential

The difference between the operating point on rising pressure (PH) and the operating point on falling pressure (PB).

This point is not adjustable, so the value of the differential is fixed.

It is the inherent differential of the switch (contact differential, friction, etc.).

**Example**

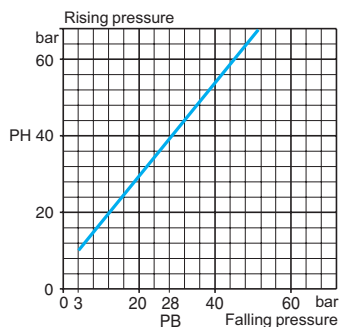

Operating point on rising pressure (PH) is 40 bar (set value at which the contact changes state on rising pressure).

The operating point on falling pressure (PB) is 28 bar (fixed value at which the contact returns to its original state).

Conclusion:  
the differential is  $40 - 28 = 12$  bar.



# Electromechanical pressure and vacuum switches

XML range

## Operating curves: Adjustable Differential, Regulating between Two Thresholds

### Adjustment range of the high point

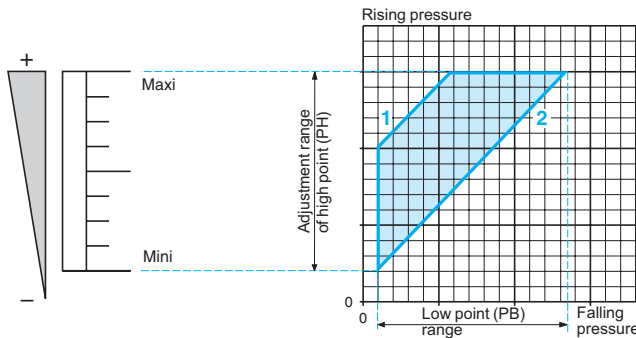

Defined by the difference between the minimum and maximum high point (PH) setting values.

### Operating point on rising pressure (PH)

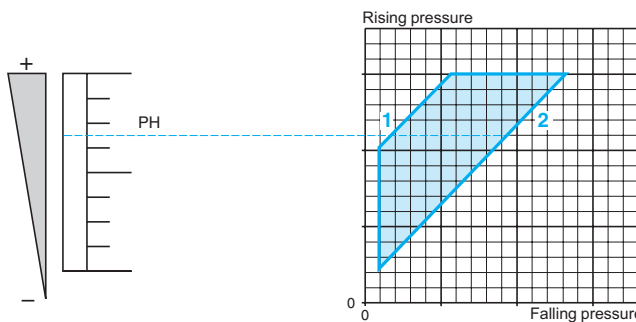

The upper pressure setting at which the pressure or vacuum switch actuates the contacts on rising pressure.  
Adjustable throughout the range on rising pressure.

### Operating point on falling pressure (PB)

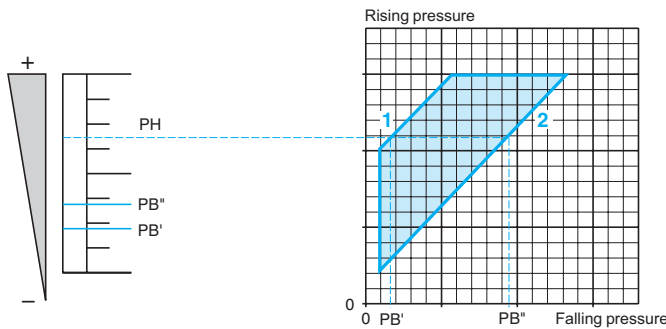

The pressure at which the switch contact changes state on falling pressure.  
The adjustable differential enables the independent setting of the lower point (PB).

### Differential

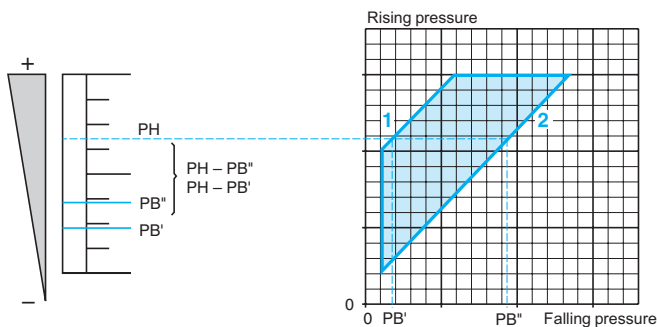

Low point < High point  
 $PH - PB'$  = inherent differential  
 $PH - PB''$  = minimum differential  
 The difference between the operating point on rising pressure (PH) and the operating point on falling pressure (PB).  
**Note:** the low point can be set at any value between  $PB'$  and  $PB''$ .

### Example

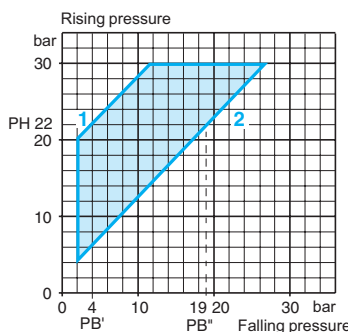

- 1 Maximum differential
- 2 Minimum differential

Operating point on rising pressure (PH) is 22 bar (set value at which the contact changes state on rising pressure).  
 The operating point on falling pressure (PB) ranges from 4 and 19 bar (set value at which the contact returns to its original state).  
 Conclusion:  
 the maximum differential is  $22 - 4 = 18$  bar,  
 the minimum differential is  $22 - 19 = 3$  bar.

# Electromechanical pressure and vacuum switches

XML range

## Operating curves: Dual-Stage, Fixed Differential, Detection at Each Threshold (switching on rising pressure)

Adjustment ranges of the operating points PH1 and PH2 on rising pressure

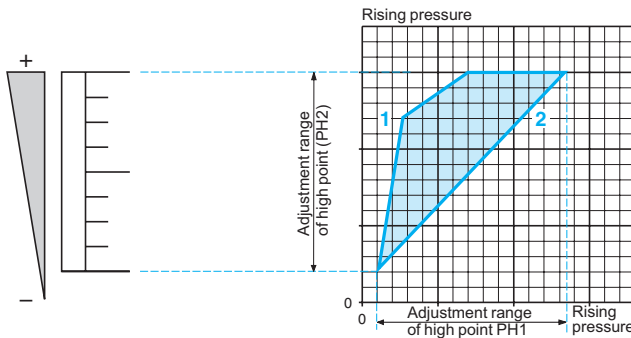

Defined by the difference between the minimum and maximum high point setting values of each stage (PH1 and PH2).

Operating point PH2 on rising pressure

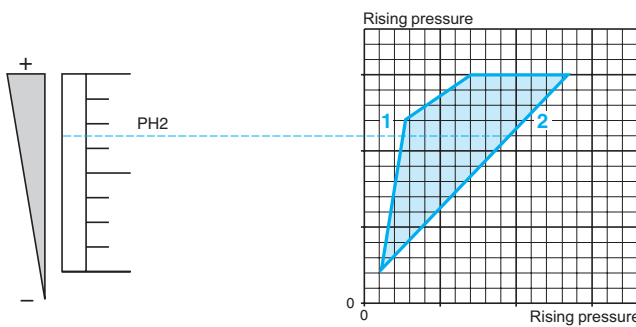

The upper pressure setting at which the pressure or vacuum switch actuates contact 2 on rising pressure. Adjustable throughout the range on rising pressure.

Operating point PH1 on rising pressure

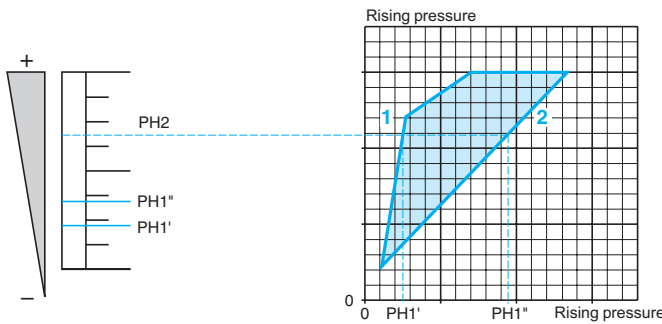

The upper pressure setting at which the pressure or vacuum switch actuates contact 1 on rising pressure.

Spread

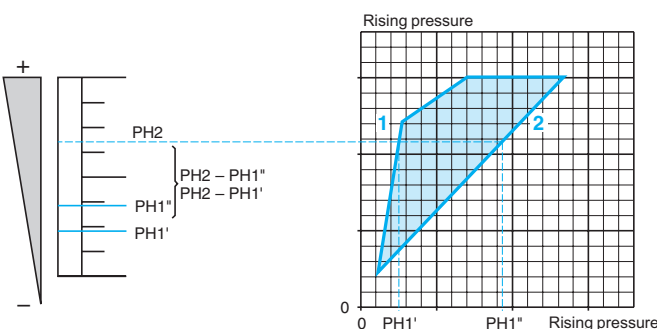

PH1 < PH2  
 PH2 - PH1' = maximum spread  
 PH2 - PH1'' = minimum spread

The difference between operating points PH2 and PH1 on rising pressure.

**Note:** operating point PH1 can be set at any value between PH1' and PH1''.

**Example:** Determining operating points on rising pressure for the two stages

- 1 Maximum spread
- 2 Minimum spread

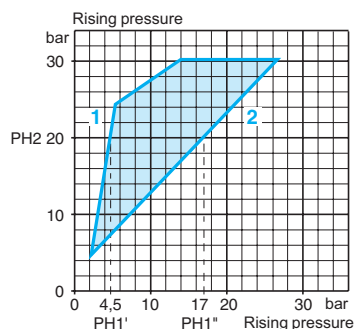

Second stage operating point on rising pressure (PH2) = 20 bar (set value at which contact 2 changes state on rising pressure). First stage operating point (PH1) can be set between 4.5 and 17 bar on rising pressure.

Conclusion:  
 the maximum spread is:  
 $20 - 4.5 = 15.5$  bar,  
 the minimum spread is:  
 $20 - 17 = 3$  bar.

# Electromechanical pressure and vacuum switches

XML range

## Operating curves: Dual-Stage, Fixed Differential, Detection at Each Threshold (switching on rising pressure)

**Adjustment range of high point (PH1 or PH2)**

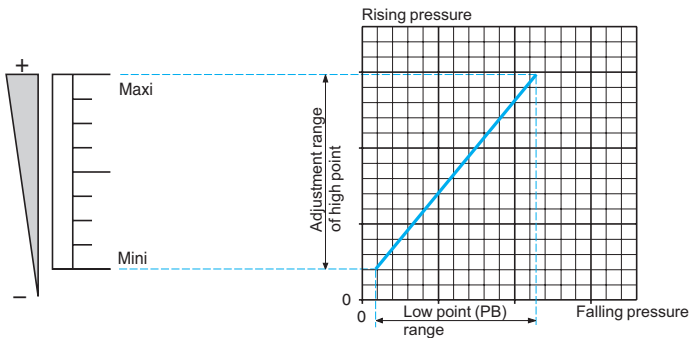

Defined by the difference between the minimum and maximum high point (PH1 or PH2) setting values for each stage.

For a high set point (PH1 or PH2), the lower point (PB1 or PB2) is fixed and cannot be adjusted.

For a low set point (PB1 or PB2), the higher point (PH1 or PH2) is fixed and cannot be adjusted.

**Operating point on rising pressure (PH1 or PH2)**

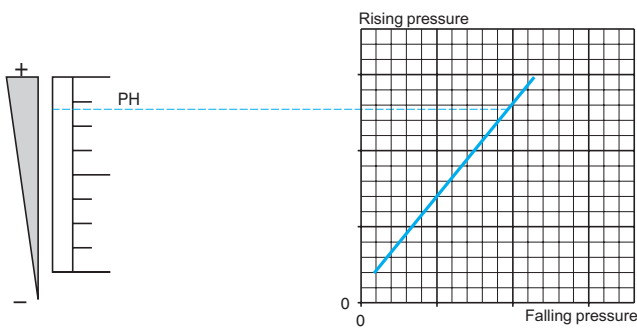

The upper pressure setting at which the pressure or vacuum switch actuates the contact, for each stage, on rising pressure. Adjustable throughout the range on rising pressure.

**Operating point on falling pressure (PB1 or PB2)**

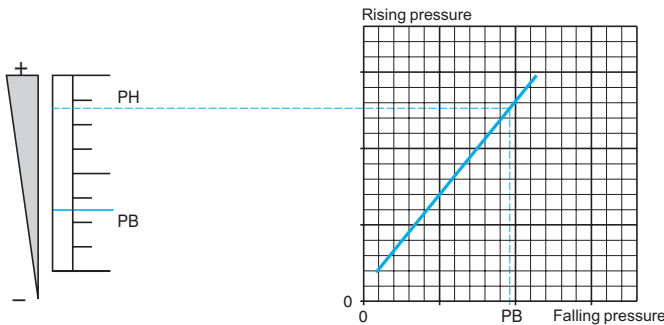

The pressure at which the switch contact changes state, for each stage, on falling pressure.

The lower point (PB) is not adjustable and is entirely dependent on the high point setting (PH) and the inherent differential of the switch.

**Differential**

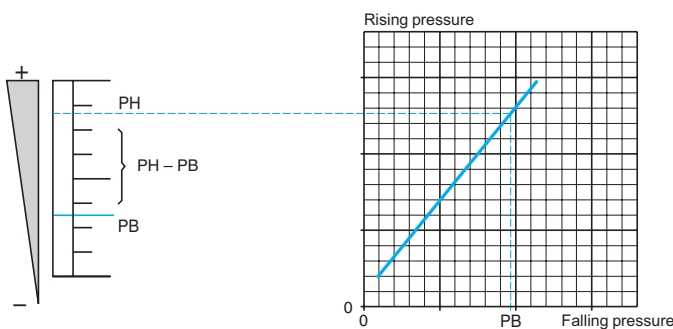

$PH - PB =$  inherent differential

The difference between the operating point on rising pressure (PH) and the operating point on falling pressure (PB), for each stage. This point is not adjustable, so the value of the differential is fixed. It is the inherent differential of the switch (contact differential, friction, etc.) for each of its two stages.

**Example:**  
 stage 1 = segment EF  
 stage 2 = segment GH

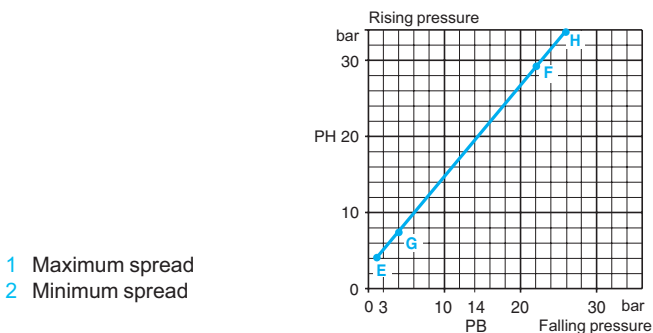

For stage 2 (segment GH):

Operating point on rising pressure (PH2) is 20 bar (set value at which contact 2 changes state on rising pressure). The operating point on falling pressure (PB2) is 14 bar (fixed value at which contact 2 returns to its original state).

Conclusion: for stage 2, the differential is:  $20 - 14 = 6$  bar.

Repeat the same procedure for stage 1 (segment EF).

- 1 Maximum spread
- 2 Minimum spread

# Electromechanical pressure and vacuum switches

## XML range

### Interpreting the reference for XML Devices

Example: XMLA004A2S13		XML	A	004	A	2	S	1	3
Designation		Commercial reference							
XML Pressure Switch		XML							
<b>Type</b>	Nonadjustable differential, single pole	A							
	Adjustable differential, single pole	B							
	Adjustable differential, double pole	C							
	Nonadjustable differential, double pole	D							
<b>Operating range bar (psi)</b>	0 to 0.05 (0 to 0.725)		L05						
	0 to 0.35 (0 to 5.075)		L35						
	0 to 0.35 (0 to 5.075)      Overpressure 0.30 (4.35)		S35						
	-1 to -0.28 (-14.5 to -4.06)		M01						
	-1 to -0.14 (-14.5 to -2.03)		M02						
	-0.2 to -0.02 (-2.9 to -0.029)		M03						
	-0.5 to 5 (-7.25 to 72.5)		M05						
	0 to 1 (0 to 14.5)		001						
	0 to 2.5 (0 to 36.25)		002						
	0 to 2.5 (0 to 36.25)      Overpressure 0.30 (4.35)		S02						
	0 to 4 (0 to 58)		004						
	0 to 4 (0 to 58)      Overpressure 0.30 (4.35)		S04						
	0 to 10 (0 to 145)		010						
	0 to 10 (0 to 145)      Overpressure 0.30 (4.35)		S10						
	0 to 20 (0 to 290)		020						
	0 to 20 (0 to 290)      Overpressure 0.30 (4.35)		S20						
	0 to 35 (0 to 507.5)		035						
	0 to 40 (0 to 580)		040						
	0 to 70 (0 to 1015)		070						
	0 to 160 (0 to 2320)		160						
0 to 300 (0 to 4350)		300							
0 to 500 (0 to 7250)		500							
<b>Input fluid</b>	<b>Pressure switch diaphragm type</b>								
	Hydraulic oils, air, fresh, or sea water, 32-158 °F (0-70 °C)				A				
	Hydraulic oils, air, fresh, or sea water, 32-320 °F (0-160 °C)				B				
	Corrosive fluid				C				
	Viscous products				P				
	Hydraulic oils or air, 32-140 °F (0-60 °C)				R				
	Fresh or sea water, 32-320 °F (0-160 °C)				S				
	<b>Vacuum switch diaphragm type</b>								
	Hydraulic oils, air, fresh or sea water, 32-158 °F (0-70 °C)				V				
	Hydraulic oils, air, fresh or sea water, 32-320 °F (0-160 °C)				T				
	<b>Pressure switch piston type</b>								
	Hydraulic oils or air, 32-320 °F (0-160 °C)				D				
Fresh or sea water, 32-320 °F (0-160 °C)				E					
Corrosive fluid, 32-320 °F (0-160 °C)				N					
<b>Display</b>	Without					1			
	With					2			
<b>Electrical connection</b>	Threaded hole						S		
	EN 175301-803-A connector (ex DIN 43650)						C		
	M12 threaded connector (Micro Change type)						D		
<b>Contact type</b>	Dry contact							1	
<b>Entry type</b>	<b>European</b>								
	Pressure	G 1/4 (BSP female) G 1-1/4 for viscous products (input fluid identifier = P)							1
	Electrical	Type 13 (Pg 13.5)							
	Pressure	G 1/4 (BSP female) G 1-1/4 for viscous products (input fluid identifier = P)							2
	Electrical	ISO M20							
	<b>U.S.A.</b>								
	Pressure	1/4"-18 NPTF							3
	Electrical	1/2"-14 NPT							
	<b>Japan</b>								
	Pressure	PT 1/4 (JIS B0203)							4
Electrical	1/2 in. PF (JIS B0202)								
<b>Options</b>	May indicate factory setting								...

**Size: -1 bar (-14.5 psi)**  
**Fixed differential, for detection of a single threshold**  
**1 C/O single-pole contact**

**XMLA vacuum switches** **With setting scale**

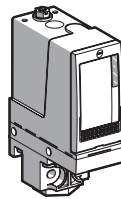

**Adjustable range of operating point (PB)**  
 (falling pressure) -0.28 to -1 bar (-4.06 to -14.5 psi)

**References**

<b>Fluids controlled</b> For materials in contact with fluid, see page 62	Hydraulic oils, fresh water, sea water, air, up to 158 °F (70 °C)	<b>XMLAM01V2S11</b>
<b>Pressure connection</b>		G 1/4-19 BSP
<b>Electrical connection</b>	Conduit/cable entry	Pg 13.5
	Terminals	1 x 0.2 to 2 x 2.5 mm <sup>2</sup> (1 x 24 to 2 x 14 AWG)
<b>Weight, lb (kg)</b>		1.51 (0.685)

**Supplementary specifications** (not shown under general specifications)

<b>Inherent differential</b> (add to PB to get PH)	At low setting	0.24 bar ±0.05 (3.48 psi ±0.72)
	At high setting	0.24 bar ±0.05 (3.48 psi ±0.72)
<b>Maximum allowable pressure</b>	Per cycle	5 bar (72.5 psi)
	Accidental	9 bar (130.5 psi)
<b>Destruction pressure</b>		18 bar (261 psi)
<b>Vacuum switch style</b>		Diaphragm

**Operating curves** **Connection**

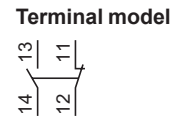
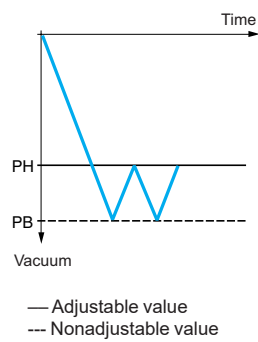
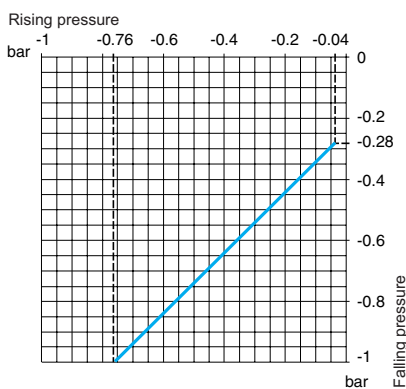

**Other versions** For switches with alternative tapped cable entries, please consult our Customer Care Center.

**Size: -1 bar (-14.5 psi)**  
**Adjustable differential, for regulation between two thresholds**  
**1 C/O single-pole contact**

**XMLB vacuum switches** **With setting scale**



**Adjustable range of operating point (PB)**  
(falling pressure) -0.14 to -1 bar (-2.03 to -14.5 psi)

**References**

<b>Fluids controlled</b> Hydraulic oils, fresh water, sea water, air, For materials in contact with fluid, see page 62 up to 158 °F (70 °C)	<b>XMLBM02V2S11</b>	<b>XMLBM02V2S12</b>	<b>XMLBM02V2C11</b>
<b>Pressure connection</b>	G 1/4-19 BSP		
<b>Electrical connection</b>	Conduit/cable entry Pg 13.5	ISO M20	DIN 43650A, 4-pin male
	Terminals 1 x 0.2 to 2 x 2.5 mm <sup>2</sup> (1 x 24 to 2 x 14 AWG)		For suitable female connector, see page 57.
<b>Weight, lb (kg)</b>	2.24 (1.015)		2.27 (1.030)

**Supplementary specifications (not shown under general specifications)**

<b>Possible differential</b> (add to PB to get PH)	Min. at low setting	0.13 bar ±0.02 (1.88 psi ±0.29)
	Min. at high setting	0.13 bar ±0.02 (1.88 psi ±0.29)
	Max. at high setting	0.8 bar (11.6 psi)
<b>Maximum allowable pressure</b>	Per cycle	5 bar (72.5 psi)
	Accidental	9 bar (130.5 psi)
<b>Destruction pressure</b>		18 bar (261 psi)
<b>Vacuum switch style</b>		Diaphragm

**Operating curves** **Connection**

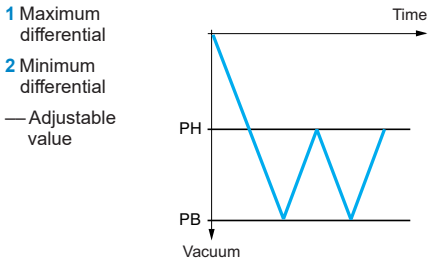
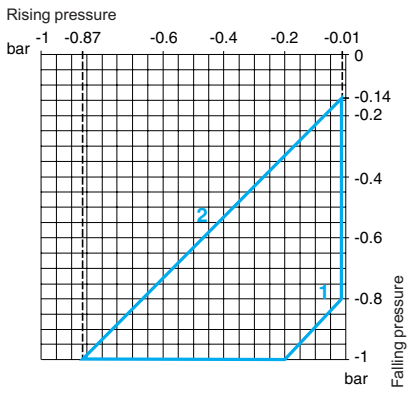

**Terminal model**



**Connector model**

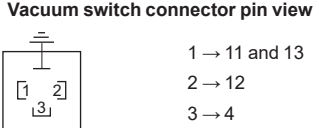

**Other versions** For switches with alternative tapped cable entries, please consult our Customer Care Center.

Size: -1 bar (-14.5 psi)  
 Dual-stage, fixed differential, for detection at each threshold  
 2 C/O single-pole contacts (one per stage)

**XMLD vacuum switches** Without setting scale

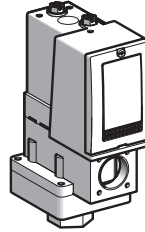

<b>Adjustable range of operating points</b> (falling pressure)	2nd stage operating point (PB2)	-0.12 to -1 bar (-1.74 to -14.5 psi)
	1st stage operating point (PB1)	-0.10 to -0.98 bar (-1.45 to -14.21 psi)
<b>Spread between the two stages (PB2—PB1)</b>		0.02 to 0.88 bar (0.29 to 12.76 psi)

**References**

<b>Fluids controlled</b> For materials in contact with fluid, see page 62	Hydraulic oils, fresh water, sea water, air, up to 158 °F (70 °C)	<b>XMLDM02V1S11</b>
<b>Pressure connection</b>		G 1/4-19
<b>Electrical connection</b>	Conduit/cable entry	Pg 13.5
	Terminals	1 x 0.2 to 2 x 2.5 mm <sup>2</sup> (1 x 24 to 2 x 14 AWG)
<b>Weight, lb (kg)</b>		2.24 (1.015)

**Supplementary specifications** (not shown under general specifications)

<b>Inherent differential</b> (add to PB1/PB2 to get PH1/PH2)	At low setting	0.1 bar ±0.035 (1.45 psi ±0.51)
	At high setting	0.1 bar ±0.02 (1.45 psi ±0.29)
<b>Maximum allowable pressure</b>	Per cycle	5 bar (72.5 psi)
	Accidental	9 bar (130.5 psi)
<b>Destruction pressure</b>		18 bar (261 psi)
<b>Vacuum switch style</b>		Diaphragm

**Operating curves**

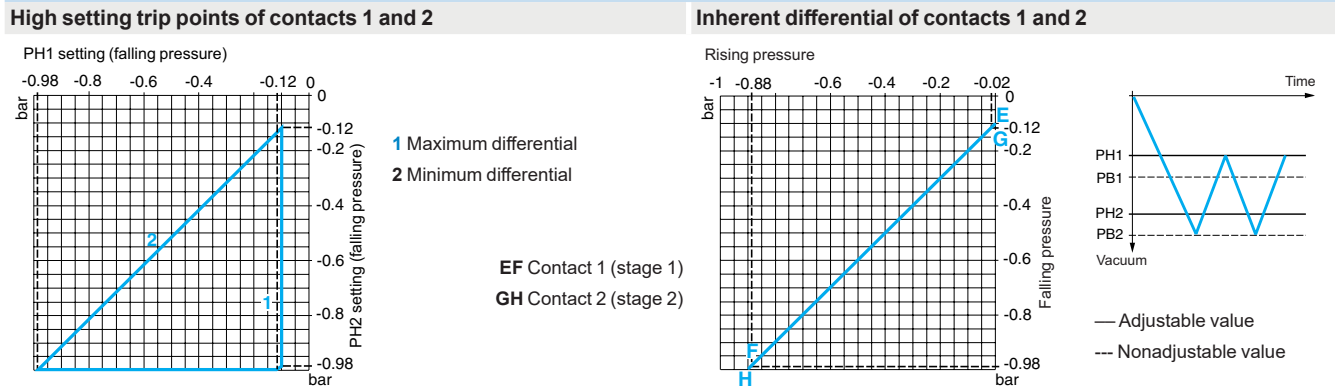

**Connection: Terminal model**

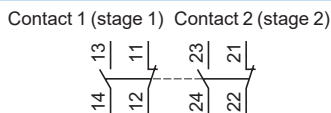

**Other versions** For switches with alternative tapped cable entries, please consult our Customer Care Center.

**Size 5 bar (72.5 psi)**  
**Adjustable differential, for regulation between two thresholds**  
**1 C/O single-pole contact**

**XMLB vacu-pressure switches** **With setting scale**

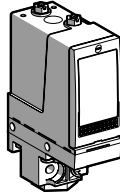

**Adjustable range of operating point (PH)** (rising pressure) -0.5 to 5 bar (-7.25 to 72.5 psi)

**References**

**Fluids controlled** Hydraulic oils, fresh water, sea water, air, up to 158 °F (70 °C) **XMLBM05A2S11**  
 For materials in contact with fluid, see page 62

**Pressure connection** G 1/4-19

**Electrical connection**  
 Conduit/cable entry Pg 13.5  
 Terminals 1 x 0.2 to 2 x 2.5 mm<sup>2</sup> (1 x 24 to 2 x 14 AWG)

**Weight, lb (kg)** 1.51 (0.685)

**Supplementary specifications (not shown under general specifications)**

**Possible differential** (subtract from PH to get PB)  
 Min. at low setting 0.5 bar ±0.05 (7.25 psi ±0.72)  
 Min. at high setting 0.5 bar ±0.05 (7.25 psi ±0.72)  
 Max. at high setting 6 bar (87 psi)

**Maximum allowable pressure**  
 Per cycle 6.25 bar (90.62 psi)  
 Accidental 11.25 bar (163.12 psi)

**Destruction pressure** 23 bar (333.5 psi)

**Vacu-pressure switch style** Diaphragm

**Operating curves**

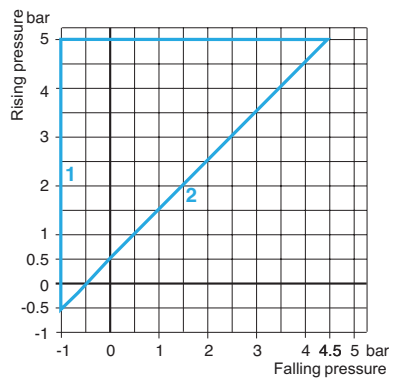

1 Maximum differential  
 2 Minimum differential  
 — Adjustable value

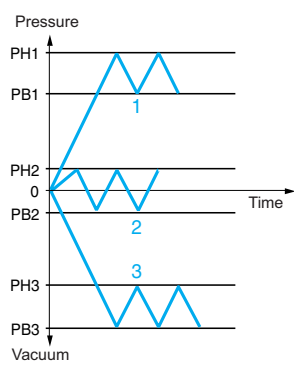

**Connection**

**Terminal model**



**Connector model**

**Vacu-pressure switch pin view**

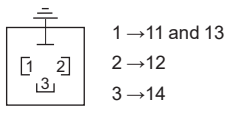

**Other versions** For switches with alternative tapped cable entries, please consult our Customer Care Center.



Size 350 mbar (5.07 psi)

Adjustable differential, for regulation between two thresholds

1 C/O single-pole contact

XMLB pressure switches	With setting scale	With setting scale overpressure 30 bar (435 psi)
------------------------	--------------------	---

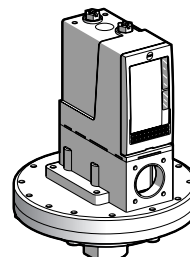
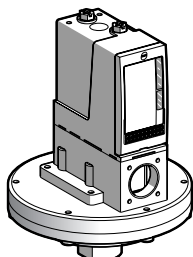

<b>Adjustable range of operating point (PH)</b> (rising pressure)	45–350 mbar (0.65–5.07 psi)	42–330 mbar (0.61–4.78 psi)
--	-----------------------------	--------------------------------

**References**

<b>Fluids controlled</b> Hydraulic oils, air, up to 320 °F (160 °C) For materials in contact with fluid, see page 62	<b>XMLBL35R2S13</b>	<b>XMLBL35R2S11</b>	<b>XMLBS35R2S11</b>	<b>XMLBS35R2S12</b>
--	---------------------	---------------------	---------------------	---------------------

<b>Pressure connection</b>	1/4" -18 NPTF	G 1/4-19		
----------------------------	---------------	----------	--	--

<b>Electrical connection</b>	Conduit/cable entry	1/2" NPT	Pg 13.5	Pg 13.5	ISO M20
	Terminals	1 x 0.2 to 2 x 2.5 mm <sup>2</sup> (1 x 24 to 2 x 14 AWG)		1 x 0.2 to 2 x 2.5 mm <sup>2</sup> (1 x 24 to 2 x 14 AWG)	

<b>Weight, lb (kg)</b>	5.68 (2.575)	7.72 (3.500)
------------------------	--------------	--------------

**Supplementary specifications (not shown under general specifications)**

<b>Possible differential</b> (subtract from PH to get PB)	Min. at low setting	42 mbar –8, +3 (0.60 psi –0.12, +0.04)	33 mbar –8, +3 (0.48 psi –0.12, +0.04)
	Min. at high setting	50 mbar ±8 (0.72 psi ±0.11)	58 mbar ±8 (0.84 psi ±0.11)
	Max. at high setting	300 mbar (4.35 psi)	250 mbar (3.62 psi)

<b>Maximum allowable pressure</b>	Per cycle	1.25 bar (18.12 psi)	30 bar (435 psi)
	Accidental	2.25 bar (32.62 psi)	37.5 bar (543.75 psi)

<b>Destruction pressure</b>	4.5 bar (65.25 psi)	67.5 bar (978.75 psi)
-----------------------------	---------------------	-----------------------

<b>Pressure switch style</b>	Diaphragm
------------------------------	-----------

**Operating curves**

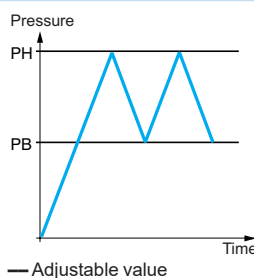
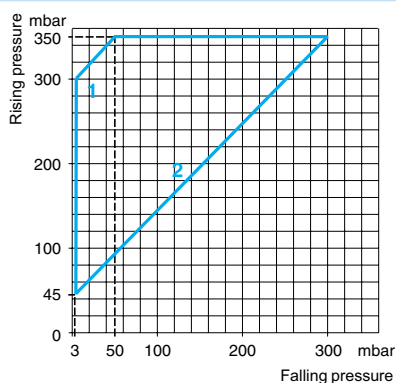

- 1 Maximum differential
- 2 Minimum differential

**Connection**

**Terminal model**



**Other versions** For switches with alternative tapped cable entries, please consult our Customer Care Center.

**Size 350 mbar (5.07 psi)**  
Adjustable differential, for regulation between two thresholds  
2 C/O single-pole contacts

**XMLC pressure switches** **With setting scale**  
overpressure 30 bar (435 psi)

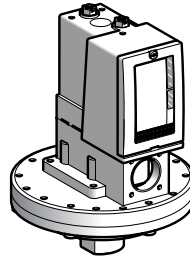

**Adjustable range of operating point (PH)**  
(rising pressure) 42–330 mbar (0.61–4.78 psi)

**References**

<b>Fluids controlled</b> For materials in contact with fluid, see page 62	Hydraulic oils, air, up to 320 °F (160 °C)	<b>XMLCS35R2S13</b>	<b>XMLCS35R2S11</b>	<b>XMLCS35R2S12</b>
<b>Pressure connection</b>		1/4"-18 NPTF	G 1/4-19	
<b>Electrical connection</b>	Conduit/cable entry	1/2" NPT	Pg 13.5	ISO M20
	Terminals	1 x 0.2 to 2 x 2.5 mm <sup>2</sup> (1 x 24 to 2 x 14 AWG)		
<b>Weight, lb (kg)</b>	7.72 (3.500)			

**Supplementary specifications (not shown under general specifications)**

<b>Possible differential</b> (subtract from PH to get PB)	Min. at low setting	40 mbar ±20 (0.58 psi ±0.29)
	Min. at high setting	88 mbar ±20 (1.27 psi ±0.29)
	Max. at high setting	230 mbar (3.33 psi)
<b>Maximum allowable pressure</b>	Per cycle	30 bar (435 psi)
	Accidental	37.5 bar (543.75 psi)
<b>Destruction pressure</b>		67.5 bar (978.75 psi)
<b>Pressure switch style</b>		Diaphragm

**Operating curves** **Connection**

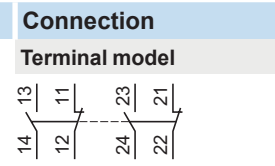
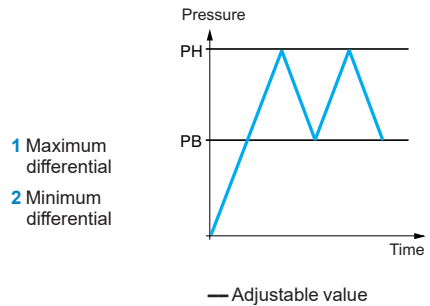
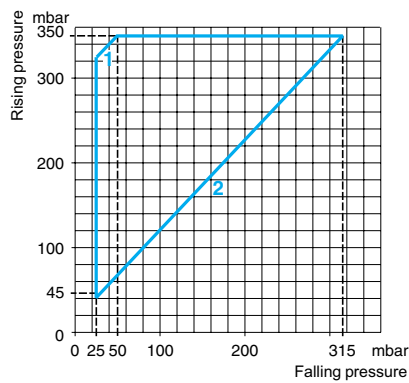

**Other versions** For switches with alternative tapped cable entries, please consult our Customer Care Center.

**Size 1 bar (14.5 psi)**  
**Fixed differential, for detection of a single threshold**  
**1 C/O single-pole contact**

**XMLA pressure switches** | **With setting scale**

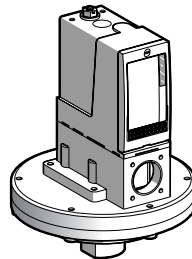

**Adjustable range of operating point (PH)**  
(rising pressure) | 0.03–1 bar (0.435–14.5 psi)

**References**

<b>Fluids controlled</b> For materials in contact with fluid, see page 62	Hydraulic oils, air, up to 320 °F (160 °C)	<b>XMLA001R2S11</b>
	Fresh water, sea water, corrosive fluids, up to 320 °F (160 °C)	<b>XMLA001S2S11</b>

**Pressure connection** | G 1/4-19

**Electrical connection** | Conduit/cable entry Pg 13.5  
Terminals 1 x 0.2 to 2 x 2.5 mm<sup>2</sup> (1 x 24 to 2 x 14 AWG)

**Weight, lb (kg)** | 5.63 (2.555)

**Supplementary specifications (not shown under general specifications)**

**Inherent differential** | At low setting 0.02 bar ±0.01 (0.29 psi ±0.14)  
(subtract from PH to get PB) | At high setting 0.04 bar ±0.01 (0.58 psi ±0.14)

**Maximum allowable pressure** | Per cycle 1.25 bar (18.12 psi)  
Accidental 2.25 bar (32.62 psi)

**Destruction pressure** | 4.5 bar (65.25 psi)

**Pressure switch style** | Diaphragm

**Operating curves** | **Connection**

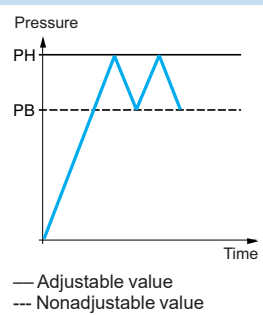
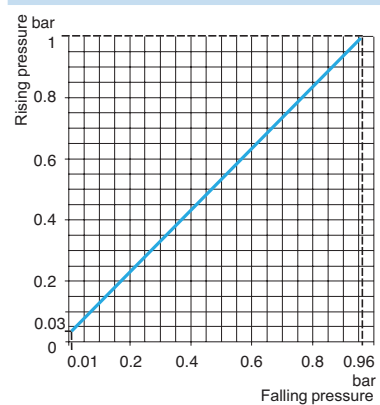

**Terminal model**



**Other versions** | For switches with alternative tapped cable entries, please consult our Customer Care Center.

**Size 1 bar (14.5 psi)**  
**Adjustable differential, for regulation between two thresholds**  
**1 C/O single-pole contact**

**XMLB pressure switches** **With setting scale**

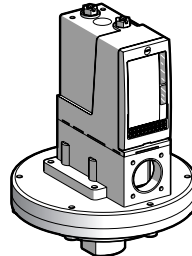

<b>Adjustable range of operating point (PH)</b> (rising pressure)	0.05–1 bar (0.72–14.5 psi)	
<b>Electrical connection</b>	Terminals	
<b>References</b>		
<b>Fluids controlled</b> For materials in contact with fluid, see page 62	Hydraulic oils, air, up to 320 °F (160 °C)	<b>XMLB001R2S11</b>
	Fresh water, sea water, corrosive fluids, up to 320 °F (160 °C)	— <b>XMLB001S2S12</b>
<b>Pressure connection</b>	G 1/4-19	
<b>Electrical connection</b>	Conduit/cable entry	Pg 13.5 ISO M20
	Terminals	1 x 0.2 to 2 x 2.5 mm <sup>2</sup> (1 x 24 to 2 x 14 AWG)
<b>Weight, lb (kg)</b>	5.68 (2.575)	
<b>Supplementary specifications (not shown under general specifications)</b>		
<b>Possible differential</b> (subtract from PH to get PB)	Min. at low setting	0.04 bar ±10 (0.58 psi ±0.14)
	Min. at high setting	0.06 bar ±20 (0.87 psi ±0.29)
	Max. at high setting	0.75 bar (10.87 psi)
<b>Maximum allowable pressure</b>	Per cycle	1.25 bar (18.12 psi)
	Accidental	2.25 bar (32.62 psi)
<b>Destruction pressure</b>	4.5 bar (65.25 psi)	
<b>Pressure switch style</b>	Diaphragm	

**Operating curves** **Connection**

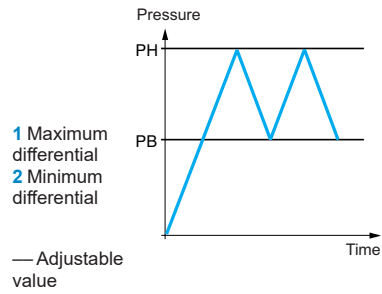
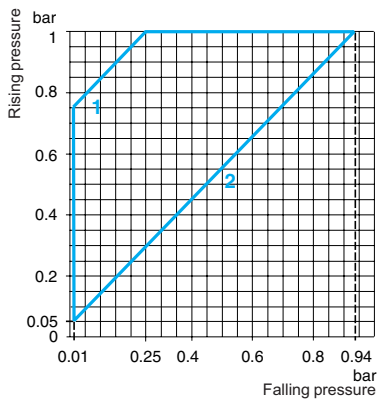

**Terminal model**



**Other versions** For switches with alternative tapped cable entries, please consult our Customer Care Center.

**Size 2.5 bar (36.25 psi)**  
**Fixed differential, for detection of a single threshold**  
**1 C/O single-pole contact**

**XMLA pressure switches** **With setting scale**

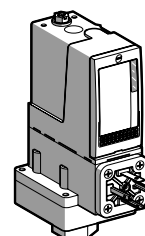
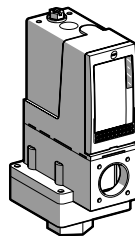

**Adjustable range of operating point (PH)**  
 (rising pressure) 0.15–2.5 bar (2.17–36.25 psi)

**References**

<b>Fluids controlled</b> For materials in contact with fluid, see page 62.	Hydraulic oils, fresh water, sea water, air, up to 158 °F (70 °C)	<b>XMLA002A2S11</b>	<b>XMLA002A2S12</b>	<b>XMLA002A2C11</b>
	Corrosive fluids, up to 320 °F (160 °C)	<b>XMLA002C2S11</b>	–	–
<b>Pressure connection</b>		G 1/4-19		
<b>Electrical connection</b>	Conduit/cable entry	Pg 13.5	ISO M20	DIN 43650A, 4-pin male
	Terminals	1 x 0.2 to 2 x 2.5 mm <sup>2</sup> (1 x 24 to 2 x 14 AWG)		For suitable female connector, see page 57.
<b>Weight, lb (kg)</b>		2.19 (0.995)		2.23 (1.010)

**Supplementary specifications (not shown under general specifications)**

<b>Inherent differential</b> (subtract from PH to get PB)	At low setting	0.13 bar ±0.03 (1.88 psi ±0.43)
	At high setting	0.13 bar ±0.03 (1.88 psi ±0.43)
<b>Maximum allowable Pressure</b>	Per cycle	5 bar (72.5 psi)
	Accidental	9 bar (130.5 psi)
<b>Destruction pressure</b>		18 bar (261 psi)
<b>Pressure switch style</b>		Diaphragm

**Operating curves** **Connection**

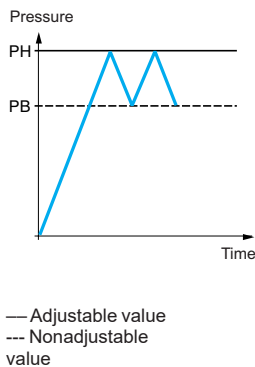
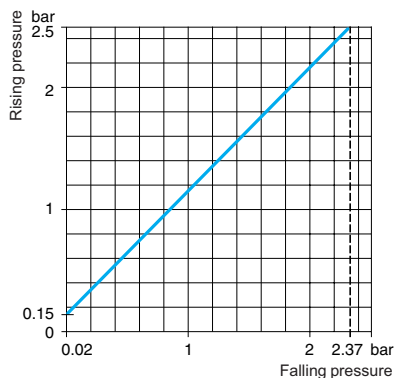

**Terminal model**



**Connector model**

**Pressure switch connector pin view**

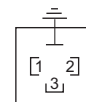

- 1 → 11 and 13
- 2 → 12
- 3 → 14

**Other versions** For switches with alternative tapped cable entries, please consult our Customer Care Center.

**Size 2.5 bar (36.25 psi)**  
**Adjustable differential, for regulation between two thresholds**  
**1 C/O single-pole contact**

<b>XMLB pressure switches</b>	<b>With setting scale</b>	<b>With setting scale overpressure 30 bar (435 psi)</b>
-------------------------------	---------------------------	---

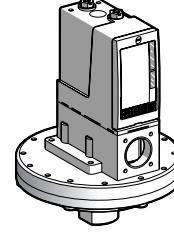
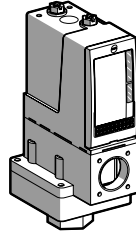

<b>Adjustable range of operating point (PH) (rising pressure)</b>	0.3–2.5 bar (4.35–36.25 psi)
---	------------------------------

**References**

<b>Fluids controlled</b> For materials in contact with fluid, see page 62.	Hydraulic oils, fresh water, sea water, air, up to 158 °F (70 °C)	<b>XMLB002A2S11</b>	<b>XMLB002A2S12</b>	—
	Hydraulic oils, fresh water, sea water, air, up to 320 °F (160 °C)	<b>XMLB002B2S11</b>	—	—
	Hydraulic oils, fresh water, air, up to 320 °F (160 °C)	—	—	<b>XMLBS02B2S11</b>

<b>Pressure connection</b>	G 1/4-19			
<b>Electrical connection</b>	Conduit/cable entry	Pg 13.5	ISO M20	Pg 13.5
	Terminals	1 x 0.2 – 2 x 2.5 mm <sup>2</sup> (1 x 24 to 2 x 14 AWG)	1 x 0.2 – 2 x 2.5 mm <sup>2</sup> (1 x 24 to 2 x 14 AWG)	1 x 0.2 – 2 x 2.5 mm <sup>2</sup> (1 x 24 to 2 x 14 AWG)
<b>Weight, lb (kg)</b>	2.24 (1.015)	2.24 (1.015)	7.72 (3.500)	

**Supplementary specifications (not shown under general specifications)**

<b>Possible differential</b> (subtract from PH to get PB)	Min. at low setting	0.16 bar, –0.8 mbar, +1.1 mbar (2.32 psi, –0.01, +0.02)	0.1 bar –0.8 mbar, +1.1 mbar (1.45 psi –0.01, +0.02)
	Min. at high setting	0.21 bar ±1.4 mbar (3.04 psi ±0.02)	0.22 bar ±1.4 mbar (3.19 psi ±0.02)
	Max. at high setting	1.75 bar (25.37 psi)	1.45 bar (21 psi)
<b>Maximum allowable pressure</b>	Per cycle	5 bar (72.5 psi)	30 bar (435 psi)
	Accidental	9 bar (130.5 psi)	37.5 bar (543.75 psi)
<b>Destruction pressure</b>	18 bar (261 psi)	67.5 bar (978.75 psi)	
<b>Pressure switch style</b>	Diaphragm		

**Operating curves**

The graph plots Rising pressure (bar) on the y-axis (0 to 2.5) against Falling pressure (bar) on the x-axis (0 to 2.29). A diagonal line represents the pressure path. Two horizontal dashed lines indicate adjustable values. The vertical distance between these lines is labeled '1' (Maximum differential). The vertical distance from the lower line to the diagonal is labeled '2' (Minimum differential).

The graph plots Pressure on the y-axis against Time on the x-axis. It shows a sawtooth wave representing pressure fluctuations. Two horizontal lines are shown: PH (Pressure High) and PB (Pressure Break). The wave crosses PH and then PB. A legend indicates that the horizontal lines represent 'Adjustable value'.

**Connection**

**Terminal model**

The terminal model diagram shows a rectangular terminal block with four pins. Pin 13 is at the top left, pin 11 is at the top right, pin 14 is at the bottom left, and pin 12 is at the bottom right.

**Other versions** For switches with alternative tapped cable entries, please consult our Customer Care Center.

**Size 2.5 bar (36.25 psi)**  
**Adjustable differential, for regulation between two thresholds**  
**2 C/O single-pole contacts**

XMLC pressure switches	With setting scale	With setting scale overpressure 30 bar (435 psi)
------------------------	--------------------	--

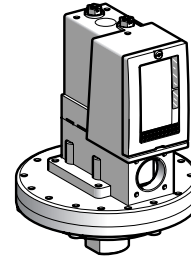
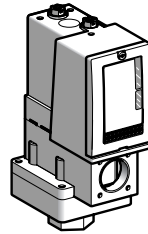

**Adjustable range of operating point (PH)**  
(rising pressure) | 0.3–2.5 bar (4.35–36.25 psi)

References						
<b>Fluids controlled</b> Hydraulic oils, fresh water, air, up to 320 °F (160 °C) For materials in contact with fluid, see page 62.	Hydraulic oils, fresh water, air, up to 320 °F (160 °C)	—	—	XMLCS02B2S13	XMLCS02B2S11	XMLCS02B2S12
	Hydraulic oils, fresh water, sea water, air, up to 320 °F (160 °C)	XMLC002B2S11	XMLC002B2S12	—	—	—
<b>Pressure connection</b>	G 1/4-19		1/4"-18 NPTF		G 1/4-19	
<b>Electrical connection</b>	Conduit/cable entry	Pg 13.5	ISO M20	1/2" NPT	Pg 13.5	ISO M20
	Terminals	1 x 0.2 to 2 x 2.5 mm <sup>2</sup> (1 x 24 to 2 x 14 AWG)				
<b>Weight, lb (kg)</b>	2.19 (0.995)			7.72 (3.500)		

Supplementary specifications (not shown under general specifications)			
<b>Possible differential</b> (subtract from PH to get PB)	Min. at low setting	0.13 bar ±0.02 (1.89 psi ±0.29)	0.1 bar ±0.02 (1.45 psi ±0.29)
	Min. at high setting	0.17 bar ±0.03 (2.47 psi ±0.43)	0.18 bar ±0.03 (2.61 psi ±0.43)
	Max. at high setting	2 bar (29 psi)	1.25 bar (18.12 psi)
<b>Maximum allowable pressure</b>	Per cycle	5 bar (72.5 psi)	30 bar (435 psi)
	Accidental	9 bar (130.5 psi)	37.5 bar (543.75 psi)
<b>Destruction pressure</b>	18 bar (261 psi)		67.5 bar (978.75 psi)
<b>Pressure switch style</b>	Diaphragm		

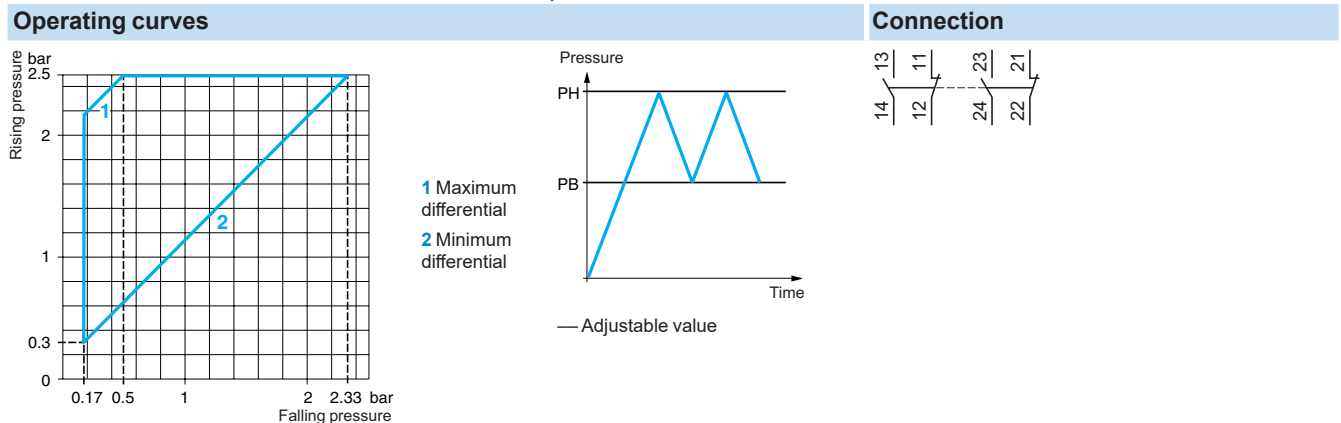

**Other versions** For switches with alternative tapped cable entries, please consult our Customer Care Center.

**Size 4 bar (58 psi)**  
**Fixed differential, for detection of a single threshold**  
**1 C/O single-pole contact**

**XMLA pressure switches** **With setting scale**

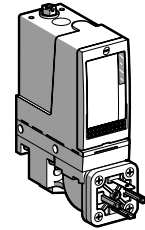
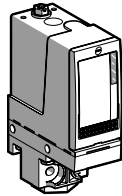

<b>Adjustable range of operating point (PH)</b> (rising pressure)	0.4–4 bar (5.8–58 psi)
--	------------------------

**References**

<b>Fluids controlled</b> For materials in contact with fluid, see page 62.	Hydraulic oils, fresh water, sea water, air, up to 158 °F (70 °C)	<b>XMLA004A2S13</b>	<b>XMLA004A2S11</b>	<b>XMLA004A2S12</b>	<b>XMLA004A2C11</b>
	Hydraulic oils, fresh water, sea water, air, up to 320 °F (160 °C)	—	<b>XMLA004B2S11</b>	—	—
	Corrosive fluids, up to 320 °F (160 °C)	—	<b>XMLA004C2S11</b>	—	—

<b>Pressure connection</b>	1/4"-18 NPTF	G 1/4-19		
<b>Electrical connection</b>	Conduit/cable entry	1/2" NPT	Pg 13.5	ISO M20
	Terminals	1 x 0.2 to 2 x 2.5 mm <sup>2</sup> (1 x 24 to 2 x 14 AWG)		DIN 43650A, 4-pin male
<b>Weight, lb (kg)</b>	1.51 (0.685)			1.58 (0.715)

**Supplementary specifications (not shown under general specifications)**

<b>Inherent differential</b> (subtract from PH to get PB)	At low setting	0.35 bar ±0.03 (5.07 psi ±0.43)
	At high setting	0.35 bar ±0.03 (5.07 psi ±0.43)
<b>Maximum allowable pressure</b>	Per cycle	5 bar (72.5 psi)
	Accidental	9 bar (130.5 psi)
<b>Destruction pressure</b>		18 bar (261 psi)
<b>Pressure switch style</b>		Diaphragm

**Operation curves** **Connection**

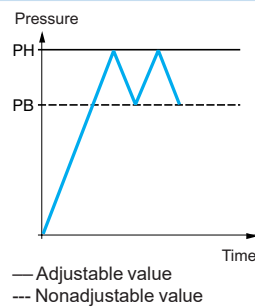
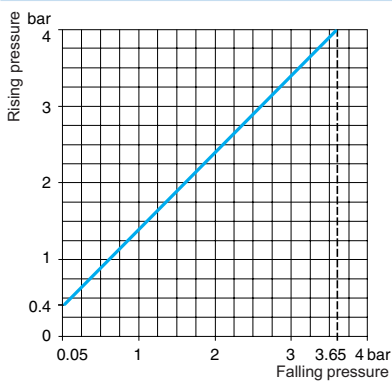

**Terminal model**



**Connector model**

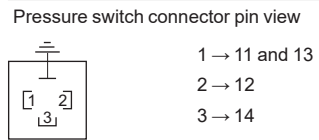

**Other versions** For switches with alternative tapped cable entries, please consult our Customer Care Center.



**Size 4 bar (58 psi)**  
**Adjustable differential, for regulation between 2 thresholds**  
**1 C/O single-pole contact**

<b>XMLB pressure switches</b>	<b>With setting scale</b>	<b>With setting scale overpressure 30 bar (435 psi)</b>
-------------------------------	---------------------------	---

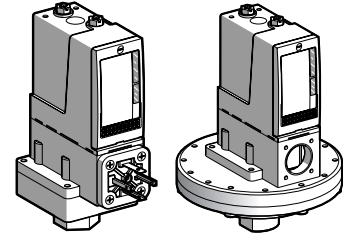
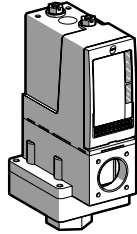

**Adjustable range of operating point (PH)**  
(rising pressure) 0.25–4 bar (3.62–58 psi)

References		XMLB004A2S13	XMLB004A2S11	XMLB004A2S12	XMLB004A2C11		
<b>Fluids controlled</b> Hydraulic oils, fresh water, sea water, air, up to 158 °F (70 °C) For materials in contact with fluid, see page 62.	Hydraulic oils, fresh water, sea water, air, up to 320 °F (160 °C)		XMLB004B2S11				
	Hydraulic oils, freshwater, air, up to 320 °F (160 °C)					XMLBS04B2S11	XMLBS04B2S12

<b>Pressure connection</b>		1/4"-18 NPTF	G 1/4-19				
<b>Electrical connection</b>	Conduit/cable entry	1/2" NPT	Pg 13.5	ISO M20	DIN 43650A, 4-pin male	Pg 13.5	ISO M20
	Terminals	1 x 0.2 to 2 x 2.5 mm <sup>2</sup> (1 x 24 to 2 x 14 AWG)			For suitable female connector, see page 57.	1 x 0.2 to 2 x 2.5 mm <sup>2</sup> (1 x 24 to 2 x 14 AWG)	
<b>Weight, lb (kg)</b>		2.24 (1.015)			2.27 (1.030)	7.72 (3.500)	

Supplementary specifications (not shown under general specifications)			
<b>Possible differential</b> (subtract from PH to get PB)	Min. at low setting	0.2 bar ±0.01 (2.9 psi ±0.14)	
	Min. at high setting	0.25 bar, -0.03, +0.05 (3.62 psi, -0.43, +0.72)	
	Max. at high setting	2.4 bar (34.8 psi)	
<b>Maximum allowable pressure</b>	Per cycle	5 bar (72.5 psi)	
	Accidental	9 bar (130.5 psi)	
<b>Destruction pressure</b>		18 bar (261 psi)	
<b>Pressure switch style</b>		Diaphragm	

**Operating curves**

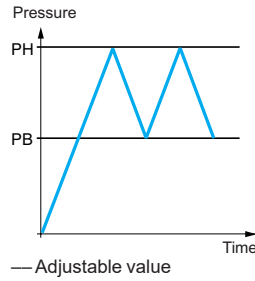
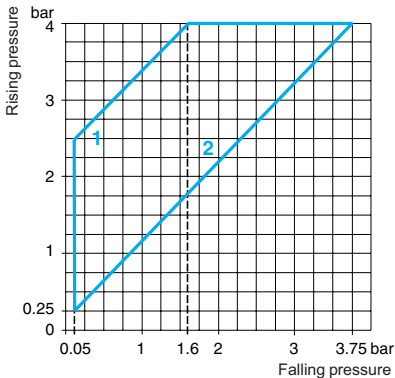

- 1 Maximum differential
- 2 Minimum differential

**Connection**

**Terminal model**



**Connector model**

**Pressure switch connector pin view**



- 1 → 11 and 13
- 2 → 12
- 3 → 14

**Other versions** For switches with alternative tapped cable entries, please consult our Customer Care Center.

**Size 4 bar (58 psi)**  
**Adjustable differential, for regulation between two thresholds**  
**2 C/O single-pole contacts**

XMLC pressure switches	With setting scale	With setting scale overpressure 30 bar (435 psi)
------------------------	--------------------	---

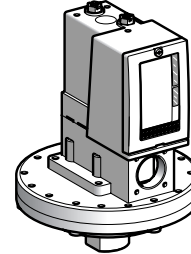
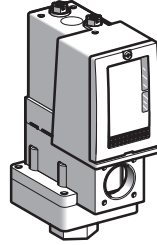

**Adjustable range of operating point (PH)**  
(rising pressure) 0.3–4 bar (4.35–58 psi)

References					
<b>Fluids controlled</b> For materials in contact with fluid, see page 62.	Hydraulic oils, fresh water, air, up to 320 °F (160 °C)	—	—	<b>XMLCS04B2S11</b>	<b>XMLCS04B2S12</b>
	Hydraulic oils, fresh water, sea water, air, up to 320 °F (160 °C)	<b>XMLC004B2S11</b>	<b>XMLC004B2S12</b>	—	—
<b>Pressure connection</b>	G 1/4-19				
<b>Electrical connection</b>	Conduit/cable entry	Pg 13.5	ISO M20	Pg 13.5	ISO M20
	Terminals	1 x 0.2 to 2 x 2.5 mm <sup>2</sup> (1 x 24 to 2 x 14 AWG)			
<b>Weight, lb (kg)</b>	1.51 (0.685)		7.72 (3.500)		

Supplementary specifications (not shown under general specifications)					
<b>Possible differential</b> (subtract from PH to get PB)	Min. at low setting	0.15 bar ±0.02 (2.18 psi ±0.29)		0.1 bar ±0.02 (1.45 psi ±0.29)	
	Min. at high setting	0.17 bar ±0.02 (2.47 psi ±0.29)		0.25 bar ±0.02 (3.62 psi ±0.29)	
	Max. at high setting	2.5 bar (36.25 psi)		2.20 bar (31.9 psi)	
<b>Maximum allowable pressure</b>	Per cycle	5 bar (72.5 psi)		30 bar (435 psi)	
	Accidental	9 bar (130.5 psi)		37.5 bar (543.75 psi)	
<b>Destruction pressure</b>	18 bar (261 psi)		67.5 bar (978.75 psi)		
<b>Pressure switch style</b>	Diaphragm				

Operating curves		Connection
<p>1 Maximum differential 2 Minimum differential</p>	<p>— Adjustable value</p>	<b>Terminal model</b> 

**Other versions** For switches with alternative tapped cable entries, please consult our Customer Care Center.

**Size 10 bar (145 psi)**  
**Fixed differential, for detection of a single threshold**  
**1 C/O single-pole contact**

**XMLA pressure switches** **With setting scale**

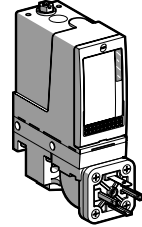
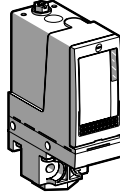

**Adjustable range of operating point (PH)**  
(rising pressure) | 0.6–10 bar (8.7–145 psi)

References					
<b>Fluids controlled</b> For materials in contact with fluid, see page 62.	Hydraulic oils, fresh water, sea water, air, up to 158 °F (70 °C)	<b>XMLA010A2S13</b>	<b>XMLA010A2S11</b>	<b>XMLA010A2S12</b>	<b>XMLA010A2C11</b>
	Hydraulic oils, fresh water, sea water, air, up to 320 °F (160 °C)	—	<b>XMLA010B2S11</b>	—	—
	Corrosive fluids, up to 320 °F (160 °C)	—	<b>XMLA010C2S11</b>	—	—
<b>Pressure connection</b>		1/4"-18 NPTF	G 1/4-19		
<b>Electrical connection</b>	Conduit/cable entry	1/2" NPT	Pg 13.5	ISO M20	DIN 43650A, 4-pin male
	Terminals	1 x 0.2 to 2 x 2.5 mm <sup>2</sup> (1 x 24 to 2 x 14 AWG)			For suitable female connector, see page 57.
<b>Weight, lb (kg)</b>		1.51 (0.685)			1.58 (0.715)

**Supplementary specifications (not shown under general specifications)**

<b>Inherent differential</b> (subtract from PH to get PB)	At low setting	0.5 bar ±0.05 (7.25 psi ±0.72)
	At high setting	0.5 bar ±0.05 (7.25 psi ±0.72)
<b>Maximum allowable pressure</b>	Per cycle	12.5 bar (181.25 psi)
	Accidental	22.5 bar (326.25 psi)
<b>Destruction pressure</b>		45 bar (652.5 psi)
<b>Pressure switch style</b>		Diaphragm

**Operating curves** **Connection**

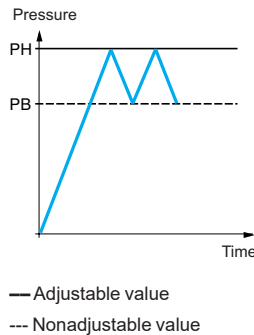
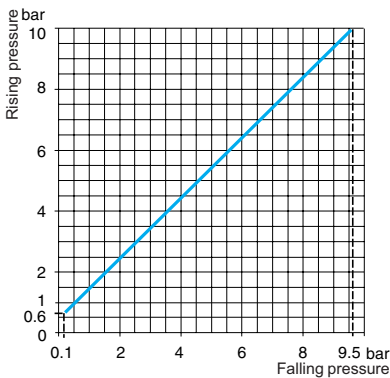

**Terminal model**



**Connector model**

**Pressure switch connector pin view**

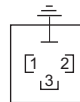

- 1 → 11 and 13
- 2 → 12
- 3 → 14

**Other versions** For switches with alternative tapped cable entries, please consult our Customer Care Center.

**Size 10 bar (145 psi)**  
**Adjustable differential, for regulation between two thresholds**  
**1 C/O single-pole contact**

**XMLB pressure switches** **With setting scale**

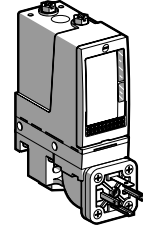
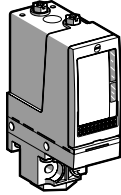

**Adjustable range of operating point (PH)**  
(rising pressure) 0.7–10 bar (10.15–145 psi)

References					
<b>Fluids controlled</b> For materials in contact with fluid, see page 62.	Hydraulic oils, fresh water, sea water, air, up to 158 °F (70 °C)	<b>XMLB010A2S13</b>	<b>XMLB010A2S11</b>	<b>XMLB010A2S12</b>	<b>XMLB010A2C11</b>
	Hydraulic oils, fresh water, air, up to 320 °F (160 °C)	—	<b>XMLB010B2S11</b>	—	—
	Corrosive fluids, up to 320 °F (160 °C)	—	<b>XMLB010C2S11</b>	—	<b>XMLB010C2C11</b>
<b>Pressure connection</b>		1/4"-18 NPTF	G 1/4-19		
<b>Electrical connection</b>	Conduit/cable entry	1/2" NPT	Pg 13.5	ISO M20	DIN 43650A, 4-pin male
	Terminals	1 x 0.2 to 2 x 2.5 mm <sup>2</sup> (1 x 24 to 2 x 14 AWG)			For suitable female connector, see page 57.
<b>Weight, lb (kg)</b>		1.55 (0.705)			1.62 (0.735)

Supplementary specifications (not shown under general specifications)		
<b>Possible differential</b> (subtract from PH to get PB)	Min. at low setting	0.57 bar ±0.05 (8.26 psi ±0.72).
	Min. at high setting	0.85 bar, -0.1, +0.15 (12.32 psi, -1.45, +2.17)
	Max. at high setting	7.5 bar (108.75 psi)
<b>Maximum allowable pressure</b>	Per cycle	12.5 bar (181.25 psi)
	Accidental	22.5 bar (326.25 psi)
<b>Destruction pressure</b>		45 bar (652.5 psi)
<b>Pressure switch style</b>		Diaphragm

**Operating curves**

**Connection**

**Terminal model**

**Connector model**

**Pressure switch connector pin view**

**Other versions** For switches with alternative tapped cable entries, please consult our Customer Care Center.

Size 10 bar (145 psi)

Adjustable differential, for regulation between two thresholds

2 C/O single-pole contacts

XMLC pressure switches	With setting scale	With setting scale overpressure 30 bar (435 psi)
------------------------	--------------------	---

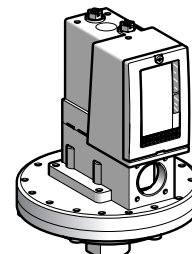
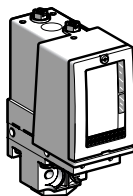

<b>Adjustable range of operating point (PH)</b> (rising pressure)	0.7–10 bar (10.15–145 psi)
--	----------------------------

### References

<b>Fluids controlled</b> For materials in contact with fluid, see page 62.	Hydraulic oils, fresh water, air, up to 158 °F (70 °C)	—	<b>XMLCS10A2S11</b>
	Hydraulic oils, fresh water, sea water, air, up to 320 °F (160 °C)	<b>XMLC010B2S11</b>	—
	Corrosive fluids, up to 320 °F (160 °C)	<b>XMLC010C2S11</b>	—

<b>Pressure connection</b>	G 1/4-19
----------------------------	----------

<b>Electrical connection</b>	Conduit/cable entry	Pg 13.5	Pg 13.5
	Terminals	1 x 0.2 to 2 x 2.5 mm <sup>2</sup> (1 x 24 to 2 x 14 AWG)	

<b>Weight, lb (kg)</b>	1.51 (0.685)	7.72 (3.500)
------------------------	--------------	--------------

### Supplementary specifications (not shown under general specifications)

<b>Possible differential</b> (subtract from PH to get PB)	Min. at low setting	0.45 bar ±0.05 (6.53 psi ±0.72)	0.25 bar ±0.05 (3.62 psi ±0.72)
	Min. at high setting	0.70 bar ±0.01 (10.15 psi ±1.45)	0.65 bar ±0.01 (9.42 psi ±1.45)
	Max. at high setting	8 bar (116 psi)	5.6 bar (81.2 psi)
<b>Maximum allowable pressure</b>	Per cycle	12.5 bar (181.25 psi)	30 bar (435 psi)
	Accidental	22.5 bar (326.25 psi)	37.5 bar (543.75 psi)
<b>Destruction pressure</b>		45 bar (652.5 psi)	67.5 bar (978.75 psi)

<b>Pressure switch style</b>	Diaphragm
------------------------------	-----------

### Operating curves

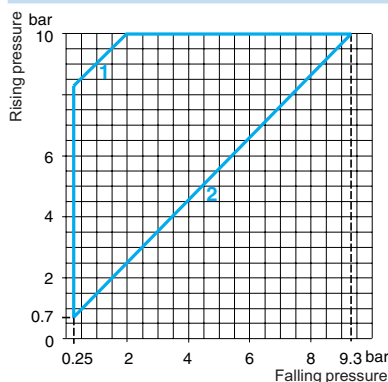

1 Maximum differential  
2 Minimum differential

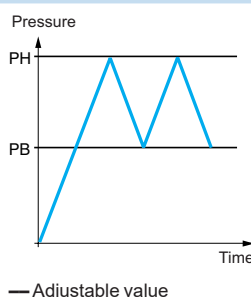

### Connection

#### Terminal model

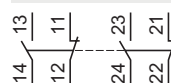

**Other versions** For switches with alternative tapped cable entries, please consult our Customer Care Center.

**Size 10 bar (145 psi)**  
**Dual-stage, fixed differential, for detection at each threshold**  
**2 C/O single-pole contacts (one per stage)**

**XMLD pressure switches** Without setting scale

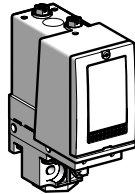

<b>Adjustable range of each operating point</b> (rising pressure)	2nd stage operating point (PH2)	1.2–10 bar (17.4–145 psi)
	1st stage operating point (PH1)	0.52–9.32 bar (7.54–135.14 psi)
<b>Spread between the two stages (PH2–PH1)</b>		0.68–5.8 bar (9.86–84.1 psi)

**References**

<b>Fluids controlled</b> For materials in contact with fluid, see page 62.	Hydraulic oils, fresh water, sea water, air, up to 320 °F (160 °C)	<b>XMLD010B1S11</b>
<b>Pressure connection</b>		G 1/4-19
<b>Electrical connection</b>	Conduit/cable entry	Pg 13.5
	Terminals	1 x 0.2 to 2 x 2.5 mm <sup>2</sup> (1 x 24 to 2 x 14 AWG)
<b>Weight, lb (kg)</b>		1.55 (0.705)

**Supplementary specifications** (not shown under general specifications)

<b>Inherent differential</b> (subtract from PH1/PH2 to get PB1/PB2)	At low setting	0.45 bar ±0.05 (6.53 psi ±0.72)
	At high setting	0.6 bar, ±0.1 (8.7 psi ±1.45)
<b>Maximum allowable pressure</b>	Per cycle	12.5 bar (181.25 psi)
	Accidental	22.5 bar (326.25 psi)
<b>Destruction pressure</b>		45 bar (652.5 psi)
<b>Pressure switch style</b>		Diaphragm

**Operating curves**

**High setting trip points of contacts 1 and 2**      **Inherent differential of contacts 1 and 2**

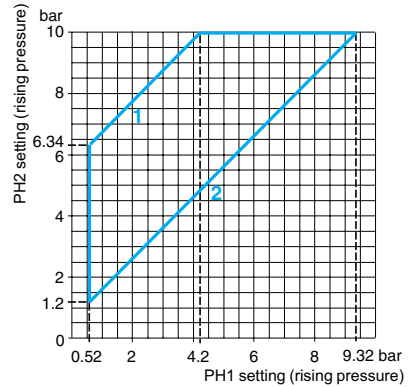

1 Maximum differential  
2 Minimum differential

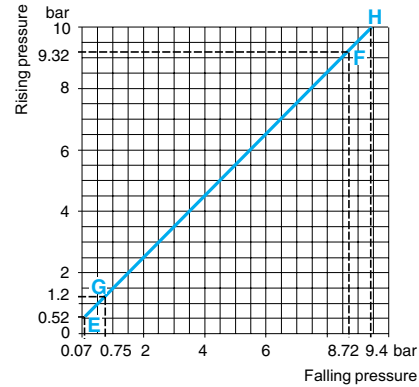

EF Contact 1 (stage 1)  
GH Contact 2 (stage 2)

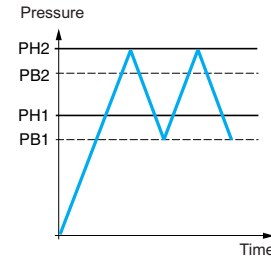

— Adjustable value  
--- Nonadjustable value

**Connection**  
**Terminal model**

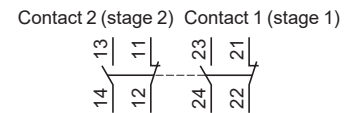

**Other versions** For switches with alternative tapped cable entries, please consult our Customer Care Center.

Size 20 bar (290 psi)

Fixed differential, for detection of a single threshold

1 C/O single-pole contact

### XMLA pressure switches

### With setting scale

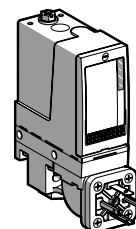
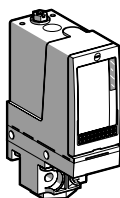

**Adjustable range of operating point (PH)**  
(rising pressure)

1–20 bar (14.5–290 psi)

### References

Fluids controlled		XMLA020A2S13	XMLA020A2S11	XMLA020A2S12	XMLA020A2C11
For materials in contact with fluid, see page 62.	Hydraulic oils, fresh water, sea water, air, up to 158 °F (70 °C)	—	XMLA020B2S11	XMLA020B2S12	XMLA020B2C11
	Hydraulic oils, fresh water, sea water, air, up to 320 °F (160 °C)	—	XMLA020C2S11	—	—
	Corrosive fluids, up to 320 °F (160 °C)	—	—	—	—

**Pressure connection**

1/4"-18 NPTF

G 1/4-19

**Electrical connection**

Conduit/cable entry

1/2" NPT

Pg 13.5

ISO M20

DIN 43650A, 4-pin male

Terminals

1 x 0.2 to 2 x 2.5 mm<sup>2</sup> (1 x 24 to 2 x 14 AWG)

For suitable female connector, see page 57.

**Weight, lb (kg)**

1.51 (0.685)

1.58 (0.715)

### Supplementary specifications (not shown under general specifications)

<b>Inherent differential</b> (subtract from PH to get PB)	At low setting	0.4 bar ±0.2 (5.8 psi ±2.9)
	At high setting	1 bar ±0.1 (14.5 psi ±1.45)
<b>Maximum allowable pressure</b>	Per cycle	25 bar (362.5 psi)
	Accidental	45 bar (652.5 psi)
<b>Destruction pressure</b>		90 bar (1305 psi)
<b>Pressure switch style</b>		Diaphragm

### Operating curves

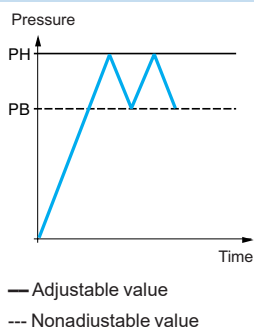
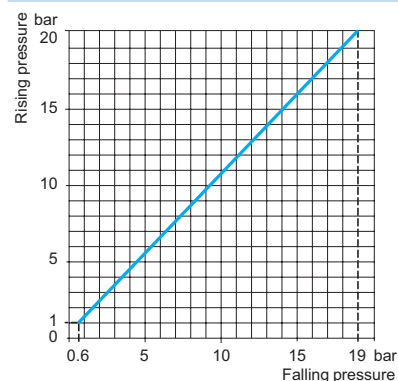

### Connection

#### Terminal model



#### Connector model

Pressure switch connector pin view

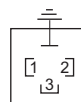

1 → 11 and 13  
2 → 12  
3 → 14

### Other versions

For switches with alternative tapped cable entries, please consult our Customer Care Center.

**Size 20 bar (290 psi)**  
**Adjustable differential, for regulation between two thresholds**  
**1 C/O single-pole contact**

**XMLB pressure switches** **With setting scale**

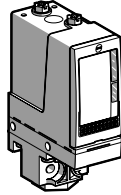

**Adjustable range of operating point (PH)**  
(rising pressure) 1.3–20 bar (18.9–290 psi)

**References**

<b>Fluids controlled</b> For materials in contact with fluid, see page 62	Hydraulic oils, fresh water, sea water, air, up to 158 °F (70 °C)	<b>XMLB020A2S13</b>	<b>XMLB020A2S11</b>	<b>XMLB020A2S12</b>
	Hydraulic oils, fresh water, air, up to 320 °F (160 °C)	—	<b>XMLB020B2S11</b>	—
	Corrosive fluids, up to 320 °F (160 °C)	—	<b>XMLB020C2S11</b>	<b>XMLB020C2S12</b>

**Pressure connection** 1/4"-18 NPTF G 1/4-19

**Electrical connection**  
Conduit/cable entry 1/2" NPT Pg 13.5 ISO M20  
Terminals 1 x 0.2 to 2 x 2.5 mm<sup>2</sup> (1 x 24 to 2 x 14 AWG)

**Weight, lb (kg)** 1.55 (0.705)

**Supplementary specifications (not shown under general specifications)**

<b>Possible differential</b> (subtract from PH to get PB)	Min. at low setting	1 bar ±0.25 (14.5 psi ±3.63)
	Min. at high setting	1.6 bar ±0.25 (23.20 psi ±3.63)
	Max. at high setting	11 bar (159.5 psi)
<b>Maximum allowable pressure</b>	Per cycle	25 bar (362.5 psi)
	Accidental	45 bar (652.5 psi)
<b>Destruction pressure</b>		90 bar (1305 psi)
<b>Pressure switch style</b>		Diaphragm

**Operating curves** **Connection**

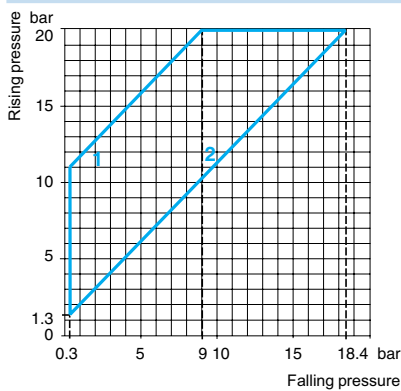

1 Maximum differential  
2 Minimum differential

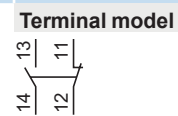
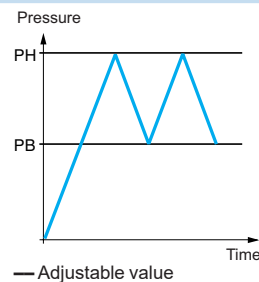

**Other versions** For switches with alternative tapped cable entries, please consult our Customer Care Center.



Size 20 bar (290 psi)

Adjustable differential, for regulation between two thresholds

2 C/O single-pole contacts

**XMLC pressure switches** **With setting scale**

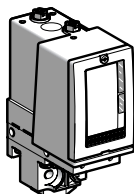

<b>Adjustable range of operating point (PH)</b> (rising pressure)	1.3–20 bar (18.85–290 psi)
--	----------------------------

**References**

<b>Fluids controlled</b> For materials in contact with fluid, see page 62	Hydraulic oils, fresh water, sea water, air, up to 320 °F (160 °C)	<b>XMLC020B2S11</b>	<b>XMLC020B2S12</b>
<b>Pressure connection</b>		G 1/4-19	
<b>Electrical connection</b>	Conduit/cable entry	Pg 13.5	ISO M20
	Terminals	1 x 0.2 to 2 x 2.5 mm <sup>2</sup> (1 x 24 to 2 x 14 AWG)	
<b>Weight, lb (kg)</b>	1.51 (0.685)		

**Supplementary specifications (not shown under general specifications)**

<b>Possible differential</b> (subtract from PH to get PB)	Min. at low setting	0.7 bar ±0.2 (10.15 psi ±2.9)
	Min. at high setting	1 bar ±0.2 (14.5 psi ±2.9)
	Max. at high setting	11 bar (159.5 psi)
<b>Maximum allowable pressure</b>	Per cycle	25 bar (362.5 psi)
	Accidental	45 bar (652.5 psi)
<b>Destruction pressure</b>	90 bar (1305 psi)	
<b>Pressure switch style</b>	Diaphragm	

**Operating curves** **Connection**

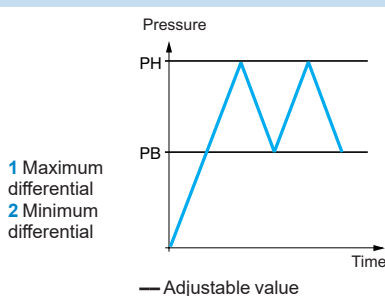
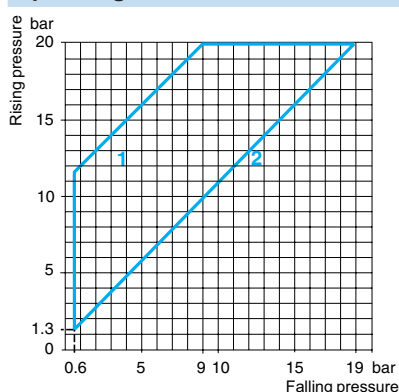

1 Maximum differential  
2 Minimum differential

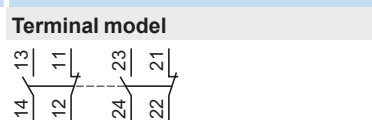

**Other versions** For switches with alternative tapped cable entries, please consult our Customer Care Center.

**Size 20 bar (290 psi)**  
**Dual-stage, fixed differential, for detection at each threshold**  
**2 C/O single-pole contacts (one per stage)**

**XMLD pressure switches** Without setting scale

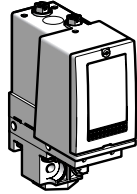

<b>Adjustable range of each operating point (rising pressure)</b>	2nd stage operating point (PH2) 1st stage operating point (PH1)	2.14-20 bar (31.03-290 psi) 0.9-18.76 bar (13.05-272.02 psi)
<b>Spread between the two stages (PH2-PH1)</b>		1.24-9.55 bar (17.98-138.48 psi)

**References**

<b>Fluids controlled</b> For materials in contact with fluid, see page 62.	Corrosive fluids, up to 320 °F (160 °C)	<b>XMLD020C1S12</b>
<b>Pressure connection</b>		G 1/4-19
<b>Electrical connection</b>	Conduit/cable entry	ISO M20
	Terminals	1 x 0.2 to 2 x 2.5 mm <sup>2</sup> (1 x 24 to 2 x 14 AWG)
<b>Weight, lb (kg)</b>		1.55 (0.705)

**Supplementary specifications (not shown under general specifications)**

<b>Inherent differential</b> (subtract from PH1/PH2 to get PB1/PB2)	At low setting At high setting	0.7 bar ±1.05 (10.15 psi ±2.18) 1.3 bar, ±0.3 (18.85 psi ±4.35)
<b>Maximum allowable pressure</b>	Per cycle Accidental	25 bar (362.5 psi) 45 bar (652.5 psi)
<b>Destruction pressure</b>		90 bar (1305 psi)
<b>Pressure switch style</b>		Diaphragm

**Operating curves**

**High setting trip points of contacts 1 and 2**      **Inherent differential of contacts 1 and 2**

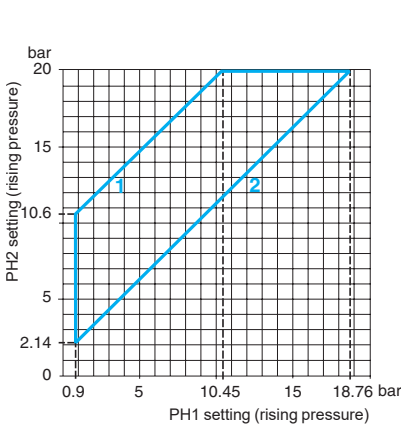

**1** Maximum differential  
**2** Minimum differential

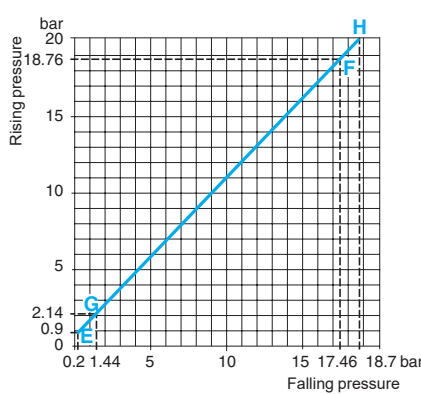

**EF** Contact 1 (stage 1)  
**GH** Contact 2 (stage 2)

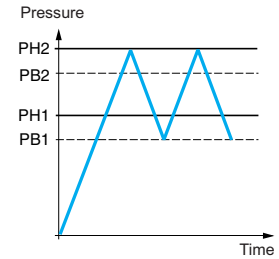

— Adjustable value  
--- Nonadjustable value

**Connection**  
**Terminal model**

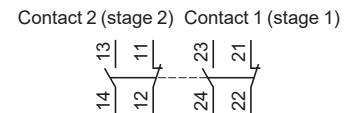

**Other versions** For switches with alternative tapped cable entries, please consult our Customer Care Center.

Size 35 bar (507.5 psi)

Fixed differential, for detection of a single threshold

1 C/O single-pole contact

**XMLA pressure switches** **With setting scale**

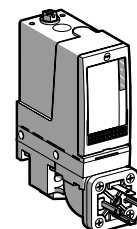
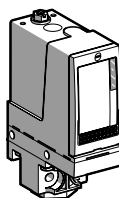

<b>Adjustable range of operating point (PH)</b> (rising pressure)	1.5-35 bar (21.75-507.5 psi)
--	------------------------------

**References**

<b>Fluids controlled</b> For materials in contact with fluid, see page 62.	Hydraulic oils, fresh water, sea water, air, up to 158 °F (70 °C)	<b>XMLA035A2S11</b>	<b>XMLA035A2S12</b>	<b>XMLA035A2C11</b>
	Hydraulic oils, fresh water, sea water, air, up to 320 °F (160 °C)	<b>XMLA035B2S11</b>	—	<b>XMLA035B2C11</b>
	Corrosive fluids, up to 320 °F (160 °C)	—	—	<b>XMLA035C2C11</b>

<b>Pressure connection</b>	G 1/4-19
----------------------------	----------

<b>Electrical connection</b>	Conduit/cable entry	Pg 13.5	ISO M20	DIN 43650A, 4-pin male
	Terminals	1 x 0.2 to 2 x 2.5 mm <sup>2</sup> (1 x 24 to 2 x 14 AWG)		For suitable female connector, see page 57.

<b>Weight, lb (kg)</b>	1.53 (0.695)	1.60 (0.725)
------------------------	--------------	--------------

**Supplementary specifications (not shown under general specifications)**

<b>Inherent differential</b> (subtract from PH to get PB)	At low setting	1.25 bar ±0.25 (18.12 psi ±3.62)
	At high setting	1.25 bar ±0.25 (18.12 psi ±3.62)

<b>Maximum allowable Pressure</b>	Per cycle	45 bar (652.5 psi)
	Accidental	80 bar (1160 psi)

<b>Destruction pressure</b>	160 bar (2320 psi)
-----------------------------	--------------------

<b>Pressure switch style</b>	Diaphragm
------------------------------	-----------

**Operating curves** **Connection**

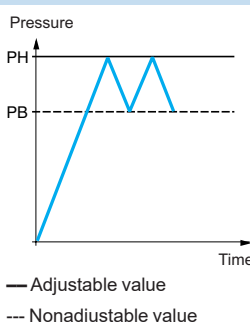
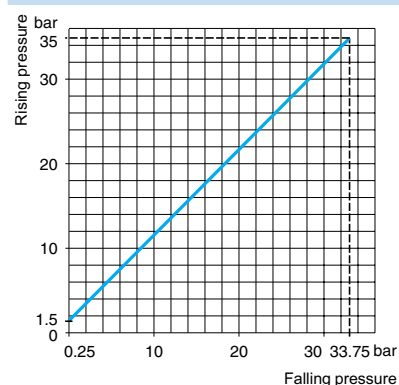

**Terminal model**



**Connector model**

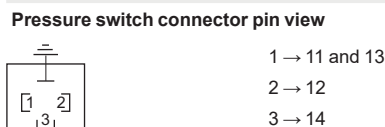

**Other versions** For switches with alternative tapped cable entries, please consult our Customer Care Center.

**Size 35 bar (507.5 psi)**  
**Adjustable differential, for regulation between two thresholds**  
**1 C/O single-pole contact**

**XMLB pressure switches** **With setting scale**

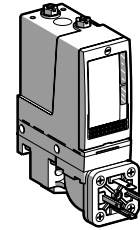
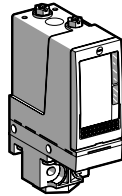

<b>Adjustable range of operating point (PH)</b> (rising pressure)	3.5–35 bar (50.75–507.5 psi)
--	------------------------------

References			
<b>Fluids controlled</b> For materials in contact with fluid, see page 62.	Hydraulic oils, fresh water, sea water, air, up to 158 °F (70 °C)	<b>XMLB035A2S11</b>	<b>XMLB035A2C11</b>
	Hydraulic oils, fresh water, sea water, air, up to 320 °F (160 °C)	<b>XMLB035B2S11</b>	–
<b>Pressure connection</b>	G 1/4-19		
<b>Electrical connection</b>	Conduit/cable entry	Pg 13.5	
	Terminals	1 x 0.2 to 2 x 2.5 mm <sup>2</sup> (1 x 24 to 2 x 14 AWG)	For suitable female connector, see page 57.
<b>Weight, lb (kg)</b>	1.58 (0.715)		1.64 (0.745)

Supplementary specifications (not shown under general specifications)		
<b>Possible differential</b> (subtract from PH to get PB)	Min. at low setting	1.7 bar, –0.5, +0.7 (24.65 psi, –7.25, +10.15)
	Min. at high setting	2.55 bar, –0.5, +0.7 (36.97 psi, –7.25, +10.15)
	Max. at high setting	20 bar (290 psi)
<b>Maximum allowable pressure</b>	Per cycle	45 bar (652.5 psi)
	Accidental	80 bar (1160 psi)
<b>Destruction pressure</b>	160 bar (2320 psi)	
<b>Pressure switch style</b>	Diaphragm	

**Operating curves** **Connection**

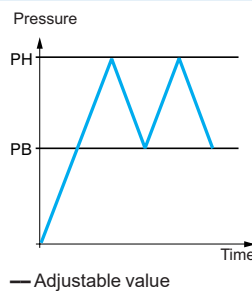
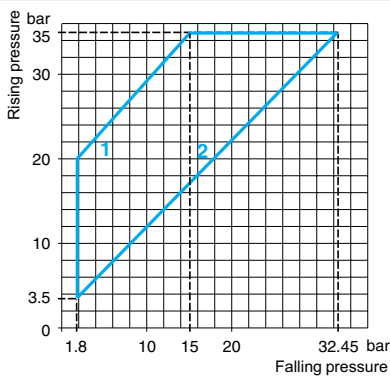

**1** Maximum differential  
**2** Minimum differential

**Terminal model**



**Connector model**

**Pressure switch connector pin view**

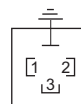

1 → 11 and 13  
2 → 12  
3 → 14

**Other versions** For switches with alternative tapped cable entries, please consult our Customer Care Center.

Size 35 bar (507.5 psi)

Adjustable differential, for regulation between two thresholds

2 C/O single-pole contacts

**XMLC pressure switches** **With setting scale**

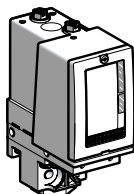

<b>Adjustable range of operating point (PH)</b> (rising pressure)	3.5-35 bar (50.75-507.5 psi)
--	------------------------------

**References**

<b>Fluids controlled</b> For materials in contact with fluid, see page 62	Hydraulic oils, fresh water, sea water, air, up to 320 °F (160 °C)	<b>XMLC035B2S12</b>
<b>Pressure connection</b>		G 1/4-19
<b>Electrical connection</b>	Conduit/cable entry	ISO M20
	Terminals	1 x 0.2 to 2 x 2.5 mm <sup>2</sup> (1 x 24 to 2 x 14 AWG)
<b>Weight, lb (kg)</b>		1.53 (0.695)

**Supplementary specifications (not shown under general specifications)**

<b>Possible differential</b> (subtract from PH to get PB)	Min. at low setting	1 bar ±0.2 (14.5 psi ±2.9)
	Min. at high setting	1.5 bar ±0.5 (21.75 psi ±7.25)
	Max. at high setting	22 bar (319 psi)
<b>Maximum allowable pressure</b>	Per cycle	45 bar (652.5 psi)
	Accidental	80 bar (1160 psi)
<b>Destruction pressure</b>		160 bar (2320 psi)
<b>Pressure switch style</b>		Diaphragm

**Operating curves** **Connection**

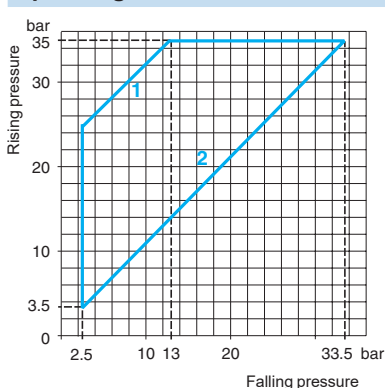

1 Maximum differential  
2 Minimum differential

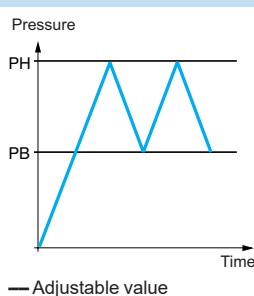

**Terminal model**

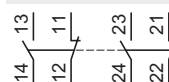

**Other versions** For switches with alternative tapped cable entries, please consult our Customer Care Center.

**Size 35 bar (507.5 psi)**  
**Dual-stage, fixed differential, for detection at each threshold**  
**2 C/O single-pole contacts (one per stage)**

**XMLD pressure switches** Without setting scale

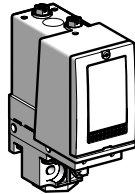

<b>Adjustable range of each operating point</b> (rising pressure)	2nd stage operating point (PH2)	4.4-35 bar (63.8-507.5 psi)
	1st stage operating point (PH1)	1.9-32.5 bar (27.55-471.25 psi)
<b>Spread between the two stages (PH2-PH1)</b>		2.5-20.4 bar (36.25-295.8 psi)

**References**

<b>Fluids controlled</b> For materials in contact with fluid, see page 62.	Corrosive fluids, up to 320 °F (160 °C)	<b>XMLD035B1S11</b>
<b>Pressure connection</b>		G 1/4-19
<b>Electrical connection</b>	Conduit/cable entry	Pg 13.5
	Terminals	1 x 0.2 to 2 x 2.5 mm <sup>2</sup> (1 x 24 to 2 x 14 AWG)
<b>Weight, lb (kg)</b>		1.58 (0.715)

**Supplementary specifications** (not shown under general specifications)

<b>Inherent differential</b> (subtract from PH1/PH2 to get PB1/PB2)	At low setting	1.5 bar ±0.3 (21.75 psi ±4.35)
	At high setting	2.6 bar, ±0.7 (37.7 psi ±10.15)
<b>Maximum allowable pressure</b>	Per cycle	45 bar (652.5 psi)
	Accidental	80 bar (1160 psi)
<b>Destruction pressure</b>		160 bar (2320 psi)
<b>Pressure switch style</b>		Diaphragm

**Operating curves**

**High setting trip points of contacts 1 and 2**

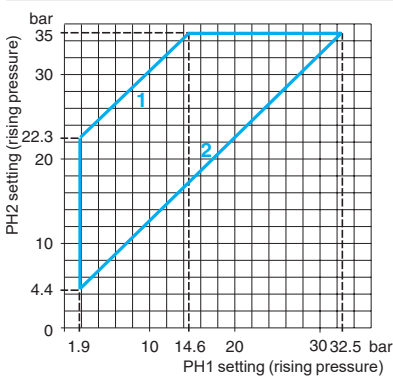

1 Maximum differential  
2 Minimum differential

**Inherent differential of contacts 1 and 2**

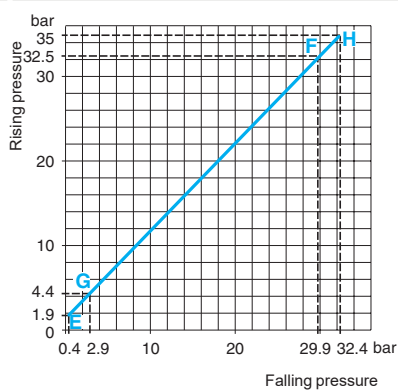

EF Contact 1 (stage 1)  
GH Contact 2 (stage 2)

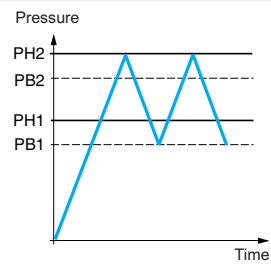

— Adjustable value  
--- Nonadjustable value

**Connection**  
**Terminal model**

Contact 2 (stage 2) Contact 1 (stage 1)

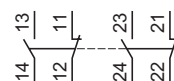

**Other versions** For switches with alternative tapped cable entries, please consult our Customer Care Center.

**Size 70 bar (1015 psi)**  
**Fixed differential, for detection of a single threshold**  
**1 C/O single-pole contact**

**XMLA pressure switches** **With setting scale**

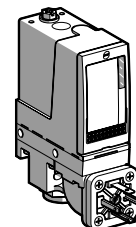
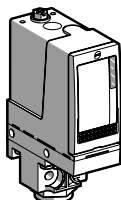

**Adjustable range of operating point (PH)**  
 (rising pressure) 5–70 bar (72.5–1015 psi)

**References**

Fluids controlled		XMLA070D2S13	XMLA070D2S11	XMLA070D2S12	XMLA070D2C11
For materials in contact with fluid, see page 62	Hydraulic oils, up to 320 °F (160 °C)				
	Fresh water, sea water, up to 320 °F (160 °C)	XMLA070E2S13	XMLA070E2S11	–	–
	Corrosive fluids, air, up to 320 °F (160 °C)	–	XMLA070N2S11	XMLA070N2S12	–

**Pressure connection** 1/4"-18 NPTF G 1/4-19

Electrical connection	Conduit/cable entry	1/2" NPT	Pg 13.5	ISO M20	DIN 43650A, 4-pin male
	Terminals	1 x 0.2 to 2 x 2.5 mm <sup>2</sup> (1 x 24 to 2 x 14 AWG)			For suitable female connector, see page 57.

**Weight, lb (kg)** 1.53 (0.695) 1.60 (0.725)

**Supplementary specifications (not shown under general specifications)**

<b>Inherent differential</b> (subtract from PH to get PB)	At low setting	3 bar ±1 (43.5 psi ±14.5)
	At high setting	7.5 bar ±1 (108.75 psi ±14.5)
<b>Maximum allowable pressure</b>	Per cycle	90 bar (1035 psi)
	Accidental	160 bar (2320 psi)
<b>Destruction pressure</b>		320 bar (4640 psi)
<b>Pressure switch style</b>		Piston

**Operating curves** **Connection**

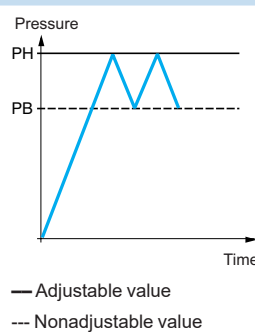
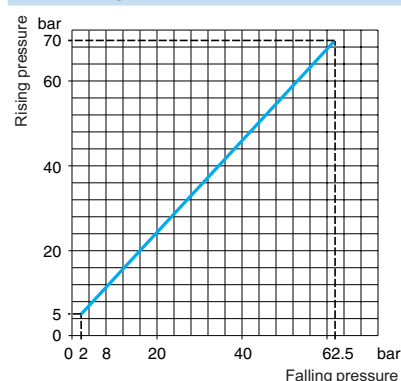

**Terminal model**



**Connector model**

**Pressure switch connector pin view**



- 1 → 11 and 13
- 2 → 12
- 3 → 14

**Other versions** For switches with alternative tapped cable entries, please consult our Customer Care Center.

**Size 70 bar (1015 psi)**  
**Adjustable differential, for regulation between two thresholds**  
**1 C/O single-pole contact**

**XMLB pressure switches** **With setting scale**

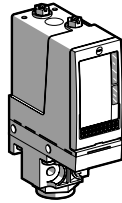

<b>Adjustable range of operating point (PH)</b> (rising pressure)	7–70 bar (101.5–1015 psi)
--	---------------------------

**References**

<b>Fluids controlled</b> For materials in contact with fluid, see page 62.	Hydraulic oils, up to 320 °F (160 °C)	<b>XMLB070D2S11</b>
	Corrosive fluids, air, up to 320 °F (160 °C)	<b>XMLB070N2S11</b>

<b>Pressure connection</b>	G 1/4-19
----------------------------	----------

<b>Electrical connection</b>	Conduit/cable entry	Pg 13.5
	Terminals	1 x 0.2 to 2 x 2.5 mm <sup>2</sup> (1 x 24 to 2 x 14 AWG)

<b>Weight, lb (kg)</b>	1.58 (0.715)
------------------------	--------------

**Supplementary specifications (not shown under general specifications)**

<b>Possible differential</b> (subtract from PH to get PB)	Min. at low setting	4.7 bar, -0.4, +0.7 (68.15 psi, -5.8, +10.15)
	Min. at high setting	8.8 bar, -0.6, +0.8 (127.6 psi, -8.7, +11.6)
	Max. at high setting	50 bar (725 psi)

<b>Maximum allowable pressure</b>	Per cycle	90 bar (1035 psi)
	Accidental	160 bar (2320 psi)

<b>Destruction pressure</b>	320 bar (4640 psi)
-----------------------------	--------------------

<b>Pressure switch style</b>	Piston
------------------------------	--------

**Operating curves** **Connection**

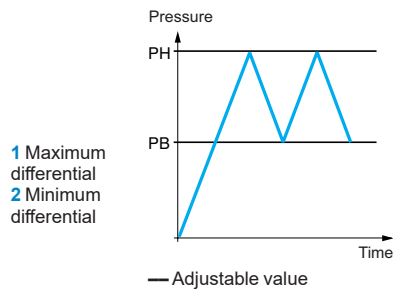
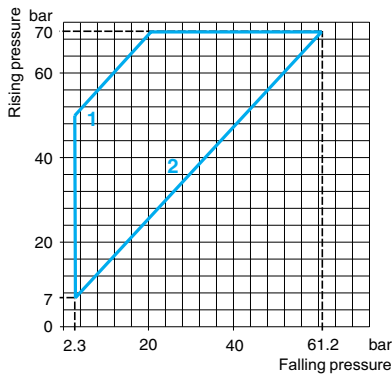

1 Maximum differential  
2 Minimum differential

**Terminal model**



**Connector model**

Pressure switch connector pin view

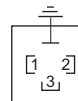

1 → 11 and 13  
2 → 12  
3 → 14

**Other versions** For switches with alternative tapped cable entries, please consult our Customer Care Center.



**Size 160 bar (2320 psi)**  
**Fixed differential, for detection of a single threshold**  
**1 C/O single-pole contact**

**XMLA pressure switches** **With setting scale**

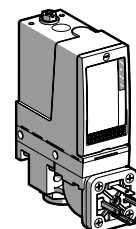
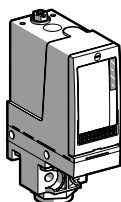

**Adjustable range of operating point (PH)**  
 (rising pressure) | 10–160 bar (145–2320 psi)

**References**

<b>Fluids controlled</b> For materials in contact with fluid, see page 62.	Hydraulic oils, up to 320 °F (160 °C)	<b>XMLA160D2S13</b>	<b>XMLA160D2S11</b>	<b>XMLA160D2S12</b>	<b>XMLA160D2C11</b>
	Fresh water, sea water, up to 320 °F (160 °C)	—	<b>XMLA160E2S11</b>	—	—
	Corrosive fluids, air, up to 320 °F (160 °C)	—	<b>XMLA160N2S11</b>	—	<b>XMLA160N2C11</b>

**Pressure connection** | 1/4"-18 NPTF | G 1/4-19

<b>Electrical connection</b>	Conduit/cable entry	1/2" NPT	Pg 13.5	ISO M20	DIN 43650A, 4-pin male.
	Terminals	1 x 0.2 to 2 x 2.5 mm <sup>2</sup> (1 x 24 to 2 x 14 AWG)			For suitable female connector, see page 57.

**Weight, lb (kg)** | 1.65 (0.750) | 1.72 (0.780)

**Supplementary specifications (not shown under general specifications)**

<b>Inherent differential</b> (subtract from PH to get PB)	At low setting	5.5 bar ±1 (79.75 psi ±14.5)
	At high setting	18 bar ±3 (261 psi ±43.5)
<b>Maximum allowable pressure</b>	Per cycle	200 bar (2900 psi)
	Accidental	360 bar (5220 psi)
<b>Destruction pressure</b>		720 bar (10,440 psi)
<b>Mechanical life</b> (depending on the application)		6 x 10 <sup>6</sup> operating cycles
<b>Pressure switch style</b>		Piston

**Operating curves** **Connection**

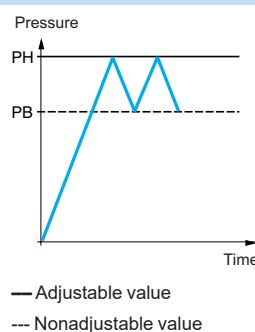
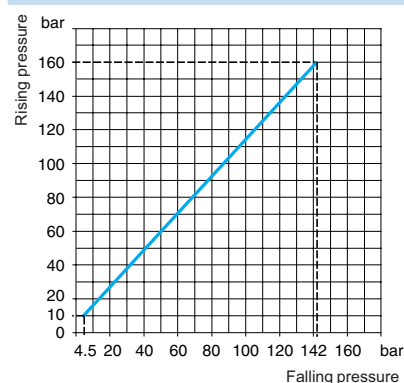

**Terminal model**



**Connector model**

**Pressure switch connector pin view**

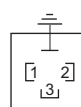

- 1 → 11 and 13
- 2 → 12
- 3 → 14

**Other versions** | For switches with alternative tapped cable entries, please consult our Customer Care Center.

**Size 160 bar (2320 psi)**  
**Adjustable differential, for regulation between two thresholds**  
**1 C/O single-pole contact**

**XMLB pressure switches** **With setting scale**

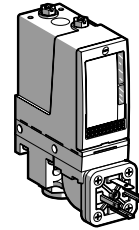
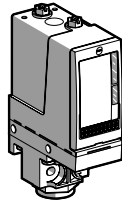

<b>Adjustable range of operating point (PH)</b> (rising pressure)	10–160 bar (145–2320 psi)
--	---------------------------

**References**

<b>Fluids controlled</b> For materials in contact with fluid, see page 62.	Hydraulic oils, up to 320 °F (160 °C)	<b>XMLB160D2S11</b>	<b>XMLB160D2S12</b>	<b>XMLB160D2C11</b>
	Corrosive fluids, air, up to 320 °F (160 °C)	<b>XMLB160N2S11</b>	–	–

<b>Pressure connection</b>	G 1/4-19			
<b>Electrical connection</b>	Conduit/cable entry	Pg 13.5	ISO M20	DIN 43650A, 4-pin male.
	Terminals	1 x 0.2 to 2 x 2.5 mm <sup>2</sup> (1 x 24 to 2 x 14 AWG)	For suitable female connector, see page 57.	
<b>Weight, lb (kg)</b>	1.65 (0.750)	1.72 (0.780)		

**Supplementary specifications (not shown under general specifications)**

<b>Possible differential</b> (subtract from PH to get PB)	Min. at low setting	9.3 bar, –1.8, +1.5 (134.85 psi, –26.1, +21.75)
	Min. at high setting	20.8 bar, –1.9, +1.6 (301.6 psi, –27.55, +23.2)
	Max. at high setting	100 bar (1450 psi)
<b>Maximum allowable pressure</b>	Per cycle	200 bar (2900 psi)
	Accidental	360 bar (5220 psi)
<b>Destruction pressure</b>	720 bar (10,440 psi)	
<b>Pressure switch style</b>	Piston	

**Operating curves** **Connection**

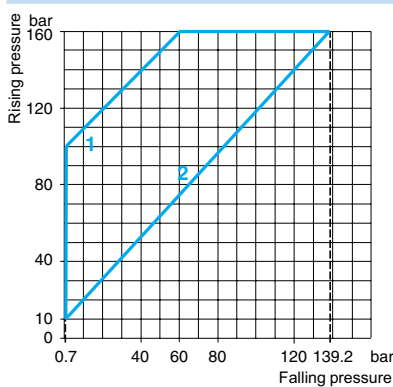

**1** Maximum differential  
**2** Minimum differential

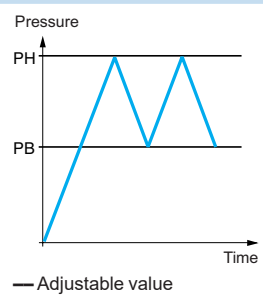

**Terminal model**



**Connector model**

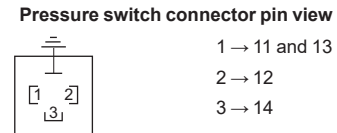

**Other versions** For switches with alternative tapped cable entries, please consult our Customer Care Center.

**Size 160 bar (2320 psi)**  
**Adjustable differential, for regulation between two thresholds**  
**2 C/O single-pole contacts**

**XMLC pressure switches** **With setting scale**

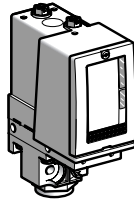

**Adjustable range of operating point (PH)**  
(rising pressure) | 12–160 bar (174–2320 psi)

**References**

<b>Fluids controlled</b> Hydraulic oils, up to 320 °F (160 °C) For materials in contact with fluid, see page 62	<b>XMLC160D2S11</b>	<b>XMLC160D2S12</b>
<b>Pressure connection</b>	G 1/4-19	
<b>Electrical connection</b>	Conduit/cable entry	Pg 13.5
	Terminals	ISO M20
<b>Weight, lb (kg)</b>	1.65 (0.750)	

**Supplementary specifications (not shown under general specifications)**

<b>Possible differential</b> (subtract from PH to get PB)	Min. at low setting	9 bar ±0.9 (130.5 psi ±13.05)
	Min. at high setting	21 bar ±0.9 (304.5 psi ±13.05)
	Max. at high setting	110 bar (1590 psi)
<b>Maximum allowable pressure</b>	Per cycle	200 bar (2900 psi)
	Accidental	360 bar (5220 psi)
<b>Destruction pressure</b>	720 bar (10,440 psi)	
<b>Mechanical life</b> (depending on the application)	6 x 10 <sup>6</sup> operating cycles	
<b>Pressure switch style</b>	Piston	

**Operating curves** **Connection**

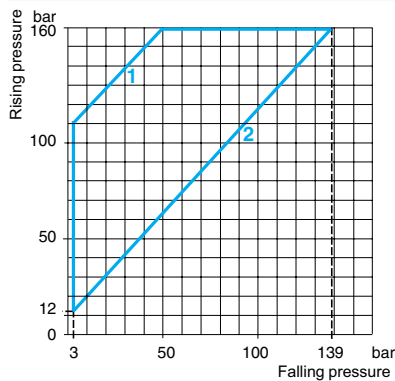

**1** Maximum differential  
**2** Minimum differential

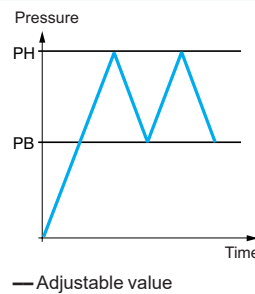

**Terminal model**

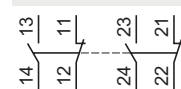

**Other versions** For switches with alternative tapped cable entries, please consult our Customer Care Center.

**Size 160 bar (2320 psi)**  
**Dual-stage, fixed differential, for detection at each threshold**  
**2 C/O single-pole contacts (one per stage)**

**XMLD pressure switches** Without setting scale

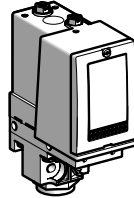

<b>Adjustable range of each operating point (rising pressure)</b>	2nd stage operating point (PH2)	16.5–160 bar (239.25–2320 psi)
	1st stage operating point (PH1)	10.5–154 bar (152.25–2233 psi)
<b>Spread between the two stages (PH2–PH1)</b>		6–83 bar (87–1203.5 psi)

**References**

<b>Fluids controlled</b> Hydraulic oils, up to 320 °F (160 °C) For materials in contact with fluid, see page 62.	<b>XMLD160D1S13</b>	
<b>Pressure connection</b>	1/4"-18 NPTF	
<b>Electrical connection</b>	Conduit/cable entry	1/2" NPT
	Terminals	1 x 0.2 to 2 x 2.5 mm <sup>2</sup> (1 x 24 to 2 x 14 AWG)
<b>Weight, lb (kg)</b>	1.65 (0.750)	

**Supplementary specifications (not shown under general specifications)**

<b>Inherent differential</b> (subtract from PH1/PH2 to get PB1/PB2)	At low setting	8.8 bar ±1.5 (127.6 psi ±21.75)
	At high setting	20 bar ±7 (290 psi ±101.5)
<b>Maximum allowable pressure</b>	Per cycle	200 bar (2900 psi)
	Accidental	360 bar (5220 psi)
<b>Destruction pressure</b>		720 bar (10,440 psi)
<b>Pressure switch style</b>		Piston

**Operating curves**

**High setting trip points of contacts 1 and 2**

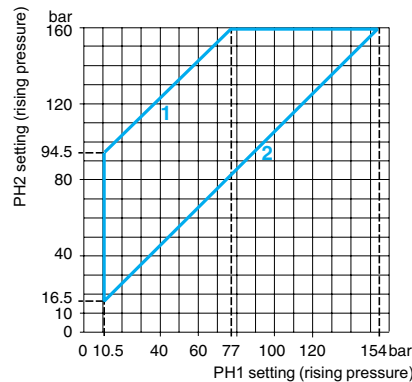

- 1 Maximum differential
- 2 Minimum differential

**Inherent differential of contacts 1 and 2**

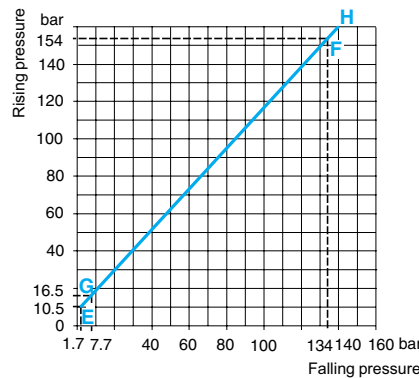

- EF Contact 1 (stage 1)
- GH Contact 2 (stage 2)

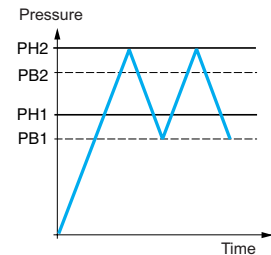

- Adjustable value
- Nonadjustable value

**Connection**

**Terminal model**

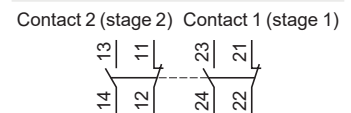

**Other versions** For switches with alternative tapped cable entries, please consult our Customer Care Center.

**Size 300 bar (4350 psi)**  
**Fixed differential, for detection of a single threshold**  
**1 C/O single-pole contact**

**XMLA pressure switches** **With setting scale**

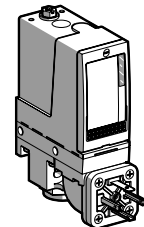
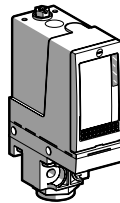

<b>Adjustable range of operating point (PH)</b> (rising pressure)	20–300 bar (290–4350 psi)				
<b>Electrical connection</b>	Terminals		DIN connector		
<b>References</b>					
<b>Fluids controlled</b> For materials in contact with fluid, see page 62. Only for control of group 2 fluids, in accordance with directive 97/23/EEC.	Hydraulic oils, up to 320 °F (160 °C)	<b>XMLA300D2S13</b>	<b>XMLA300D2S11</b>	<b>XMLA300D2S12</b>	<b>XMLA300D2C11</b>
	Fresh water, sea water, up to 320 °F (160 °C)	—	<b>XMLA300E2S11</b>	<b>XMLA300E2S12</b>	—
	Corrosive fluids, air, up to 320 °F (160 °C)	—	<b>XMLA300N2S11</b>	—	—
<b>Pressure connection</b>		1/4"-18 NPTF	G 1/4-19		
<b>Electrical connection</b>	Conduit/cable entry	1/2" NPT	Pg 13.5	ISO M20	DIN 43650A, 4-pin male
	Terminals	1 x 0.2 to 2 x 2.5 mm <sup>2</sup> (1 x 24 to 2 x 14 AWG)			For suitable female connector, see page 57.
<b>Weight, lb (kg)</b>	1.65 (0.750)			1.72 (0.780)	

**Supplementary specifications (not shown under general specifications)**

<b>Inherent differential</b> (subtract from PH to get PB)	At low setting	16.5 bar ±3 (239.25 psi ±43.5)
	At high setting	35 bar ±6 (507.5 psi ±87)
<b>Maximum allowable pressure</b>	Per cycle	375 bar (5437.5 psi)
	Accidental	675 bar (9787.5 psi)
<b>Destruction pressure</b>		1350 bar (19,575 psi)
<b>Pressure switch style</b>		Piston

**Operating curves** **Connection**

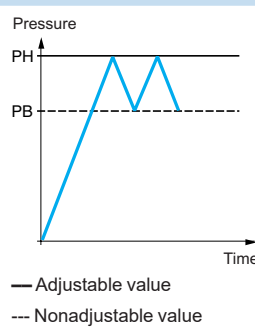
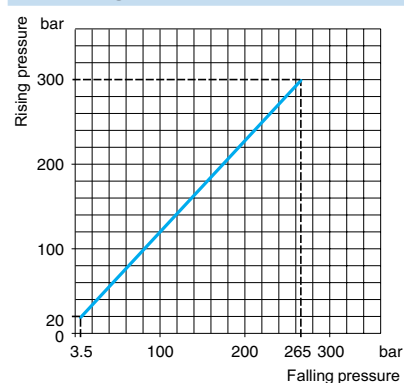

**Terminal model**

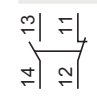

**Connector model**

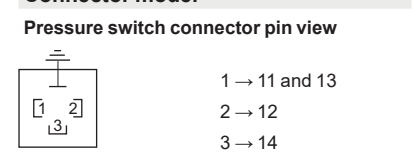

**Other versions** For switches with alternative tapped cable entries, please consult our Customer Care Center.

**Size 300 bar (4350 psi)**  
**Adjustable differential, for regulation between two thresholds**  
**1 C/O single-pole contact**

**XMLB pressure switches** **With setting scale**

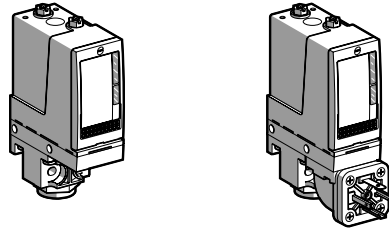

**Adjustable range of operating point (PH)**  
(rising pressure) 22–300 bar (319–4350 psi)

**References**

<b>Fluids controlled</b> For materials in contact with fluid, see page 62. Only for control of group 2 fluids, in accordance with directive 97/23/EEC.	Hydraulic oils, up to 320 °F (160 °C)	<b>XMLB300D2S11</b>	<b>XMLB300D2S12</b>	<b>XMLB300D2C11</b>
	Corrosive fluids, air, up to 320 °F (160 °C)	–	<b>XMLB300N2S12</b>	–

**Pressure connection** G 1/4-19

<b>Electrical connection</b>	Conduit/cable entry	Pg 13.5	ISO M20	DIN 43650A, 4-pin male.
	Terminals	1 x 0.2 to 2 x 2.5 mm <sup>2</sup> (1 x 24 to 2 x 14 AWG)		For suitable female connector, see page 57.

**Weight, lb (kg)** 1.65 (0.750) 1.72 (0.780)

**Supplementary specifications (not shown under general specifications)**

<b>Possible differential</b> (subtract from PH to get PB)	Min. at low setting	19.4 bar –1.5, +1.7 (281.3 psi, –21.75, +24.65)
	Min. at high setting	37 bar, –1, +4 (536.5 psi, –14.5, +58)
	Max. at high setting	200 bar (2900 psi)
<b>Maximum allowable pressure</b>	Per cycle	375 bar (5437.5 psi)
	Accidental	675 bar (9787.5 psi)
<b>Destruction pressure</b>		1350 bar (19,575 psi)
<b>Pressure switch style</b>		Piston

**Operating curves** **Connection**

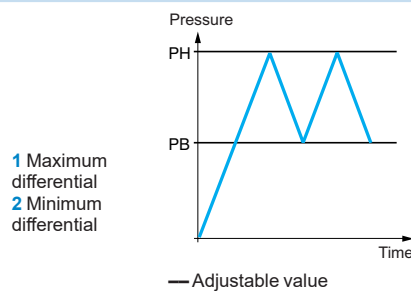
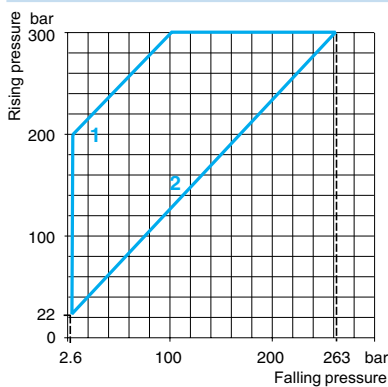

**1** Maximum differential  
**2** Minimum differential

**Terminal model**

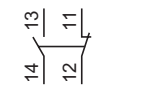

**Connector model**

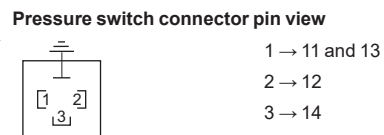

**Other versions** For switches with alternative tapped cable entries, please consult our Customer Care Center.

Size 300 bar (4350 psi)

Adjustable differential, for regulation between two thresholds

2 C/O single-pole contacts

**XMLC pressure switches** **With setting scale**

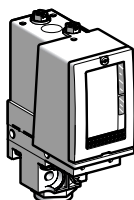

**Adjustable range of operating point (PH)**  
(rising pressure) 22–300 bar (319–4350 psi)

**References**

<b>Fluids controlled</b> Hydraulic oils, up to 320 °F (160 °C) For materials in contact with fluid, see page 62. Only for control of group 2 fluids, in accordance with directive 97/23/EEC.	<b>XMLC300D2S13</b>	<b>XMLC300D2S11</b>	<b>XMLC300D2S12</b>

**Pressure connection** 1/4"-18 NPTF G 1/4-19

**Electrical connection** Conduit/cable entry 1/2" NPT Pg 13.5 ISO M20  
Terminals 1 x 0.2 to 2 x 2.5 mm<sup>2</sup> (1 x 24 to 2 x 14 AWG)

**Weight, lb (kg)** 1.65 (0.750)

**Supplementary specifications (not shown under general specifications)**

<b>Possible differential</b> (subtract from PH to get PB)	Min. at low setting	16 bar ±0.9 (232 psi ±13.05)
	Min. at high setting	35 bar ±0.9 (507.5 psi ±13.05)
	Max. at high setting	240 bar (3480 psi)
<b>Maximum allowable pressure</b>	Per cycle	375 bar (5437.5 psi)
	Accidental	675 bar (9787.5 psi)
<b>Destruction pressure</b>		1350 bar (19,575 psi)
<b>Mechanical life</b> (depending on the application)		3 x 10 <sup>6</sup> operating cycles
<b>Pressure switch style</b>		Piston

**Operating curves** **Connection**

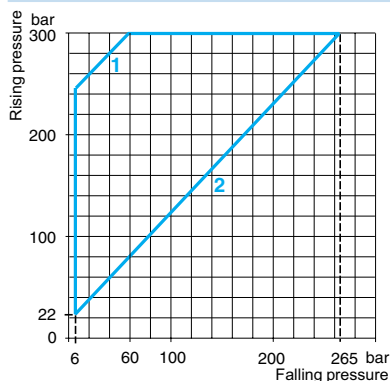

1 Maximum differential  
2 Minimum differential

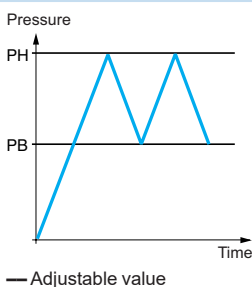

**Terminal model**

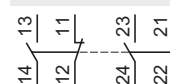

**Other versions**

For switches with alternative tapped cable entries, please consult our Customer Care Center.

**Size 500 bar (7250 psi)**  
**Fixed differential, for detection of a single threshold**  
**1 C/O single-pole contact**

**XMLA pressure switches**      **With setting scale**      **Without setting scale**

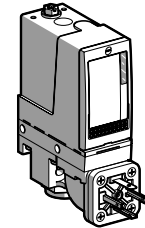
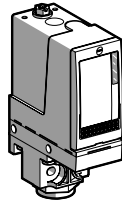

**Adjustable range of operating point (PH)**  
(rising pressure)      30–500 bar (435–7250 psi)

**References**

<b>Fluids controlled</b> For materials in contact with fluid, see page 62. Only for control of group 2 fluids, in accordance with directive 97/23/EEC.	Hydraulic oils, up to 320 °F (160 °C)	<b>XMLA500D2S13</b>	<b>XMLA500D2S11</b>	<b>XMLA500D2S12</b>	–
	Corrosive fluids, air, up to 320 °F (160 °C)	–	<b>XMLA500N2S11</b>	–	<b>XMLA500N2C11</b>

**Pressure connection**      1/4"-18 NPTF      G 1/4-19

**Electrical connection**      Conduit/cable entry      1/2" NPT      Pg 13.5      ISO M20      DIN 43650A, 4-pin male

Terminals      1 x 0.2 to 2 x 2.5 mm<sup>2</sup> (1 x 24 to 2 x 14 AWG)      For suitable female connector, see page 57.

**Weight, lb (kg)**      1.65 (0.750)      1.72 (0.780)

**Supplementary specifications (not shown under general specifications)**

<b>Inherent differential</b> (subtract from PH to get PB)	At low setting	20 bar ±6 (290 psi ±87)
	At high setting	45 bar ±10 (652.5 psi ±145)
<b>Maximum allowable pressure</b>	Per cycle	625 bar (9062.5 psi)
	Accidental	1125 bar (16,312.5 psi)
<b>Destruction pressure</b>		2250 bar (32,625 psi)
<b>Mechanical life (depending on the application)</b>		3 x 10 <sup>6</sup> operating cycles
<b>Pressure switch style</b>		Piston

**Operating curves**      **Connection**

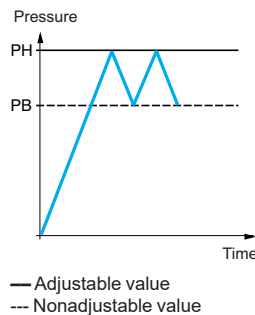
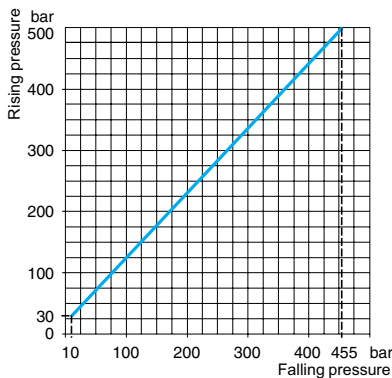

**Terminal model**



**Connector model**

**Pressure switch connector pin view**

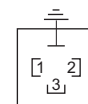

1 → 11 and 13  
2 → 12  
3 → 14

**Other versions**      For switches with alternative tapped cable entries, please consult our Customer Care Center.



**Size 500 bar (7250 psi)**  
**Adjustable differential, for regulation between two thresholds**  
**1 C/O single-pole contact**

**XMLB pressure switches** **With setting scale**

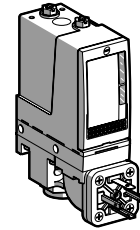
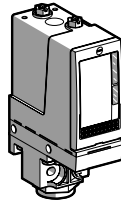

**Adjustable range of operating point (PH)**  
(rising pressure) 30–500 bar (435–7250 psi)

**References**

<b>Fluids controlled</b> For materials in contact with fluid, see page 62. Only for control of group 2 fluids, in accordance with directive 97/23/EEC.	Hydraulic oils, up to 320 °F (160 °C)	<b>XMLB500D2S11</b>	<b>XMLB500D2S12</b>	<b>XMLB500D2C11</b>
	Corrosive fluids, air, up to 320 °F (160 °C)	<b>XMLB500N2S11</b>	<b>XMLB500N2S12</b>	<b>XMLB500N2C11</b>

**Pressure connection** G 1/4-19

<b>Electrical connection</b>	Conduit/cable entry	Pg 13.5	ISO M20	DIN 43650A, 4-pin male
	Terminals	1 x 0.2 to 2 x 2.5 mm <sup>2</sup> (1 x 24 to 2 x 14 AWG)		For suitable female connector, see page 57.

**Weight, lb (kg)** 1.65 (0.750) 1.72 (0.780)

**Supplementary specifications (not shown under general specifications)**

<b>Possible differential</b> (subtract from PH to get PB)	Min. at low setting	23 bar, -2.6, +3.8 (333.5 psi, -37.7, +55.1)
	Min. at high setting	52.6 bar, -14.8, +11.2 (762.7 psi, -214.6, +162.4)
	Max. at high setting	300 bar (4350 psi)
<b>Maximum allowable pressure</b>	Per cycle	625 bar (9062.5 psi)
	Accidental	1125 bar (16,312.5 psi)
<b>Destruction pressure</b>		2250 bar (32,625 psi)
<b>Pressure switch style</b>		Piston

**Operating curves** **Connection**

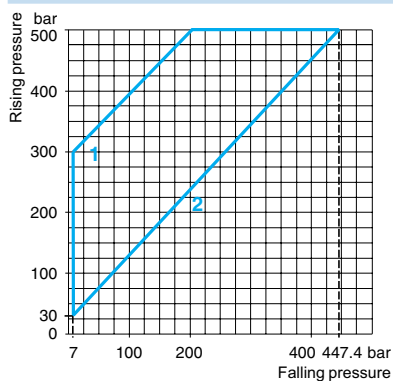

1 Maximum differential  
2 Minimum differential

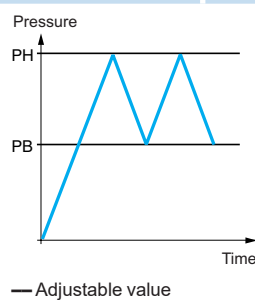

**Terminal model**



**Connector model**

**Pressure switch connector pin view**

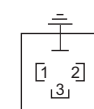

1 → 11 and 13  
2 → 12  
3 → 14

**Other versions** For switches with alternative tapped cable entries, please consult our Customer Care Center.

**Size 500 bar (7250 psi)**  
**Dual-stage, fixed differential, for detection at each threshold**  
**2 C/O single-pole contacts (one per stage)**

**XMLD pressure switches** Without setting scale

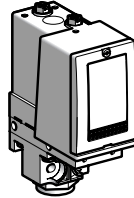

<b>Adjustable range of each operating point (rising pressure)</b>	2nd stage operating point (PH2)	41–500 bar (594.5–7250 psi)
	1st stage operating point (PH1)	25–484 bar (362.5–7018 psi)
<b>Spread between the two stages (PH2–PH1)</b>		16–244 bar (232–3538 psi)

**References**

<b>Fluids controlled</b> For materials in contact with fluid, see page 62. Only for control of group 2 fluids, in accordance with directive 97/23/EEC.	Hydraulic oils, up to 320 °F (160 °C)	<b>XMLD500D1S11</b>
<b>Pressure connection</b>		G 1/4-19
<b>Electrical connection</b>	Conduit/cable entry	Pg 13.5 conduit/cable entry
	Terminals	1 x 0.2 to 2 x 2.5 mm <sup>2</sup> (1 x 24 to 2 x 14 AWG)
<b>Weight, lb (kg)</b>		1.65 (0.750)

**Supplementary specifications (not shown under general specifications)**

<b>Inherent differential</b> (subtract from PH1/PH2 to get PB1/PB2)	At low setting	21 bar ±3 (304.5 psi ±43.5)
	At high setting	65 bar ±10 (942.5 psi ±145)
<b>Maximum allowable pressure</b>	Per cycle	625 bar (9,062.5 psi)
	Accidental	1125 bar (16,312.5 psi)
<b>Destruction pressure</b>		2250 bar (32,625 psi)
<b>Pressure switch style</b>		Piston

**Operating curves**

**High setting trip points of contacts 1 and 2**

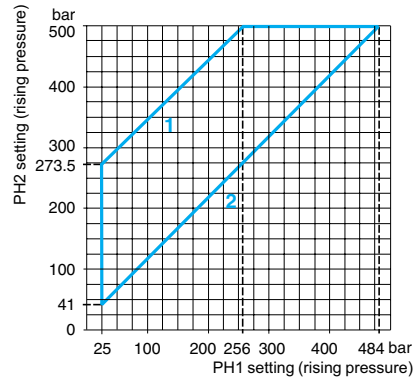

- 1 Maximum differential
- 2 Minimum differential

**Inherent differential of contacts 1 and 2**

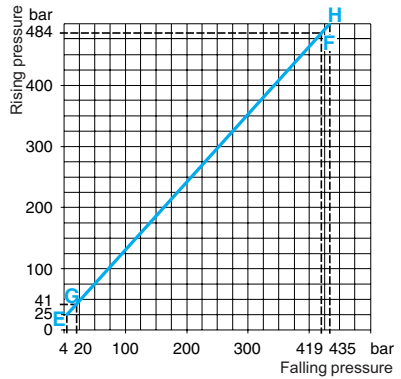

- EF Contact 1 (stage 1)
- GH Contact 2 (stage 2)

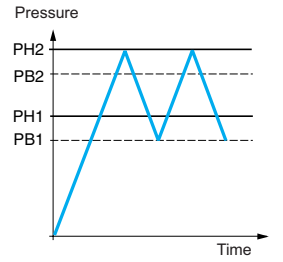

— Adjustable value  
--- Nonadjustable value

**Connection**

**Terminal model**

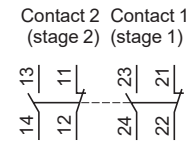

**Other versions**

For switches with alternative tapped cable entries, please consult our Customer Care Center.

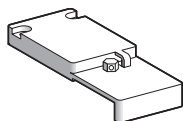

XMLZL001

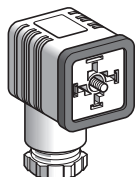

XZCC43FCP40B

### Accessories for pressure switches and vacuum switches

Description	Specific characteristics	For use with switches	Reference	Weight lb (kg)
Lead sealable protective cover to prevent unauthorized access to adjustment screws and fixing screw of switch cover	–	XMLA XMLB	XMLZL001	0.08 (0.035)
Female connector, DIN 43650A	–	XML●●●●●●C11	XZCC43FCP40B	0.08 (0.035)
Jumper cable, DIN 43650A - M12, straight male, for splitter boxes	1 m	XML●●●●●●C11	XZCR1523062K1	0.18 (0.080)

### Renewal parts

Description	Specific characteristics	For use with switches	Catalog number	Weight lb (kg)
Diaphragms	–	XML●S35	XMLZL013	0.13 (0.060)
	–	XML●S02	XMLZL014	0.09 (0.040)

### Connection

Connector pinout

XZCC43FCP40B

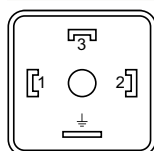

Jumper cable, DIN 43650A, M12 straight male

XZCR1523062K1

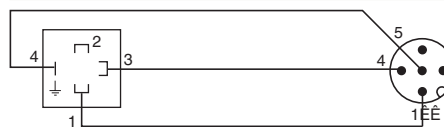

### Cable connections

XZCPV, XZCP

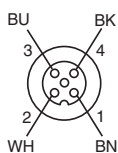

XZCC43F

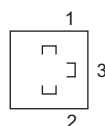

XZCC12F



# Electromechanical pressure and vacuum switches

## XML range

**XML•L35, XML•001, XML•S**

mm  
in.

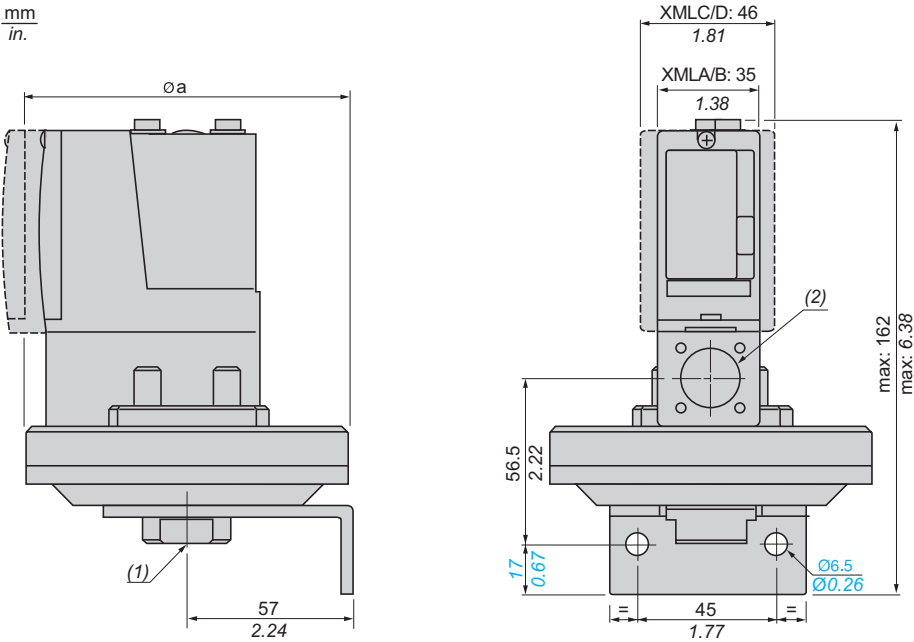

- (1) 1 fluid entry, tapped G 1/4 (BSP female).
- (2) 1 electrical connection entry, tapped M20 x 1.5, Pg 13.5, or 1/4"-18 NTP.

**XMLBM03, XMLBL05**

mm  
in.

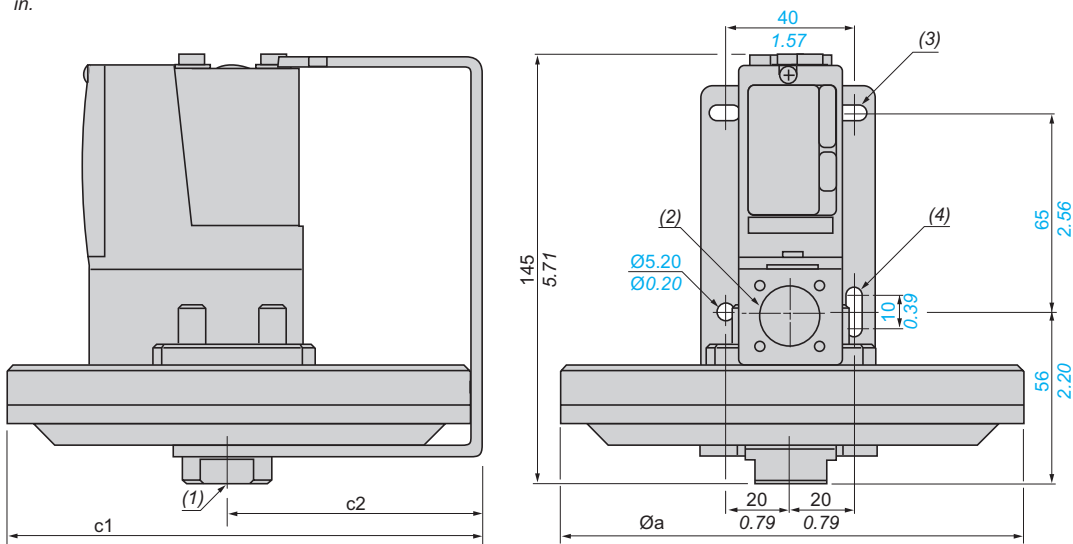

XML	$\varnothing a$	c1	c2
BM03	150 (5.91)	155.5 (6.12)	80.5 (3.17)
BL05	200 (7.87)	204 (8.03)	104 (4.09)
•L35, •001	110 (4.33)	-	-
•S35, •S02, •S04	110 (4.33)	-	-
•S10, •S20	86 (3.39)	-	-

- (1) 1 fluid entry, tapped G 1/4 (BSP female)
- (2) 1 electrical connection entry, tapped M20 x 1.5, Pg 13.5, or 1/2" NTP
- (3) 2 elongated holes  $\varnothing 10.2 \times 5.2$  (0.40 x 0.20)
- (4) 1 elongated hole  $\varnothing 15.2 \times 5.2$  (0.60 x 0.20)

**XMLAM01, XMLBM05, XMLCM05, XMLA004, XML●010 to 500**

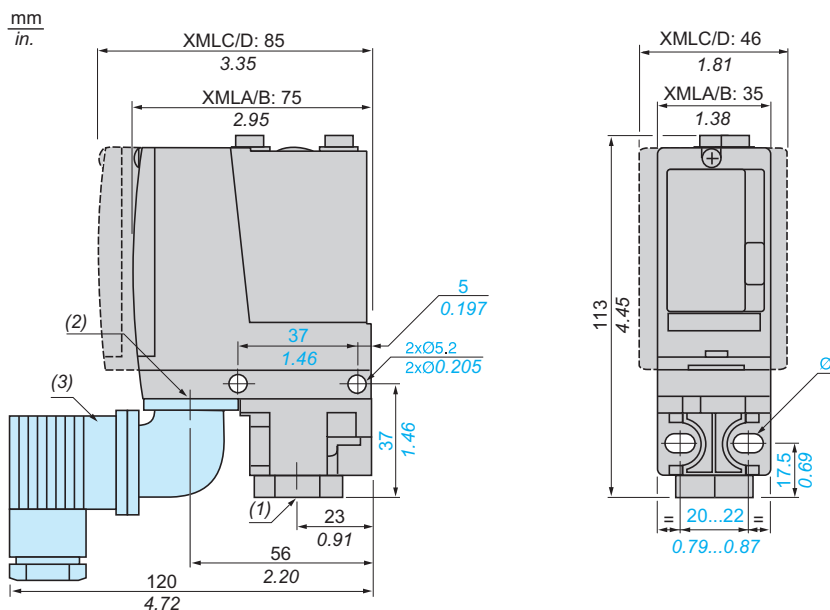

- (1) 1 fluid entry, tapped G 1/4 (BSP female).
  - (2) 1 electrical connection entry, tapped M20 x 1.5, Pg 13.5, or 1/4"-18 NTP.
  - (3) DIN connector.
- Ø: 2 elongated holes, Ø5.2 x 6.7

**XML●M02, XML●002, XMLB004, XMLC004, XMLD004**

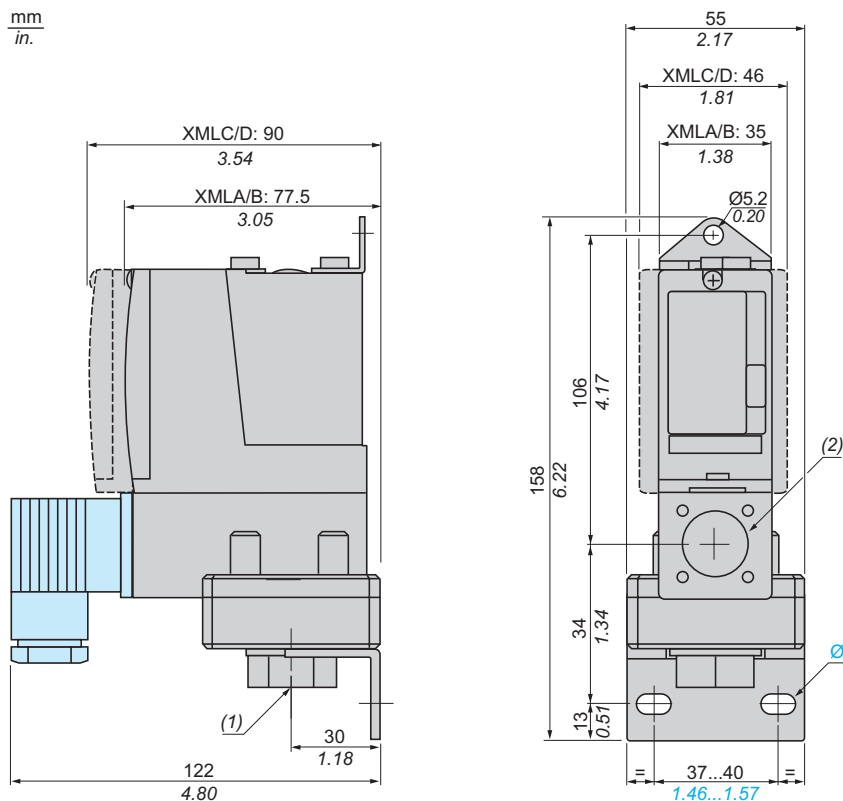

- (1) 1 fluid entry, tapped G 1/4 (BSP female).
  - (2) 1 electrical connection entry, tapped M20 x 1.5, Pg 13.5, or 1/4"-18 NTP.
- Ø: 2 elongated holes, Ø10.2 x 5.2

**XMLBL35P, XMLB001P (for viscous products)**

mm  
in.

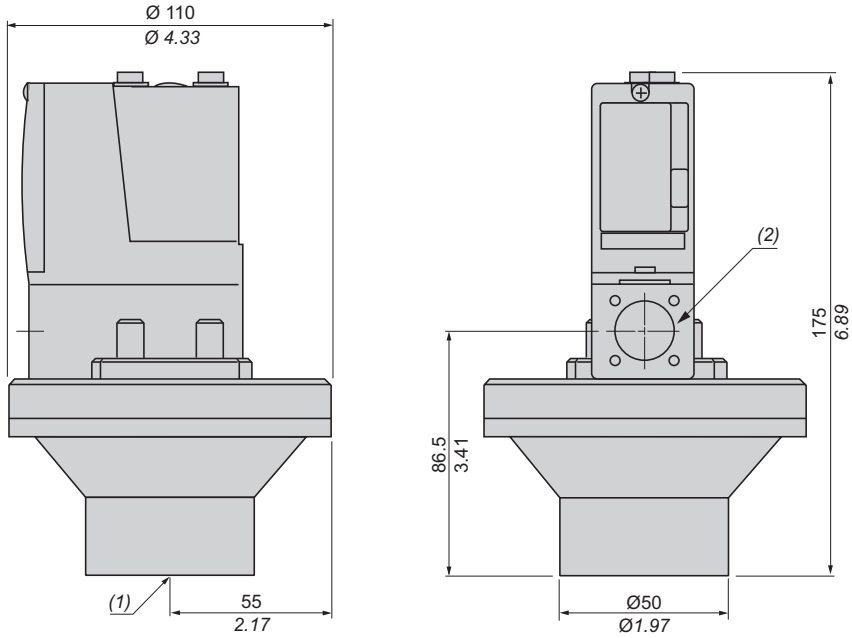

(1) 1 fluid entry, tapped G 1-1/4 (BSP female)

(2) 1 electrical connection entry, tapped M20 x 1.5 or Pg 13.5.

XMLBM05P, XMLA004P, XML●010P, XML●020P, XML●035P (for viscous products)

mm  
in.

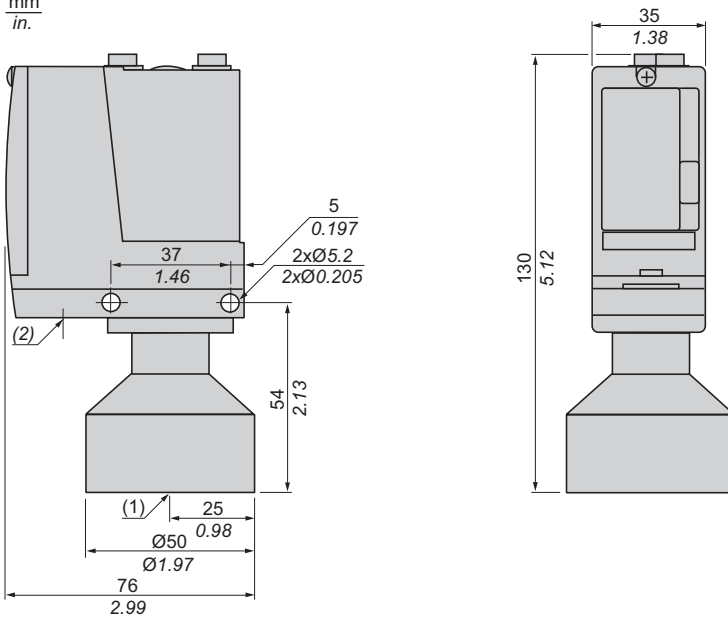

(1) 1 fluid entry, tapped G 1-1/4 (BSP female)

(2) 1 electrical connection entry, tapped M20 x 1.5 or Pg 13.5.

Component Materials in Contact with Fluid								
Pressure or vacuum switch catalog number	Zinc alloy	Stainless steel	Brass	Steel	Nitrile	PTFE	FPM, FKM	Aluminium
XMLAM01V●●●●, XML●M02V●●●●		(1)						
XMLAM01T●●●●, XML●M02T●●●●		(2)						
XMLBM03R●●●●								
XMLBM03S●●●●		(3)						
XML●M05A●●●●		(1)						
XML●M05B●●●●		(1)						
XML●M05C●●●●		(1)						
XMLBM05●●●●		(1)						
XMLBL05R●●●●								
XMLBL05S●●●●		(3)						
XML●L35R●●●●, XML●S35R●●●●		(1)						
XML●L35S●●●●		(3)						
XMLBL35P●●●●		(1)						
XML●001R●●●●		(1)						
XML●001S●●●●		(3)						
XMLB001P●●●●		(1)						
XML●002A●●●●								
XML●002B●●●●, XML●S02B●●●●								
XML●002C●●●●		(3)						
XMLA004A●●●●								
XMLA004B●●●●								
XMLA004C●●●●		(2)						
XMLA004P●●●●								

(1) 1.4307 (AISI 316L)  
 (2) 1.4404 (AISI 316L)  
 (3) 1.4305 (AISI 303)

 Materials in contact with fluid



Component Materials in Contact with Fluid (continued)								
Pressure switch catalog number	Zinc alloy	Stainless steel	Brass	Steel	Nitrile	PTFE	FPM, FKM	Aluminium
XMLB004A●●●●								
XML●004B●●●●, XML●S04B●●●●								
XML●004C●●●●		(3)						
XML●010A●●●●								
XML●010B●●●●								
XML●010C●●●●		(2)						
XML●010P●●●●, XML●S10A●●●●								
XML●020A●●●●, XML●035A●●●●								
XML●020B●●●●, XML●035B●●●●								
XML●020C●●●●, XML●035C●●●●		(2)						
XML●020P●●●●, XML●035P●●●●, XML●S20A●●●●								
XML●070D●●●●, XML●160D●●●●								
XML●070E●●●●, XML●160E●●●●		(4)						
XML●070N●●●●, XML●160N●●●●		(5)						
XML●300D●●●●								
XML●300E●●●●		(4)						
XML●300N●●●●		(5)						
XML●500D●●●●								
XML●500E●●●●								
XML●500N●●●●4		(5)						

Grade of Stainless Steel

- (1) 1.4307 (AISI 316L)
- (2) 1.4404 (AISI 316L)
- (3) 1.4305 (AISI 303)
- (4) 1.4404 (AISI 316L) + 1.4462
- (5) 1.4404 (AISI 316L) + 1.4305 (AISI 303)

 Materials in contact with fluid

# 9012G and 9016G industrial pressure and vacuum switches

## 9012G pressure switches

The 9012G pressure switches are UL Listed and CSA certified as industrial control equipment. They are used to interface pneumatic or hydraulic systems with electrical control systems by opening or closing electrical contacts in response to pressure changes in the system. They have outstanding repeatability and drift performance. Their efficient design uses durable, low mass components for excellent performance under heavy duty vibration and shock conditions.

The 9012G pressure switches line offers devices with either diaphragm or piston actuators—for optimum life, versatility, and speed of operation. Features include the following:

- High shock resistance
- High set-point stability
- Internal or external range adjustment
- No drain line required
- Dual numerical range scale (psi and kPa)
- One or two SPDT double-break contacts
- Adjustable or fixed (nonadjustable) differential
- Single-stage, dual-stage, or differential-pressure operation

A variety of modifications is available (see also page 69):

**The 9012G diaphragm switches** range from 0.2-675 psi falling pressure. Nitrile diaphragms and zinc-plated steel flanges are standard. Diaphragms of Viton® fluorocarbon or ethylene propylene are available as well as stainless steel flanges.

**The 9012G piston-actuated switches** range from 20-9,000 psi falling pressure. They have sealed pistons and can be used on air, water, oil, or any media compatible with the actuator material. The switches come standard with stainless steel pistons and housings, Viton diaphragms and O-ring seals, and Teflon® retaining rings. Ethylene propylene diaphragms and O-ring seals are also available.

**The 9012G industrial pressure switches** are available as open type or in NEMA 1 enclosures. The backplate is steel with a plastic cover. Open devices in pressure ranges up to 250 psi are available with internal- or external-threaded pressure connectors, ideally suiting them for panel mounting.

**The 9012G machine tool pressure switches** with NEMA 4, 4X, or 13 (IP66) cast aluminum enclosures are UL Listed and CSA certified as industrial control equipment. They are also UL Marine Listed for use on vessels greater than 65 ft long where ignition protection is not required.

The 9012G machine tool switches are also available in NEMA 7 & 9 cast aluminum enclosures. These are UL Listed for use in Class I, Divisions 1 and 2, Groups C and D, and Class II, Divisions 1 and 2, Groups E, F, G hazardous locations.

### Application and general information

9012 pressure switches can generally be used in any application where electrical contacts must open or close in response to a system pressure change, within the electrical and pressure ratings of the switch. Pressure switches are used in a wide variety of applications such as the following:

- compressed air systems
- HVAC equipment
- chillers
- pumping systems
- machine tools
- stamping presses
- automatic grinders
- welders
- process equipment
- molding machines

Pressure switches typically perform one of the following two functions:

Monitoring the pressure in the system. The switch can be used either as an interlock that sequences operations in an automatic system, or to give an audio or visual signal, typically an alarm of an undesired condition, at predetermined pressures.

A switch with a **fixed** differential is generally used in these applications.

Controlling the pressure in the system by starting and stopping a pump or a compressor at predetermined pressures. A switch with an **adjustable** differential is usually needed in these applications.

# 9012G and 9016G industrial pressure and vacuum switches

## 9012G pressure switches

### Diaphragm life

The elastomer diaphragms used on 9012G switches can withstand high speed cycling and wide pressure changes. They can tolerate operating speeds up to 200 cycles per minute with no negative impact on the life of the diaphragm.

Diaphragm life is affected by pressure medium compatibility. Standard diaphragms on 9012G devices are nitrile in zinc-plated steel flanges. Also available are Viton fluorocarbon and ethylene propylene diaphragms, as well as Type 316 stainless steel flanges.

The diaphragm can withstand wide pressure changes on each operating cycle. However, the pressure applied to the diaphragm during the normal operating cycle should never exceed the maximum value listed in the Range column in the catalog listing. Regularly cycling the pressure above this value reduces life considerably. If significant surges are common, or if pressures are higher than those listed in the Range column, consider using a piston device.

### Piston life

For long piston life, the pressure medium should be filtered to keep foreign matter such as dirt and chips out of the piston assembly. 9012G sealed piston devices are not recommended for use on dry gas media, since this usage could cause some leakage past the seal. Depending on the gas, the media pressure, and the rate of operation, the amount of leakage could render the switch inoperable. (Note, however, that some weepage of the media is necessary to lubricate the seals. This small amount of weepage does not indicate a problem.)

### Surges

One of the most destructive conditions for a pressure switch is hydraulic surge. A surge is a high rate of rise in pressure, normally of short duration, caused by starting a pump or by opening and closing a valve. Extremely high rates of rise in pressure can be damaging even if they are within the limits of the maximum allowable pressure.

To limit the effect of surges, the switch should be mounted as close to an accumulator and as far from the pump or quick acting valve as possible. The 9012G piston-actuated switches have a 0.020 in. pressure orifice to help reduce the effects of minor surges. 9012G diaphragm-actuated switches have a 0.060 in. pressure orifice. A restrictor with a small orifice placed in the line between the switch and the pump or valve will further help to protect the switch.

### Vibration

Among other things, excessive vibration can cause contact bounce, chatter, or premature contact transfer, especially when system pressure is near the operating point of the switch. Remote mounting of the switch is the best way to avoid problems.

### Use on steam

Switches should not be applied directly on steam exceeding 15 psig. However, with steam capillary tubing installed between the pressure connection and the switch, steam pressure up to 250 psig can be applied—provided this does not exceed the maximum allowable pressure rating of the switch or the maximum temperature rating at the actuator. Refer to the instruction bulletin supplied with the device.

### Dual-stage operation

The 9012G dual-stage pressure switches provide two distinct levels of control from one device. These switches are most commonly used where dual functions are required, or in sequencing applications such as alarm-shutdowns.

### Differential-pressure operation

The 9012G pressure switches for differential-pressure sensing can monitor changes in the difference between two pressures. These unidirectional devices signal that a predetermined pressure difference was reached, resulting from a widening or narrowing of the difference between two pressures.

**Piston- vs. diaphragm-actuated devices**

Whether to select a piston or diaphragm device depends on several criteria:

- maximum allowable pressure
- range and differential
- surges
- medium (whether hydraulic or pneumatic)

Maximum allowable pressures for piston devices are much higher than for diaphragm devices. Most diaphragm devices have a maximum allowable pressure of 850 psi or less, whereas all piston devices have a maximum allowable pressure of 10,000 psi or more.

Range and differential for diaphragm devices are lower than for piston devices. Many applications call for a low differential, such as 20 psi. This may exclude piston devices, which have a minimum differential of 60 psi or more.

Surges are a part of every hydraulic system. While many are small and have only a small effect on the switch, some are significant and can potentially destroy a pressure switch. Diaphragm devices are the most sensitive to surges and are most easily damaged. Piston devices are more tolerant of surges and last longer in the same application.

Hydraulic systems, which typically use oil-based media, are more demanding applications than pneumatic systems. Pressure switches used in hydraulic applications typically experience higher pressures, have wider pressure variations, and produce more surges, since the medium does not compress. Pneumatic systems, which typically use air, place fewer demands on a system, since these applications typically experience lower pressures and the medium can compress, cushioning the effects of surges. Table 1 offers basic guidelines for determining the selection of a piston- versus a diaphragm-operated pressure switch.

**Piston vs. diaphragm**

<b>Maximum allowable pressures</b>	High	Piston
	Lower	Diaphragm
<b>Pressures</b>	High pressures	Piston
	Low differentials or pressures	Diaphragm
<b>Surges</b>	Constant	Piston
	Minimal	Diaphragm or piston
<b>Media</b>	Hydraulic systems	Piston
	Pneumatic systems	Diaphragm

**Operating points (set points)**

Pressure switches have two operating points:

- Increasing pressure (rising pressure)
- Decreasing pressure (falling pressure)

These operating points are also called the set points of the switch.

**Differential**

The *differential* is the difference in pressure between the rising and falling pressure points. It can be adjustable or fixed.

**Range**

The *range* refers to the pressure limits within which the operating points (settings) can be adjusted. The range of the 9012G pressure switch is tied to the decreasing pressure operating point. Adding the differential to the decreasing pressure operating point determines the increasing pressure operating point.

### Differential

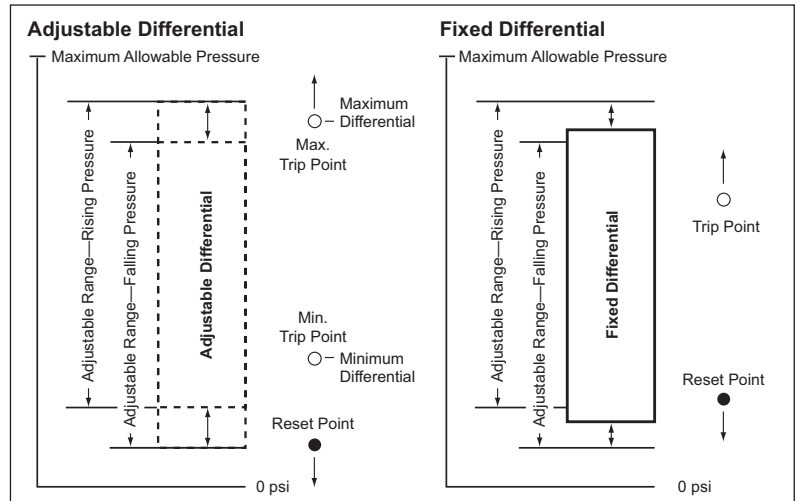

#### Fixed differential

To determine the operating range on rising pressure for a fixed differential switch, add the differential to the decreasing pressure operating point. For example, to determine the range on **increasing** pressure for a 9012GDW5 switch:

- Range on decreasing pressure = 3 to 150 psi
- Fixed differential =  $6.0 \pm 0.8$  psi
- Range on increasing pressure =  $9 \pm 0.8$  to  $156 \pm 0.8$  psi

#### Adjustable differential

For adjustable differential switches, add the minimum differential to the low end of the range and the maximum differential to the high end of the range. For example, to determine the range on **increasing** pressure for a 9012GAW5:

- Range on decreasing pressure = 3 to 150 psi
- Adjustable differential = 6.0 to 30 psi
- Range on increasing pressure = 9 to 180 psi

During the normal operating cycle, system pressure should never exceed the upper limit of the range when using a diaphragm-actuated switch. This greatly reduces the life of the diaphragm. For optimum life, operate the switch in the middle 80% of the range.

#### Maximum allowable pressure

Maximum allowable pressure is the pressure to which a switch can be subjected without causing a change in operating characteristics, shift in settings, or damage to the device.

System pressure surges may occur during machine startup or from valve operation. Surges are not normally detrimental to the life of a switch if the surge is within the maximum allowable pressure rating of the switch. Diaphragm-actuated switches should not be subjected to more than 10 surges per day. More frequent surges greatly reduce the life of the diaphragm.

# 9012G and 9016G Industrial pressure and vacuum switches

9012G pressure and 9016G vacuum switches

Environment	
Environmental specifications	
Conformity to standards	CE, UKCA, IEC 60947.4.1, UL 508, CSA C22-2 n°14
Product certifications	UL Listed and CSA certified as industrial control equipment
Protective treatment	Marine use: HT (does not apply to 9016GVG)
Fluids controlled	Air, water, hydraulic oils, gases, steam (depending on the model)
Materials	Cast aluminum enclosures (9012 NEMA 1 and 9016 GVG are stamped metal enclosure and molded cover)
Operating position	Operates in all positions
Shock resistance	50 g
Degree of protection	Depends on the model
Operating rate (operating cycles/minute)	120 operations/minute max. 9016GVG: 60 operations/minute max.
Repeat accuracy	±2.0% (does not apply to 9016GVG)
Drift	±1.0% of the adjustable range over 1 million operations
Pressure connection	G1/4 (BSP) female, 1/4"-18 NPTF, or 1/2"-14 NPT
Electrical connection	1/2"-14 NPTF, Pg13.5, or ISO M20 (also, 3/4"-14 NPTF available only on NEMA 7 and 9). NEMA 1 is 1/2" conduit entry, unthreaded.

Contact arrangement		
9012G and 9016G machine tool and vacuum switches (except GVG)		
Type	Contact arrangement	Contact symbol
Single Pole Double Throw (SPDT)	1 N.O., 1 N.C.	
Snap switch contains two double-break contact elements (1 N.O., 1 N.C.) that must be used on circuits of the same polarity.		
Double Pole Double Throw (DPDT)	2 N.O., 2 N.C.	
Snap switch contains two electrically separated sets of contact elements allowing use on circuits of opposite polarity. Each set contains two double-break contact elements (1 N.O. and 1 N.C.) that must be used on circuits of the same polarity.		

Circuit ratings										
Contacts	Continuous carrying amperes	AC—50 or 60 Hz						DC		
		Voltage (V)	Inductive 35% power factor				Resistive, 75% power factor Make and break amperes	Voltage (V)	Inductive and resistive	
			Make		Break				Make and break amperes Single throw	Double throw
			A	VA	A	VA				
SPDT	10	120	60	7200	6	720	6	125	0.55	0.22
	10	240	30	7200	3	720	3	250	0.27	0.11
	10	480	15	7200	1.5	720	1.5	301-600 (1)	0.10	—
	—	600	12	7200	1.2	720	1.2			
DPDT	10	120	60	7200	6	720	6	125	0.22	0.22
	10	240	30	7200	3	720	3	250	0.11	0.11
	10	480	15	7200	1.5	720	1.5	600	—	—
	—	600	12	7200	1.2	720	1.2	—	—	—

(1) Continuous carrying ampere rating does not apply.  
Acceptable wire sizes: 12-22 AWG. Recommended terminal clamp torque: 7 lb-in  
Not recommended for use on circuits below 24 V, 20 mA.

Electrical Ratings—9016GVG			
Voltage	AC		DC
	Single Phase	Polyphase	
110 V	2 hp	3 hp	1 hp
220 V	3 hp	5 hp	1 hp
440-550 V	5 hp	5 hp	—
32 V	—	—	0.5 hp

Note: Control Circuit Rating: A600

Interpreting the commercial reference (excluding 9016GVG)				
Use this table for interpretation only. Some combinations are not available.				
Designation		9012G A R 2 2		
Classification	Pressure Switch	Commercial reference		
	Vacuum Switch	9012G		
Actuator Type— Differential Type	Single-Stage Machine Tool	Diaphragm, Low Pressure—Adjustable	A	
		Diaphragm, High Pressure—Adjustable	B	
Piston—Adjustable		C		
Diaphragm, Low Pressure—Fixed		D		
Diaphragm, High Pressure—Fixed		E		
Piston—Fixed		F		
Diaphragm, Low Pressure—Adjustable		G		
Differential-Pressure		Diaphragm, High Pressure—Adjustable	H	
Piston—Adjustable		J		
Dual-Stage		Diaphragm, Low Pressure—Adjustable	K	
	Diaphragm, High Pressure—Adjustable	L		
	Piston—Adjustable	M		
Single-Stage Industrial	Diaphragm, Low Pressure—Adjustable	N		
	Diaphragm, High Pressure—Adjustable	P		
	Piston—Adjustable	Q		
	Diaphragm, Low Pressure—Fixed	R		
	Diaphragm, High Pressure—Fixed	S		
Enclosure, NEMA Type	1	T		
	Open	G		
	7, 9	O		
	4, 4X, 13	R		
Threads	1/4"-18 NPTF	W		
	Metric	blank		
Contacts	Single-pole, double-throw	M		
	Double-pole, double-throw	blank		
Pressure Range (psi)	Diaphragm	0.2-10	1	
		1-40	2	
		Single or Dual Stage, Low Pressure	1.5-75	4
		3-150	5	
		5-250	6	
		Single or Dual Stage, High Pressure	13-425	1
		20-675	2	
		Differential-Pressure, Low Pressure	0-75	1
		0-175	4	
		Differential-Pressure, High Pressure	0-500	1
	Piston	Single or Dual Stage	20-1000	1
		90-2900	2	
		170-5600	3	
		270-9000	4	
Differential-Pressure	0-5000	1		
Vacuum (inHg)	Diaphragm	Single Stage, Low Pressure	0-28	1
		0-25	2	
Options	Factory modifications and accessories		See tables on pages 75, 77 and 83	

9012G machine tool pressure switches for single-stage operation						
Pressure range (psi)—Contacts change on decreasing pressure						
Actuator	Switch style	Range (psi)	Fixed differential	Adjustable differential	Pressure code	
Diaphragm	Single or Dual Stage, Low Pressure	0.2-10	0.6±0.1	0.6-2	1	
		1-40	1.6±0.4	1.6-8	2	
		1.5-75	3.0±0.5	3.5-15	4	
		3-150	6.0±0.8	6.0-30.0	5	
		5-250	10.0±1.5	10.0-49	6	
	Single or Dual Stage, High Pressure	13-425	16±3.5	16-90	1	
		20-675	27±5	27-130	2	
		Differential-Pressure, Low Pressure	0-75	0.25±10	0.25-10	1
		0-175	—	0.5-36	4	
		Differential-Pressure, High Pressure	0-500	—	3-175	1
Piston	Single or Dual Stage	20-1000	89±18	89-200	1	
		90-2900	255±30	255-560	2	
		170-5600	578±110	578-1260	3	
		270-9000	788±140	788-1900	4	
	Differential-Pressure	0-5000	—	15-825	1	

The 9012G single-stage pressure switches are control-circuit rated devices. These switches are used in pneumatic or hydraulic systems on a wide variety of machine and process applications to protect the equipment. They either control or monitor the system pressure.

# 9012G and 9016G industrial pressure and vacuum switches

## 9012G machine tool pressure switches



9012GDW1

### Single-Stage Operation

**Class 9012 single-stage pressure switches** are control circuit rated devices used in pneumatic or hydraulic systems on a wide variety of machine and process applications to protect the equipment and control or monitor the system pressure.

- Type G machine tool switches are available with NEMA 4, 4X, and 13 (IEC IP66) enclosure ratings.
- The NEMA 7 and 9 devices are UL listed for use in the following hazardous locations: Class I, Divisions 1 and 2, Groups C and D; and Class II, Divisions 1 and 2, Groups E, F, and G.
- NEMA 4, 4X, and 13 devices are suitable for use in Class I, Division 2, Groups A, B, C, and D hazardous locations or nonhazardous locations only.
- Enclosure materials are cast aluminum.
- To ensure repeatability and minimize setting drift, pressure settings should fall within the middle 80 percent of the pressure range.

### Fixed differential NEMA 4, 4X, 13 Enclosure

UL Listed and CSA Certified as Industrial Control Equipment

Range on decreasing pressure psig	Approximate differential at mid-range, psig (1)	Maximum allowable pressure, psig	Class 9012 Type	
			SPDT	DPDT
<b>Diaphragm actuated—Nitrile diaphragm, zinc plated steel housing</b>				
0.2-10	0.6 ± 0.1	100	9012GDW1	—
1-40	1.6 ± 0.4	100	9012GDW2	9012GDW22
1.5-75	3.0 ± 0.5	240	9012GDW4	—
3-150	6.0 ± 0.8	475	9012GDW5	9012GDW25
5-250	10.0 ± 1.5	750	9012GDW6	—
13-425	16 ± 3.5	850	9012GEW1	—
20-675	27 ± 5	2000	9012GEW2	—
<b>Piston actuated—#440 stainless steel piston #303 stainless steel housing, Viton® fluorocarbon diaphragm and O-ring, Teflon® retaining ring</b>				
20-1000	59 ± 9	10,000	9012GFW1	—
90-2900	170 ± 15	15,000	9012GFW2	9012GFW22
170-5600	289 ± 55	20,000	9012GFW3	—

### Specifications

<b>Fluids controlled</b>	Air, water, hydraulic oils, gases, steam (depending on the model)	
<b>Pressure connection</b>	1/4"-18 NPTF is standard. For metric threads, add M after the W on all types (2). Other options are available (see page 75).	
<b>Weight (approximate)</b>	3 lb (1.36 kg)	
<b>Voltage limits</b>	600 V	
<b>Continuous current</b>	10 A	
<b>Electrical connections</b>	1/2"-14 NPTF (standard), For Pg 13.5, or ISO M20, see footnote (2).	
<b>Standards/Ratings</b>	CE, UKCA, IEC 60947.4.1, UL 508, CSA C22-2 n°14. UL Marine Listed for use on ships/vessels greater than 65 ft long where ignition protection is not required.	
<b>Temperature ratings</b>	<b>Minimum</b>	<b>Maximum</b>
<b>Ambient</b>	-23 °C (-10 °F)	+85 °C (+185 °F)
<b>Media</b>	Diaphragm: -40 °C (-40 °F)	+120 °C (+250 °F)
	Piston: -26 °C (-15 °F)	
	All with Form Q4: -26 °C (-15 °F)	

### Operating curves

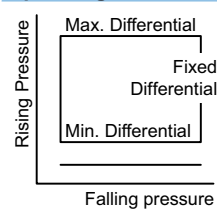

### Contact blocks

1 N.O., 1 N.C.



2 N.O., 2 N.C.

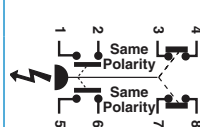

### Connection

Form H17

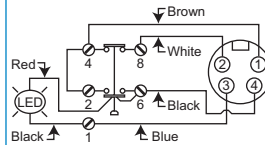

Form H10

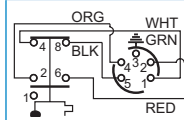

Form H11

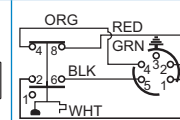

**SPDT** snap switches contain two double-break contact elements (1 N.O., 1 N.C.) that must be used on circuits of the same polarity. **DPDT** snap switches contain two electrically separated sets of contact elements allowing use on circuits of opposite polarity. Each set contains two double-break contact elements (1 N.O., 1 N.C.) that must be used on circuits of the same polarity.

**Acceptable wire sizes:** 12-22 AWG **Recommended terminal clamp torque:** 7 lb-in

- (1) The differential adds to the range setting and determines the operating point on rising pressure.
- (2) To order a Pg13.5 electrical conduit entry and a 1/4"-19 BSP pressure connection, add M12 to the end of the commercial reference, as well as adding "M" after "W" for metric threads. For example:  
 9012GAW1 = 1/2" NPT electrical conduit entry  
 9012GAWM1 = 20 x 1.5 mm electrical conduit entry and 1/4"-19 BSP pressure connection  
 9012GAWM1M12 = Pg13.5 electrical conduit entry and 1/4"-19 BSP pressure connection



# 9012G and 9016G industrial pressure and vacuum switches

## 9012G machine tool pressure switches



9012GAW1



9012GAW5G18

### Adjustable Differential NEMA 4, 4X, 13 Enclosure UL Listed and CSA Certified as Industrial Control Equipment

Range on Decreasing Pressure, psig	Adjustable Differential (1) Approximate at Mid Range	Maximum Allowable Pressure, psig	Class 9012 Type	
			SPDT	DPDT
<b>Diaphragm Actuated—Nitrile Diaphragm, Zinc Plated Steel Housing</b>				
0.2-10	0.7-2	100	9012GAW1	9012GAW21
1-40	2.4-8	100	9012GAW2	9012GAW22
1.5-75	3.9-15	240	9012GAW4	9012GAW24
3-150	6.6-30	475	9012GAW5	9012GAW25
5-250	11-49	750	9012GAW6	9012GAW26
13-425	20-82	850	9012GBW1	9012GBW21
20-675	35-130	2000	9012GBW2	9012GBW22

### Piston Actuated—#440 Stainless Steel Piston. #303 Stainless Steel Housing, Viton® Fluorocarbon Diaphragm and O-ring, Teflon® Retaining Ring

20-1000	65-200	10,000	9012GCW1	9012GCW21
90-2900	187-560	15,000	9012GCW2	9012GCW22
170-5600	425-1050	20,000	9012GCW3	9012GCW23
270-9000	580-1500	25,000	—	9012GCW24

### Specifications

<b>Fluids Controlled</b>	Air, water, hydraulic oils, gases, steam (depending on the model)
<b>Pressure Connection</b>	1/4"-18 NPTF is standard. For metric threads (G1/4 BSP female pressure connection and M20 electrical connection), add M after the W in the commercial reference. For additional pressure connections, see page 75 (1).
<b>Weight (approximate)</b>	3 lb (1.36 kg)
<b>Voltage Limits</b>	600 V
<b>Continuous Current</b>	10 A
<b>Electrical Connections</b>	1/2"-14 NPTF is standard. For metric threads (G1/4 BSP female pressure connection and M20 electrical connection), add M after the W in the commercial reference (2).
<b>Standards/Ratings</b>	CE, UKCA, IEC 60947.4.1, UL 508, CSA C22-2 n°14. UL Marine Listed for use on ships/vessels greater than 65 ft long where ignition protection is not required.

Temperature Ratings		Minimum	Maximum
<b>Ambient</b>		-23 °C (-10 °F)	+85 °C (+185 °F)
	Diaphragm	-40 °C (-40 °F)	+120 °C (+250 °F)
<b>Media</b>	Piston	-26 °C (-15 °F)	
	All with Form Q4	-26 °C (-15 °F)	

Operating Curves	Contact Blocks	Connection
<p>Rising Pressure</p> <p>Max. Differential</p> <p>Adjustable Differential</p> <p>Min. Differential</p> <p>Falling pressure</p>	<p>1 N.O., 1 N.C.</p> <p>2 N.O., 2 N.C.</p> <p>Same Polarity</p>	<p><b>Form H17</b></p> <p><b>Form H10</b></p> <p><b>Form H11</b></p>

**SPDT** snap switches contain two double-break contact elements (1 N.O., 1 N.C.) that must be used on circuits of the same polarity.  
**DPDT** snap switches contain two electrically separated sets of contact elements allowing use on circuits of opposite polarity. Each set contains two double-break contact elements (1 N.O., 1 N.C.) that must be used on circuits of the same polarity.

<b>Acceptable Wire Sizes:</b>	12-22 AWG	<b>Recommended Terminal Clamp Torque:</b>	7 lb-in
-------------------------------	-----------	---	---------

(1) The differential adds to the range setting and determines the operating point on rising pressure.  
 (2) To order a Pg13.5 electrical conduit entry and a 1/4"-19 BSP pressure connection, add M12 to the end of the commercial reference, as well as adding "M" after "W" for metric threads. For example:  
 9012GAW1 = 1/2" NPT electrical conduit entry  
 9012GAWM1 = 20 x 1.5 mm electrical conduit entry and 1/4"-19 BSP pressure connection  
 9012GAWM1M12 = Pg13.5 electrical conduit entry and 1/4"-19 BSP pressure connection

# Photo-electric sensors

XUM, general purpose, single mode function

Miniature design, plastic

Three-wire DC, solid-state output

Potentiometer setting for NO/NC, sensitivity



9012GAR4

**Adjustable Differential**  
**NEMA 7 & 9 Enclosure, Class I & II, Division 1 & 2, Groups C, D, E, F, G**  
**UL Listed as Industrial Control Equipment**

Range on Decreasing Pressure, psig	Adjustable Differential (1) Approximate at Mid Range	Maximum Allowable Pressure, psig	Class 9012 Type SPDT	DPDT
<b>Diaphragm Actuated—Nitrile Diaphragm, Zinc Plated Steel Housing</b>				
1.5-75	8-15	240	9012GAR4	9012GAR24
3-150	16-30	475	9012GAR5	9012GAR25
5-250	23-49	750	9012GAR6	—
13-425	36-82	850	9012GBR1	—

<b>Piston Actuated—#440 Stainless Steel Piston. #303 Stainless Steel Housing, Viton® Fluorocarbon Diaphragm and O-ring, Teflon® Retaining Ring</b>				
90-2900	281-560	15,000	9012GCR2	—
170-5600	638-1050	20,000	9012GCR3	—

**Specifications**

<b>Fluids Controlled</b>	Air, water, hydraulic oils, gases, steam (depending on the model)			
<b>Pressure Connection</b>	1/4"-18 NPTF (standard) or 1/2"-14 NPT. See page 75.			
<b>Weight (approximate)</b>	10 lb (4.54 kg)			
<b>Voltage Limits</b>	600 V			
<b>Continuous Current</b>	10 A			
<b>Electrical Connections</b>	1/2"-14 NPTF, 3/4"-14 NPTF			
<b>Standards/Ratings</b>	CE, UKCA, IEC 60947.4.1, UL 508, CSA C22-2 n°14. UL Marine Listed for use on vessels longer than 65 ft where ignition protection is required.			

Temperature Ratings	Minimum		Maximum	
	<b>Ambient</b>	-23 °C (-10 °F)		+85 °C (+185 °F)
<b>Media</b>	Diaphragm	-40 °C (-40 °F)		+120 °C (+250 °F)
	Piston	-26 °C (-15 °F)		
	All with Form Q4	-26 °C (-15 °F)		

**Operating Curves**      **Contact Blocks**      **Connection**

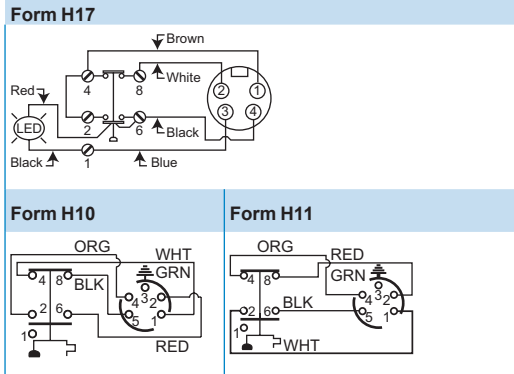
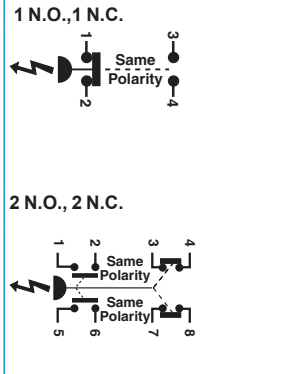
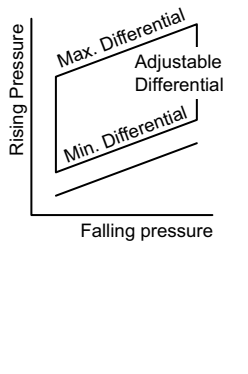

**SPDT** snap switches contain two double-break contact elements (1 N.O., 1 N.C.) that must be used on circuits of the same polarity. **DPDT** snap switches contain two electrically separated sets of contact elements allowing use on circuits of opposite polarity. Each set contains two double-break contact elements (1 N.O., 1 N.C.) that must be used on circuits of the same polarity.

**Acceptable Wire Sizes:** 12-22 AWG      **Recommended Terminal Clamp Torque:** 7 lb-in

(1) The differential adds to the range setting and determines the operating point on rising pressure.



# 9012G and 9016G industrial pressure and vacuum switches

## 9012G pressure switches for differential-pressure operation



9012GJW1

### Differential-Pressure Operation

Pressure switches for differential-pressure operation are used to monitor the change in the difference between two pressures. The 9012G differential-pressure switches are unidirectional devices and are used in applications to signal that a predetermined pressure difference has been reached as a result of a widening or increasing difference between the two pressures. They can also be used in applications to signal that a predetermined pressure difference has been reached as a result of a narrowing or decreasing difference between the two pressures.

NEMA 4, 4X, and 13 devices are suitable for use in Class I, Division 2, Groups A, B, C, and D hazardous locations or nonhazardous locations only.

### Adjustable differential NEMA 4, 4X, 13 Enclosures UL Listed and CSA Certified as Industrial Control Equipment

Working Pressure Range on decreasing X (upper) actuator	Adjustable Difference on Decreasing Pressure (Adds to working pressure) Y (lower) actuator	Adjustable Differential Actuates on increasing pressure (adds to adjustable difference)	Maximum Allowable Pressure	Class 9012 Type	
				SPDT	DPDT

Diaphragm Actuated—Nitrile Diaphragm, Zinc Plated Steel Housing					
0-75	0.25-10	1-2	100	9012GGW1	9012GGW21
0-175	0.5-36	5.6-15	240	9012GGW4	9012GGW24
0-500	3-175	26-90	850	9012GHW1	9012GHW21

### Specifications

<b>Fluids Controlled</b>	Air, water, hydraulic oils, gases, steam (depending on the model)	
<b>Pressure Connection</b>	1/4"-18 NPTF is standard. For metric threads (G1/4 BSP female pressure connection and M20 electrical connection), add M after the W in the commercial reference. For other options, see page 75 (1).	
<b>Weight (approximate)</b>	3 lb (1.36 kg)	
<b>Voltage Limits</b>	600 V	
<b>Continuous Current</b>	10 A	
<b>Electrical Connections</b>	1/2"-14 NPTF (standard), For Pg 13.5, or ISO M20, see footnote (2) on page 72.	
<b>Standards/Ratings</b>	CE, UKCA, IEC 60947.4.1, UL 508, CSA C22-2 n°14. UL Marine Listed for use on vessels greater than 65 ft long where ignition protection is not required.	

	Temperature Ratings	
	Minimum	Maximum
<b>Ambient</b>	-23 °C (-10 °F)	+85 °C (+185 °F)
<b>Media</b>	Diaphragm	-40 °C (-40 °F)
	Piston	-26 °C (-15 °F)
	All with Form Q4	-26 °C (-15 °F)

Operating Curves	Contact Blocks	Connection
		<p><b>1 N.O., 1 N.C.</b></p> <p><b>2 N.O., 2 N.C.</b></p>

**SPDT** snap switches contain two double-break contact elements (1 N.O., 1 N.C.) that must be used on circuits of the same polarity.  
**DPDT** snap switches contain two electrically separated sets of contact elements allowing use on circuits of opposite polarity. Each set contains two double-break contact elements (1 N.O., 1 N.C.) that must be used on circuits of the same polarity.

<b>Acceptable Wire Sizes:</b>	12-22 AWG	<b>Recommended Terminal Clamp Torque:</b>	7 lb-in
-------------------------------	-----------	---	---------



Listed Marine Use



Certified Class 3211-03





9012GKW2

### Dual-Stage Operation

The **9012G dual-stage pressure switches** are designed for use in applications where two separate pressure operations must be controlled by a single pressure monitoring device. These controls are most commonly used where dual functions are required or in sequencing applications such as alarm shutdowns. The spread between the two stages is adjustable, but the differential between the high (rising) and low (falling) operating points of each stage is fixed.

NEMA 4, 4X, and 13 devices are suitable for use in Class I, Division 2, Groups A, B, C, and D hazardous locations or nonhazardous locations only.

### Fixed Differential NEMA 4, 4X, 13 Enclosure UL Listed and CSA Certified as Industrial Control Equipment

Range Setting	Adjustable Spread	Fixed Differential		Maximum Allowable Pressure	SPDT Each Stage
		Stage 1	Stage 2		
Pressure limits between which Stage 1 can be adjusted to operate on decreasing pressure	Add to the range setting to obtain the decreasing operating point of Stage 2	4.0 ± 1.0	6.0 ± 1.5	100	9012GKW2
		6.0 ± 1.5	8.0 ± 2.0	240	9012GKW4
		8.0 ± 2.0	12 ± 3	475	9012GKW5
		14 ± 3	21 ± 5	750	9012GKW6

Diaphragm Actuated—Nitrile Diaphragm, Zinc Plated Steel Housing					
1-40	4.4-20	4.0 ± 1.0	6.0 ± 1.5	100	9012GKW2
1.5-75	6.6-30	6.0 ± 1.5	8.0 ± 2.0	240	9012GKW4
3-150	13.2-75	8.0 ± 2.0	12 ± 3	475	9012GKW5
5-250	24.2-110	14 ± 3	21 ± 5	750	9012GKW6

Piston Actuated—#440 Stainless Steel Piston. #303 Stainless Steel Housing, Viton® Fluorocarbon Diaphragm and O-ring, Teflon® Retaining Ring					
90-2900	176-800	140 ± 30	210 ± 52	15,000	9012GMW2
170-5600	360-1700	275 ± 60	400 ± 100	20,000	9012GMW3

### Specifications

<b>Fluids Controlled</b>	Air, water, hydraulic oils, gases, steam (depending on the model)
<b>Pressure Connection</b>	1/4"-18 NPTF is standard. For metric threads, add M after the W on all types. Other options are available (see page 75). (1)
<b>Weight (approximate)</b>	3 lb (1.36 kg)
<b>Voltage Limits</b>	600 V
<b>Continuous Current</b>	10 A
<b>Electrical Connections</b>	1/2"-14 NPTF (standard), For Pg 13.5, or ISO M20, see footnote (2) on page 7.
<b>Standards/Ratings</b>	CE, UKCA, IEC 60947.4.1, UL 508, CSA C22-2 n°14. UL Marine Listed for use on vessels greater than 65 ft long where ignition protection is not required.

Temperature Ratings	Minimum		Maximum	
	<b>Ambient</b>	-23 °C (-10 °F)		+85 °C (+185 °F)
<b>Media</b>	Diaphragm	-40 °C (-40 °F)		+120 °C (+250 °F)
	Piston	-26 °C (-15 °F)		
	All with Form Q4	-26 °C (-15 °F)		

Operating Curves	Contact Blocks	Acceptable Wire Sizes:
	1 N.O., 1 N.C. 	12-22 AWG  Recommended Terminal Clamp Torque: 7 lb-in



Listed Marine Use



Certified Class 3211-03



### Wiring Diagrams for Receptacles and Connectors. Factory Modifications (Forms).

#### Prewired 5-pin male receptacle

##### Form H10

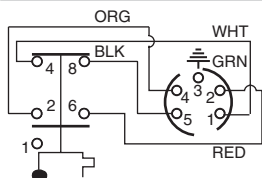

##### Form H11

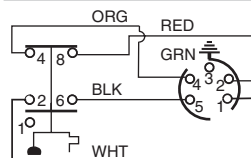

#### Micro connector, 4-pin, for 24 Vdc pilot light

##### Form H17

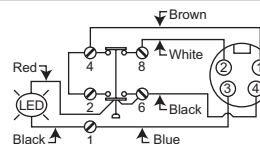

**Modifications, Renewal Parts, and Accessories**

**9012G Machine Tool Factory Modifications (Forms)**

Modification	Applies to	Form	
Lock on rising pressure, manual reset only	Available on GDW, GDWM, GEW, GEWM, GFW, GFWM only	E3	
120 Vac or Vdc neon pilot light	Available on all GAW-GMW and GAWM-GFWM	clear lens G17 red lens G18	
	For pilot light conversion kits: See 9998PC306-308	clear lens G21 red lens G22	
24 Vdc only LED			
24 Vdc LED pilot light with green lens	Class 9012 GAW-GMW and GAWM-GFWM, or Class 9016 GAW	G23	
SPDT snap switch rated 1.1 A at 125 Vdc (minimum differential doubles)	Available on GAR-GFR, GAW-GJW, and GAWM-GFWM	H3	
Prewired 5-pin male receptacle: Brad Harrison #41310 or interchangeable Crouse-Hinds receptacle at our convenience. For use with Brad Harrison female portable plug #41306, 41307, 41308 or equal	Available on GAW-GJW single pole devices only. <b>See wiring diagrams on page 80.</b>	H10 or H11	
Micro connector, 4-pin, for 24 Vdc pilot light (see diagram on page 80)	G•W (single pole only), except GAW2 and Form B2.	H17	
External range adjustment with range scale window	With knob	GAW-GFW, GAWM-GFWM, and GKW-GMW	K
	Slotted for screwdriver	GAW-GFW, GAWM-GFWM, and GKW-GMW	K1
Pg 13.5 conduit thread and 1/4"-19 BSP pressure connection	GAW-GFW and GKW-GMW	M12	
#316 stainless steel flange	Standard nitrile diaphragm	GAR, GBR, GDR, GER, GAW, GBW, GDW, GEW, GGW, GHW, GAWM, GBWM, GDWM, GEWM, GKW, GLW, except Types 1 and 21	Q1
	Ethylene propylene diaphragm	Available on all GGW, GHW except GGW-1, 21. Available on all GAR, GBR, GDR, GER, GAW, GBW, GDW, GEW, GAWM, GBWM, GDWM, GEWM, GKW, GLW, except Types 1 and 21	Q3
	Viton® fluorocarbon diaphragm	GAR, GAW, GBR, GBW, GDR, GDW, GER, GEW, GGW, GHW, GAWM, GBWM, GDWM, GEWM, GKW, GLW, except Types 1 and 21	Q4
Range scale window (standard with Forms K and K1)	GAW-GMW, GAWM-GFWM	V1	
Special factory setting specified (If indicating only one special setting, specify whether this setting is on increasing or decreasing pressure.)	All 9012G	Y1	
Pressure connection Not available in combination with Forms Q1, Q3, Q4	1/4"-18 NPT external thread	GAR, GAW, GDR, GDW, GGW, GKW	Z
	1/2"-14 NPT external thread, 1/4"-18 NPTF internal thread	GAR, GAW, GDR, GDW, GGW, GKW	Z16
	7/16"-20 UNF-2B internal thread	GAR-GFR; GAW-GMW	Z18

**9012G Pressure Switches, Factory Modifications (Forms) for Renewal Parts Kits, Class 9998**

For suffixes for renewal parts kits, see the table below.

Modification	Applies to Parts Kit Type	Form	
SPDT snap switch rated 1.1 A at 125 Vdc (minimum differential doubles)	PC313	H3	
#316 stainless steel flange	Standard nitrile diaphragm	PC177-179, PC268, 269 PC265-267	Q1
	Ethylene propylene diaphragm	PC177-178, PC268, 269 PC266, 267	Q3
	Viton® fluorocarbon diaphragm	PC177-178, PC268, 269 PC265-267	Q4
Pressure connection	1/4"-18 NPT external thread	PC265-269	Z
	1/2"-14 NPT external thread, 1/4"-18 NPTF internal thread	PC265-269	Z16
	7/16"-20 UNF-2B internal thread	PC177, 178, PC265-273	Z18



9012GRG5

Fixed Differential Open Type or NEMA 1 Enclosure UL Listed and CSA Certified as Industrial Control Equipment				
Range on Decreasing Pressure, psig	Approximate Differential (1) At Mid Range, psig	Maximum Allowable Pressure, psig	Class 9012 Type Open Type   NEMA 1	
<b>Diaphragm Actuated—Nitrile Diaphragm, Zinc Plated Steel Housing</b>				
1.5-75	2.2 ± 0.4	240	9012GRO4	9012GRG4
3-150	4.2 ± 1	475	–	9012GRG5
<b>Piston Actuated—#440 Stainless Steel Piston. #303 Stainless Steel Housing, Viton® Fluorocarbon Diaphragm and O-Ring, Teflon® Retaining Ring</b>				
20-1000	49 ± 10	10,000	–	9012GTG1
<b>Specifications</b>				
<b>Fluids Controlled</b>	Air, water, hydraulic oils, gases, steam (depending on the model)			
<b>Pressure Connection</b>	1/4"-18 NPTF (standard), 1/2"-14 NPT, or 7/16"-20 UNF-2B. See Forms table on page 77.			
<b>Weight (approximate)</b>	<b>Type 1:</b> 2 lb (0.91 kg); <b>Open:</b> 1.7 lb (0.77)			
<b>Voltage Limits</b>	600 V			
<b>Continuous Current</b>	10 A			
<b>Electrical Connections</b>	1/2" conduit entry, unthreaded			
<b>Standards/Ratings</b>	CE, UKCA, IEC 60947.4.1, UL 508, CSA C22-2 n°14			
<b>Temperature Ratings</b>	<b>Minimum</b>	<b>Maximum</b>		
<b>Ambient</b>	-23 °C (-10 °F)	+85 °C (+185 °F)		
<b>Media</b>	Diaphragm	+120 °C (+250 °F)		
	Piston			
	All with Form Q4			
<b>Operating Curves</b>	<b>Contact Blocks</b>			
	<b>SPDT Form C contacts</b> 		<b>Acceptable Wire Sizes:</b> 12-22 AWG	
			<b>Recommended Terminal Clamp Torque:</b> 7 lb-in	

(1) Determines the operating point on rising pressure.



Certified Class 3211-03

# 9012G and 9016G industrial pressure and vacuum switches

## 9012G industrial pressure switches

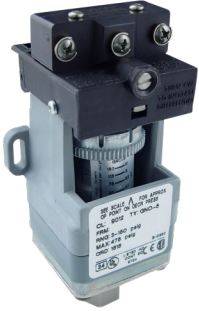

9012GNO5



9012GNG1

**Adjustable Differential**  
**Open Type or NEMA 1 Enclosure**  
**UL Listed and CSA Certified as Industrial Control Equipment**

Range on Decreasing Pressure psig	Approximate Mid Range (1) Differential (adds to the decreasing set point)	Maximum Allowable Pressure psig	Class 9012 Type	
			Open Type	NEMA 1

Diaphragm Actuated—Nitrile Diaphragm, Zinc Plated Steel Housing				
0.2-10	0.6-1.0	100	–	9012GNG1
1-40	1.6-5.0	100	–	9012GNG3
1.5-75	2.5-6.5	240	9012GNO4	9012GNG4
3-150	4.8-13	475	9012GNO5	9012GNG5
5-250	8.5-20.5	750	9012GNO6	9012GNG6
13-425	20-41	850	–	9012GPG1
20-675	35-66	2000	–	9012GPG2

**Piston Actuated—#440 Stainless Steel Piston.**  
**#303 Stainless Steel Housing, Viton® Fluorocarbon Diaphragm and O-Ring, Teflon® Retaining Ring**

20-1000	56-98	10,000	–	9012GQG1
90-2900	162-308	15,000	–	9012GQG2
170-5600	355-563	20,000	–	9012GQG3

**Specifications**

<b>Fluids Controlled</b>	Air, water, hydraulic oils, gases, steam (depending on the model)			
<b>Pressure Connection</b>	1/4"-18 NPTF (standard), G1/4 (BSP) female, or 1/2"-14 NPT. See Forms in the table below.			
<b>Weight (approximate)</b>	<b>Type 1:</b> 2 lb (0.91 kg); <b>Open:</b> 1.7 lb (0.77)			
<b>Voltage Limits</b>	600 V			
<b>Continuous Current</b>	10 A			
<b>Electrical Connections</b>	1/2" conduit entry, unthreaded			
<b>Standards/Ratings</b>	CE, UKCA, IEC 60947.4.1, UL 508, CSA C22-2 n°14			

Ambient	Temperature Ratings	
	Minimum	Maximum
Diaphragm	-23 °C (-10 °F)	+85 °C (+185 °F)
Piston	-40 °C (-40 °F)	+120 °C (+250 °F)
Media	All with Form Q4: -26 °C (-15 °F)	

**Operating Curves**      **Contact Blocks**

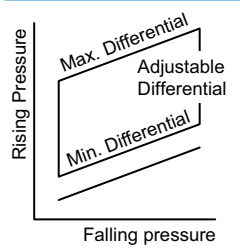

<b>SPDT Form C contacts</b>	<b>Acceptable Wire Sizes:</b> 12-22 AWG  <b>Recommended Terminal Clamp Torque:</b> 7 lb-in

(1) Determines the operating point on rising pressure.

**Factory Modifications (Forms) for 9012G Pressure Switches, Open Type or NEMA 1**  
**UL Listed and CSA Certified as Industrial Control Equipment**

Modification	Applies to	Form
Diaphragm	Standard Nitrile in #316 stainless steel housing	Q1
	Ethylene propylene in #316 stainless steel housing	Q3
	Viton® fluorocarbon in #316 stainless steel housing	Q4
Pressure connection	1/4"-18 NPT external thread	Z
	1/2"-14 NPT external thread, 1/4"-18 NPTF internal thread. Standard actuator only.	Z16
	7/16"-20 UNF-2B internal thread	Z18

# 9012G and 9016G industrial pressure and vacuum switches

## 9016G vacuum switches

### Control applications



9016GAW2

#### 9016GAW Switches for Sensitive Control Applications

9016GAW vacuum switches have double throw contacts. Normally open and normally closed circuits allow the use of these controls for standard or reverse action applications.

**Standard controls** can be mounted from the front using the bracket provided. Two mounting screws are required for firm attachment to any smooth, flat surface. Allowance must be made for flange projection.

**Controls with the Form F modification** include two mounting feet with 9/32" mounting holes on 3-3/4 in. centers. The Range and Differential adjustments are accessed by removing the front cover.

- Maximum allowable positive pressure: 100 psig.
- Diaphragms are oil resisting, nitrile butadiene rubber (Buna-N).
- For electrical ratings and temperature limitations, see table on page 68.
- For dimensions and modifications, see page 80.

#### 9016GAW Vacuum Switch for Control Applications, Diaphragm Actuated

Range on Decreasing Vacuum (inHg)	Adjustable Differential (inHg) Adds to Range (1)		Contact Arrangement	Pipe Tap (NPTF)	Class 9016 Type NEMA Enclosure Type 4, 4X & 13
	@ Minimum Range	@ Mid-Range			
0-28.7	0.8-9	1.3-7.4	1 N.O.-1 N.C.	1/4"-18	9016GAW1
0-25	5-20	5-20	1 N.O.-1 N.C.	1/4"-18	9016GAW2
0-28.3	1-9	1.7-7.4	2 N.O.-2 N.C.	1/4"-18	9016GAW21
0-25	5-20	5-20	2 N.O.-2 N.C.	1/4"-18	9016GAW22

#### Specifications

<b>Fluids Controlled</b>	Air, water, hydraulic oils, gases, steam (depending on the model)	
<b>Pressure Connection</b>	<b>NEMA 4, 4X &amp; 13:</b> 1/4"-18 NPTF (standard), G1/4 (BSP) female, or 1/2"-14 NPT. <b>NEMA 7 &amp; 9:</b> 1/4" NPTF	
<b>Weight (approximate)</b>	Type 4, 4X, and 13: 3 lb (1.36 kg); Type 7 & 9: 10 lb (4.54 kg)	
<b>Voltage Limits</b>	600 V	
<b>Continuous Current</b>	10 A	
<b>Electrical Connections</b>	<b>NEMA 4, 4X &amp; 13:</b> 1/2"-14 NPTF <b>NEMA 7 &amp; 9:</b> 3/4"-14 NPTF	
<b>Standards/Ratings</b>	CE, UKCA, IEC 60947.4.1, UL 508, CSA C22-2 n°14	
<b>Temperature Ratings</b>	<b>Minimum</b>	<b>Maximum</b>
<b>Ambient</b>	-23 °C (-10 °F)	+85 °C (+185 °F)
<b>Diaphragm</b>	-40 °C (-40 °F)	+120 °C (+250 °F)
<b>Media</b>	Piston	-26 °C (-15 °F)
	All with Form Q4	-26 °C (-15 °F)

#### Operating Curves

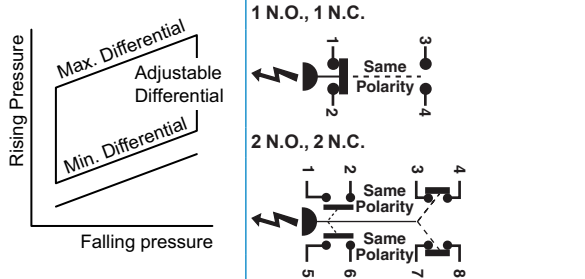

#### Connection

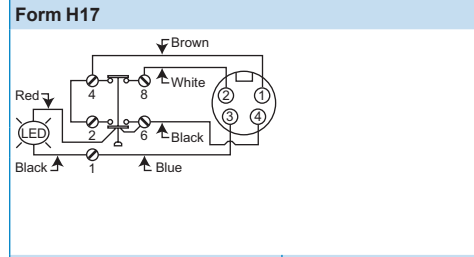

**SPDT** snap switches contain two double-break contact elements (1 N.O., 1 N.C.) that must be used on circuits of the same polarity.  
**DPDT** snap switches contain two electrically separated sets of contact elements allowing use on circuits of opposite polarity. Each set contains two double-break contact elements (1 N.O., 1 N.C.) that must be used on circuits of the same polarity.

#### Form H10

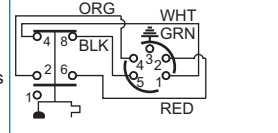

#### Form H11

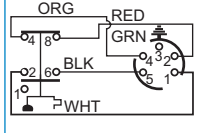

<b>Acceptable Wire Sizes:</b>	12-22 AWG	<b>Recommended Terminal Clamp Torque:</b>
-------------------------------	-----------	---

(1) Add the Differential to the Range to obtain the operating point on increasing vacuum (within vacuum limitations). The differential increases linearly over the range. The minimum differential doubles with NEMA 7 & 9 enclosures.





# 9012G and 9016G industrial pressure and vacuum switches

## 9016G vacuum switches

### Power applications



9016GVG1J09E



9016GVG1J10F

#### 9016GVG Power Switches

The 9016GVG1 is designed as a companion to the 9036GG float switches in common use on vacuum heating pumps. Electrical ratings of float and vacuum switch types are equal.

For dimensions and modifications, see page 80.

#### 9016GVG Vacuum Switch for Power Applications NEMA 1 Enclosure Contacts Open on Increasing Vacuum

Cut-Out Range, inHg	Approximate Adjustable Differential, inHg	Cut-In Range, inHg	Poles	Pressure Connection	Vacuum Setting, inHg	NEMA 1 Enclosure Class 9016 Type (1)
5-25	5-10 inHg	0-20	2	1/4"-18 NPSF	3-8	9016GVG1J09●
					16.5-25	9016GVG1J10●
					17-22	9016GVG1J11●
					18-23	9016GVG1J12●
					20-25	9016GVG1J13●
					Specify other vacuum (minimum order quantity: 4 pieces)	9016GVG1J99●

#### Specifications

<b>Fluids Controlled</b>	Air, water, hydraulic oils, gases, steam (depending on the model)	
<b>Pressure Connection</b>	1/4"-18 NPTF (standard), G1/4 (BSP) female, or 1/2"-14 NPT. See Forms table, page 83.	
<b>Max. Allowable Positive Pressure</b>	100 psig	
<b>Weight (approximate)</b>	2 lb (0.91)	
<b>Voltage Limits</b>	600 V	
<b>Continuous Current</b>	10 A	
<b>Electrical Connections</b>	3 knockouts for 1/2" conduit	
<b>Standards/Ratings</b>	CE, UKCA, IEC 60947.4.1, UL 508, CSA C22-2 n°14	
<b>Temperature Ratings</b>	<b>Minimum</b>	<b>Maximum</b>
<b>Ambient</b>	-23 °C (-10 °F)	+85 °C (+185 °F)
<b>Media</b>	Diaphragm	+120 °C (+250 °F)
	Piston	
	All with Form Q4	-26 °C (-15 °F)

#### Operating Curves

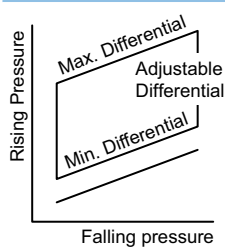

#### Contact Blocks

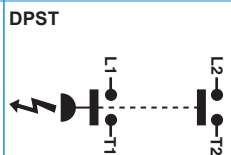

#### Acceptable Wire Sizes:

8-14 AWG

#### Recommended Terminal Clamp Torque:

22-27 lb-in

For other ratings and specifications, see page 68.

#### (1) Available Modifications for 9016GVG Vacuum Switches

Description	Form
3-way lever plus nameplate with marking: <i>Float only—Vacuum and Float—Continuous</i> (factory modification only)	E
Mounting bracket (for retrofit, order 9049A53 bracket kit)	F
Reverse action, normally open contacts	R
1/4 in. male pipe connection (1/4"-18 NPT, external thread) (for retrofit, use 1/4" pipe nipple)	Z



### Machine Tool Pressure Switch Dimensions

#### 9012GAW, GDW, GWK 1, 21

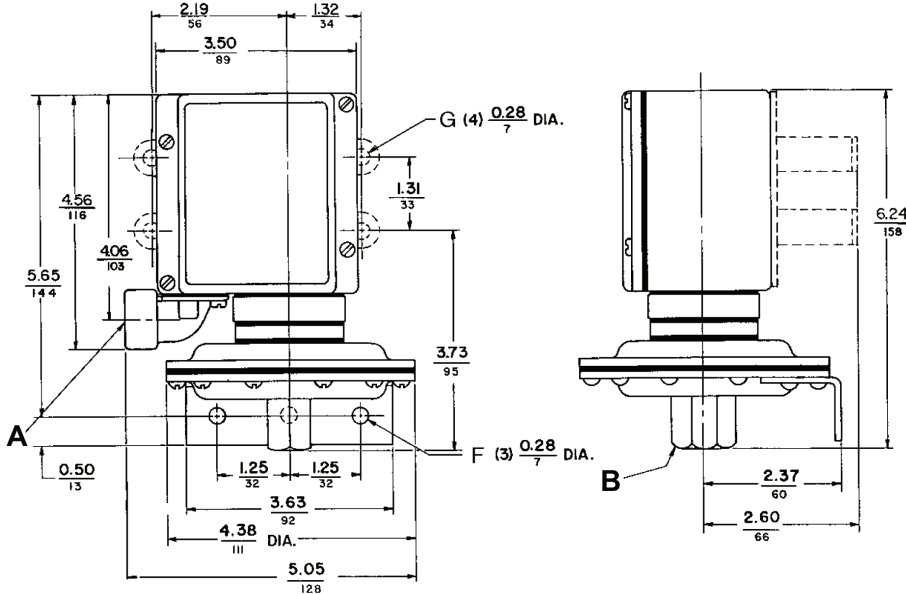

**A:** Conduit connection: G•W = 1/2-14 NPT; G•WM = 20mm BS4568, Form M12 = Pg13.5; DIN40430.  
**B:** Pressure connection: G•W = 1/4"-18 NPTF; G•WM = 8; Form M14 = G 1/4 BS 2779; RP1/4 ISO 711; R 1/4 DIN 2999; GJ 1/4 UN1339.

#### 9012GAW, GBW, GCW, GDW, GEW, GFW, GWK, GLW, and GMW (except GAW, GDW, GWK 1, 21)

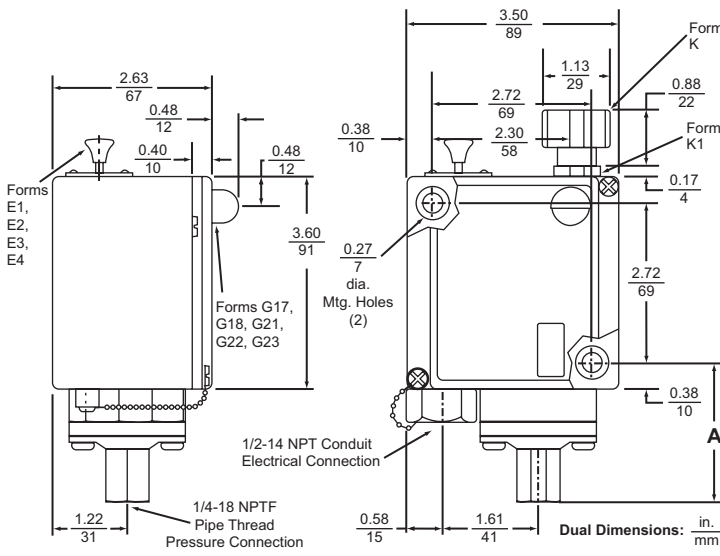

Type	Dimension A, in. (mm)
GAW, GDW, GWK 2, 4, 5, 6, 22, 24, 25, 26	2.33 (59)
GBW, GEW, GLW 1, 2, 21	2.23 (57)
GCW, GFW, GMW 1, 2, 3, 4, 21, 22, 23, 24	3.15 (80)

NOTE: Dimensions change with metric thread.  
 For flange and mounting bracket dimensions for low pressure device, see figure on page 83.

# 9012G and 9016G industrial pressure and vacuum switches

## 9012G pressure switches

### 9012GGW, GHW, GJW (Differential-Pressure)

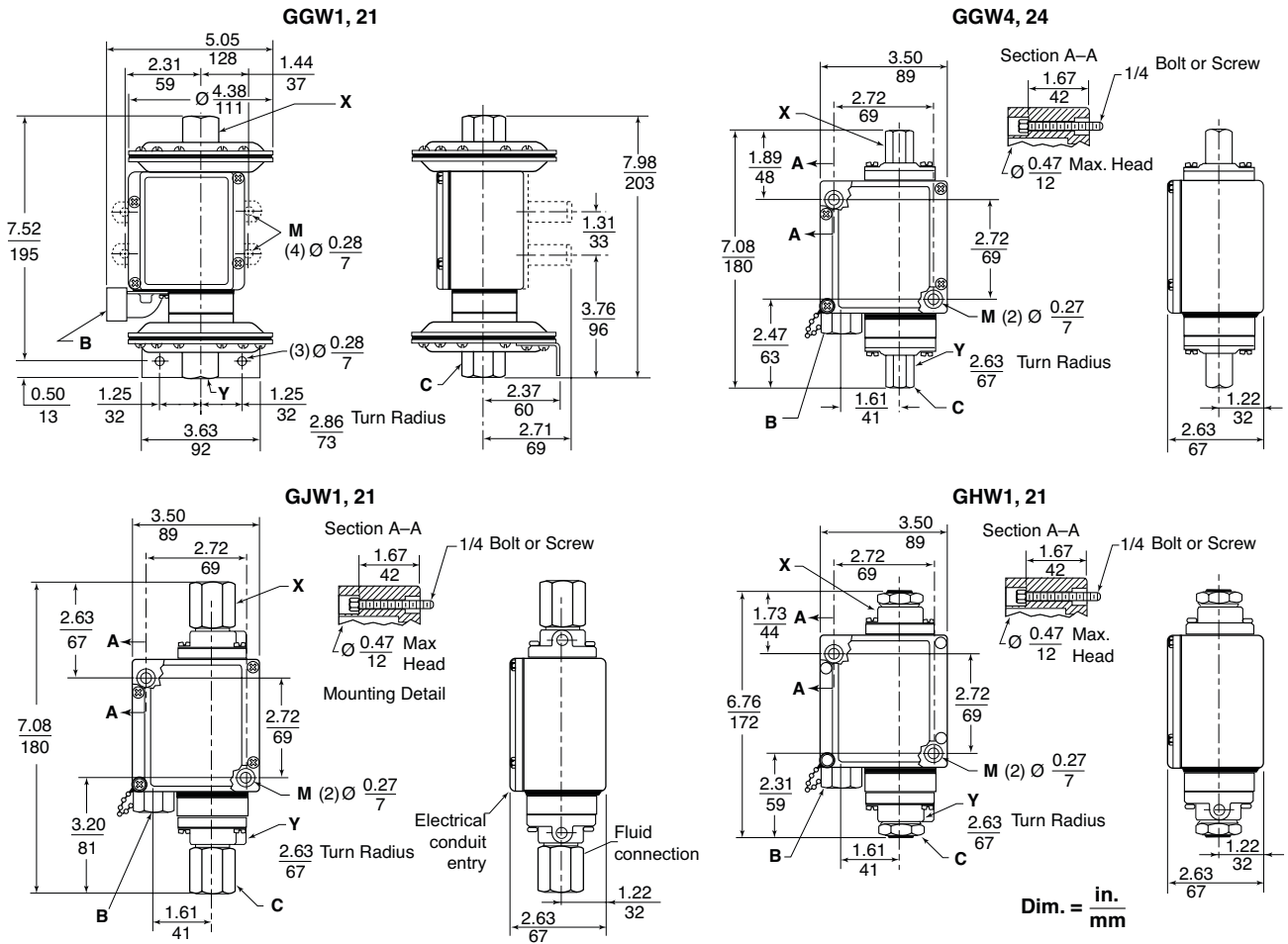

### 9012GAR, GBR, GCR, GDR, GER, and GFR

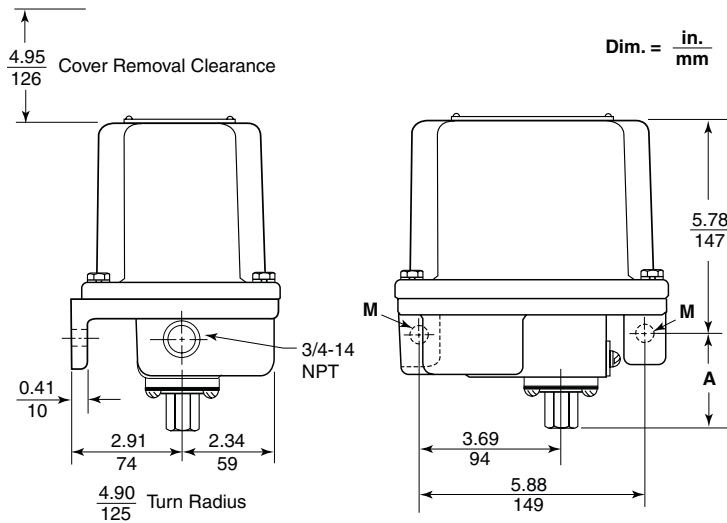

### Dimension A for 9016G-R Switches

Type	Dimension A, in. (mm)
GAR4, 5, 6, 24, 25, 26	1.42 (36)
GBR1, 2, 21, 22; GCR1, 21	1.32 (34)
GCR2, 3, 4, 22, 23, 24	2.24 (57)
GDR1, 2, 21, 22	2.02 (56)
GDR4, 5, 6, 24, 25, 26	1.42 (36)
GER1, 2, 21, 22; GFR1, 21	1.32 (34)
GFR2, 3, 4, 22, 23, 24	2.24 (57)

# 9012G and 9016G industrial pressure and vacuum switches

## 9012G pressure switches

### 9012GNO1, GRO1

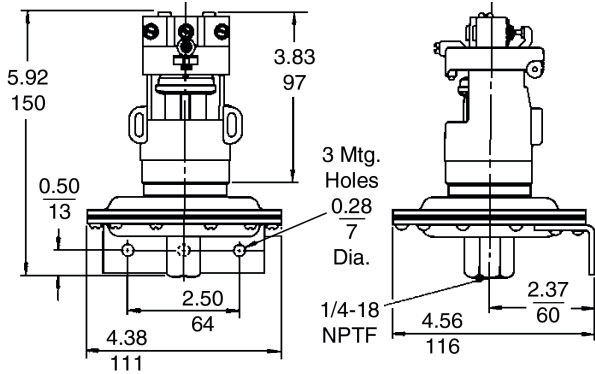

### 9012GNG1, GRG1

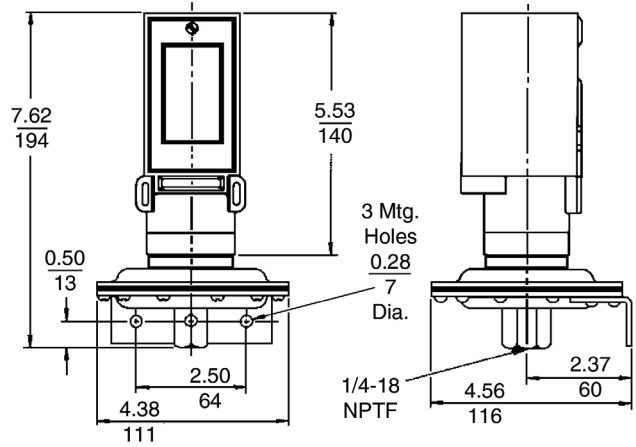

### 9012GNO, GRO

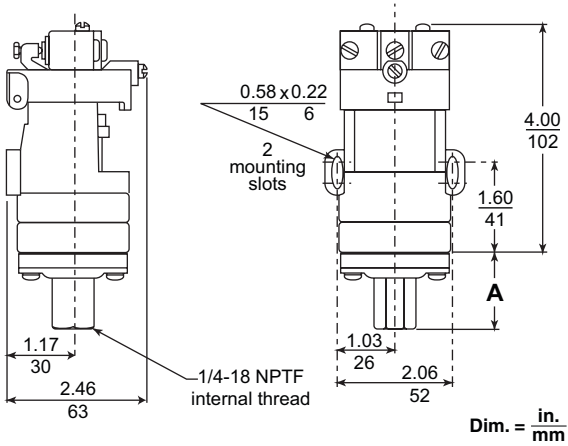

### 9012GNG, PPG, GQG, GRG, GSG, and GTG

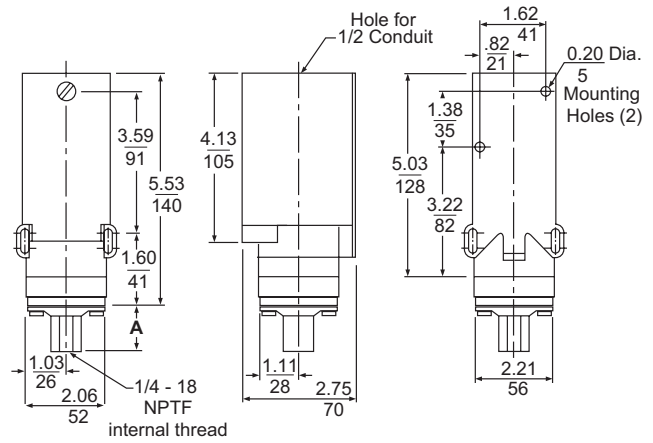

### Dimension A for 9012G•O Switches

9012	Dimension A, in. (mm)
GNO, GRO 3, 4, 5, 6	1.41 (36)
GPO, GSO 1, 2, 3	1.31 (33)
GQO, GTO 1, 2, 3, 4	2.24 (57)

### Dimension A for 9012G•G Switches

9012	Dimension A, in. (mm)
GNG, GRG 3, 4, 5, 6	1.41 (36)
GPG, GSG 1, 2, 3	1.31 (33)
GQG, GTG 1, 2, 3, 4	2.24 (57)

Vacuum Switch Dimensions and Modifications

9016GAW Control Vacuum Switches—Dimensions

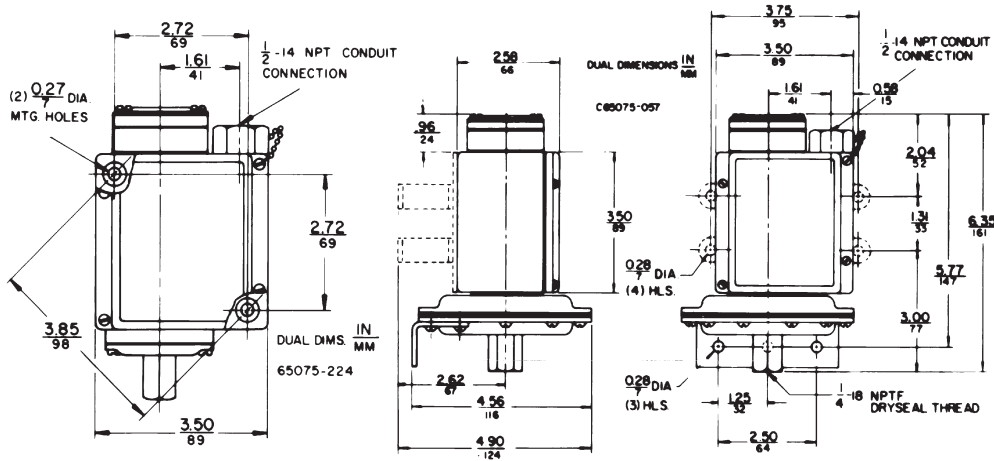

9016GAW Vacuum Switches—Available Modifications

Description	Form
Mounting feet (GAW 1, 21 only)	F
Viton® diaphragm with #316 stainless steel flange	Q4
Range scale window (standard with Forms K and K1)	V1
Special setting specified (If indicating only one special setting, specify whether this setting is on increasing or decreasing pressure.)	Y1
1/4"-18 NPT external thread pressure connection	Z
1/2"-14 NPT external thread, 1/4"-18 NPTF internal thread pressure connection (standard actuator only)	Z16

9016GVG Power Vacuum Switches-Dimensions

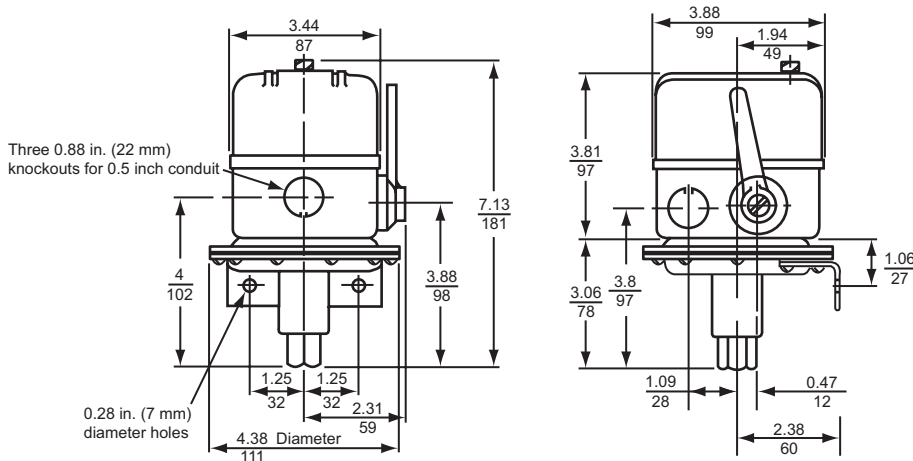

9016GVG Vacuum Switches-Available Modifications

Description	Form
3-way lever plus nameplate with marking: Float only-Vacuum and Float-Continuous (factory modification only)	E
Mounting bracket (for retrofit, order 9049A53 bracket kit)	F
Reverse action, normally open contacts	R
1/4 in. male pipe connection (1/4"-18 NPT, external thread) (for retrofit, use 1/4" pipe nipple)	Z

#					
9012GAR4	72	9012GCW21	71	XMLA160N2C11	47
9012GAR5	72	9012GCW22	71	XMLA160N2S11	47
9012GAR6	72	9012GCW23	71	XMLA300D2C11	51
9012GAW1	71	9012GCW24	71	XMLA300D2S11	51
9012GAW2	71	9012GDW22	70	XMLA300D2S12	51
9012GAW4	71	9012GDW25	70	XMLA300D2S13	51
9012GAW5	71	9012GFW22	70	XMLA300N2S11	51
9012GAW6	71	9012GGW21	73	XMLA500D2S13	54
9012GBR1	72	9012GGW24	73	XMLA500N2C11	54
9012GBW1	71	9012GHW21	73	XMLAM01V2S11	19
9012GBW2	71	9016GAW21	78	XMLB001R2S11	26
9012GCR2	72	9016GAW22	78	XMLB002A2S11	28
9012GCR3	72	9016GVG1J09●	79	XMLB002A2S12	28
9012GCW1	71	9016GVG1J10●	79	XMLB002B2S11	28
9012GCW2	71	9016GVG1J11●	79	XMLB004A2C11	31
9012GCW3	71	9016GVG1J12●	79	XMLB004A2S11	31
9012GDW1	70	9016GVG1J13●	79	XMLB004A2S12	31
9012GDW2	70	9016GVG1J99●	79	XMLB004A2S13	31
9012GDW4	70			XMLB004B2S11	31
9012GDW5	70	<b>X</b>		XMLB010A2C11	34
9012GDW6	70	XMLZL001	57	XMLB010A2S11	34
9012GEW1	70	XMLZL014	57	XMLB010A2S12	34
9012GEW2	70	XMLA001R2S11	25	XMLB010A2S13	34
9012GFW1	70	XMLA001S2S11	25	XMLB010B2S11	34
9012GFW2	70	XMLA002A2C11	27	XMLB010C2C11	34
9012GFW3	70	XMLA002A2S11	27	XMLB010C2S11	34
9012GGW1	73	XMLA002A2S12	27	XMLB020A2S11	38
9012GGW4	73	XMLA002C2S11	27	XMLB020A2S12	38
9012GHW1	73	XMLA004A2C11	30	XMLB020A2S13	38
9012GKW2	74	XMLA004A2S13	30	XMLB020B2S11	38
9012GKW4	74	XMLA004B2S11	30	XMLB020C2S11	38
9012GKW5	74	XMLA010A2C11	33	XMLB020C2S12	38
9012GKW6	74	XMLA010A2S11	33	XMLB035A2C11	42
9012GMW2	74	XMLA010A2S12	33	XMLB035A2S11	42
9012GMW3	74	XMLA010A2S13	33	XMLB035B2S11	42
9012GNG1	77	XMLA010B2S11	33	XMLB070D2S11	46
9012GNG3	77	XMLA010C2S11	33	XMLB070N2S11	46
9012GNG4	77	XMLA020A2C11	37	XMLB160D2C11	48
9012GNG5	77	XMLA020A2S11	37	XMLB160D2S11	48
9012GNG6	77	XMLA020A2S12	37	XMLB160D2S12	48
9012GNO4	77	XMLA020A2S13	37	XMLB160N2S11	48
9012GNO5	77	XMLA020B2C11	37	XMLB300D2C11	52
9012GNO6	77	XMLA020B2S11	37	XMLB300D2S11	52
9012GPG1	77	XMLA020B2S12	37	XMLB300D2S12	52
9012GPG2	77	XMLA020C2S11	37	XMLB300N2S12	52
9012GQG1	77	XMLA035A2C11	41	XMLB500D2C11	55
9012GQG2	77	XMLA035A2S11	41	XMLB500D2S11	55
9012GQG3	77	XMLA035A2S12	41	XMLB500D2S12	55
9012GRG4	76	XMLA035B2C11	41	XMLB500N2C11	55
9012GRG5	76	XMLA035B2S11	41	XMLB500N2S11	55
9012GRO4	76	XMLA035C2C11	41	XMLB500N2S12	55
9012GTG1	76	XMLA070D2C11	45	XMLBL35R2S11	23
9016GAW1	78	XMLA070D2S11	45	XMLBL35R2S13	23
9016GAW2	78	XMLA070D2S12	45	XMLBM02V2C11	20
9012GAR24	72	XMLA070D2S13	45	XMLBM02V2S11	20
9012GAR25	72	XMLA070E2S11	45	XMLBM02V2S12	20
9012GAW21	71	XMLA070E2S13	45	XMLBM05A2S11	22
9012GAW22	71	XMLA070N2S11	45	XMLBS02B2S11	28
9012GAW24	71	XMLA070N2S12	45	XMLBS04B2S11	31
9012GAW25	71	XMLA160D2C11	47	XMLBS04B2S12	31
9012GAW26	71	XMLA160D2S11	47	XMLBS35R2S11	23
9012GBW21	71	XMLA160D2S12	47	XMLBS35R2S12	23
9012GBW22	71	XMLA160D2S13	47	XMLC002B2S11	29
		XMLA160E2S11	47	XMLC004B2S11	32
				XMLC004B2S12	32
				XMLC010B2S11	35
				XMLC010C2S11	35
				XMLC020B2S11	39
				XMLC020B2S12	39
				XMLC035B2S12	43
				XMLC160D2S11	49
				XMLC160D2S12	49
				XMLC300D2S11	53
				XMLC300D2S12	53
				XMLC300D2S13	53
				XMLCS02B2S11	29
				XMLCS02B2S12	29
				XMLCS02B2S13	29
				XMLCS04B2S11	32
				XMLCS04B2S12	32
				XMLCS10A2S11	35
				XMLCS35R2S11	24
				XMLCS35R2S12	24
				XMLCS35R2S13	24
				XMLD010B1S11	36
				XMLD020C1S12	40
				XMLD035B1S11	44
				XMLD160D1S13	50
				XMLD500D1S11	56
				XMLDM02V1S11	21
				XZCC43FCP40B	57
				XZCR1523062K1	57

[www.tesensors.com](http://www.tesensors.com)

The information provided in this catalogue contains description of products sold by TMSS France, its subsidiaries and other affiliated companies ("Offer") with technical specifications and technical characteristics of the performance of the corresponding Offer.

The content of this document is subject to revision at any time without notice due to continued progress in methodology, design and manufacturing.

To the extent permitted by applicable law, no responsibility or liability is assumed by TMSS France, its subsidiaries and other affiliated companies for any type of damage arising out of or in connexion with (a) informational content of this catalogue not conforming with or exceeding the technical specifications, or (b) any error contained in this catalogue, or (c) any use, decision, act or omission made or taken on the basis of or in reliance on any information contained or referred to in this catalogue.

**NEITHER TMSS FRANCE, ITS SUBSIDIARIES, NOR ITS OTHER AFFILIATES, AS THE CASE MAYBE, MAKE NO WARRANTY OR REPRESENTATION OF ANY KIND, WHETHER EXPRESS OR IMPLIED, AS TO WHETHER THIS CATALOGUE OR ANY INFORMATION CONTAINED THEREIN SUCH AS PRODUCTS WILL MEET REQUIREMENTS, EXPECTATIONS OR PURPOSE OF ANY PERSON MAKING USE THEREOF.**

Telemecanique™ Sensors is a trademark of Schneider Electric Industries SAS used under license by TMSS France. Any other brands or trademarks referred to in this catalogue are property of TMSS France or, as the case may be, of its subsidiaries or other affiliated companies. All other brands are trademarks of their respective owners. This catalogue and its content are protected under applicable copyright laws and provided for informative use only.

No part of this catalogue may be reproduced or transmitted in any form or by any means (electronic, mechanical, photocopying, recording, or otherwise), for any purpose, without the prior written permission of TMSS France. Copyright, intellectual, and all other proprietary rights in the content of this catalogue (including but not limited to audio, video, text, and photographs) rests with TMSS France, its subsidiaries, and other affiliated companies or its licensors. All rights in such content not expressly granted herein are reserved. No rights of any kind are licensed or assigned or shall otherwise pass to persons accessing this information.

As standards, specifications and design change from time to time, please ask for confirmation of the information given in this publication.

©2023, TMSS France, All Rights Reserved.

**TMSS France**  
35 rue Joseph Monier  
92500 Rueil-Malmaison - France

**TES ELECTRIC US, LLC**  
1875 Founders Dr.  
Kettering, OH 45420 - United States of America  
customer-support-NA@tesensors.com  
(833)-737-1405

September 2023 - V1.0

TESEBRO000025EN