

PRODUCTS CATALOGUE 2017

▶ NEXTYS

www.nextys.com

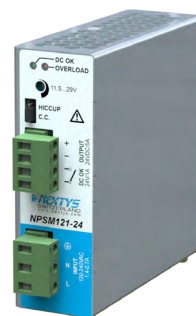

SWITZERLAND

Green products ...



... from a green country!

INDEX

Introduction			
About Us	2	Quality Approvals and Standards Compliance	4
NEW PRODUCTS OVERVIEW	3		
NEXT Generation Power Supplies			B
DIN Rail Power Supplies at a Glance ...	8		
Power Supplies - 20...80W, 1 PHASE, CLASS II INSULATION, GENERAL PURPOSE			C
NPSM20 (20W)	12	NPSM40 (40W)	14
NPSM30S (30W) - NEW	13	NPSM80 (80W)	15
Power Supplies - 85...480W, 1 PHASE, GENERAL PURPOSE			D
NPSM85 (85W)	18	NPSM480 (480W)	21
NPSM120 (120W)	19	NPSM501 (480W)	22
NPSM240 (240W)	20	NPSM121IP (120W) / NPSM241IP (240W) - NEW	23
Power Supplies - 120...960W, 1 PHASE, HIGH PERFORMANCE, ULTRACOMPACT			E
NPSM121 (120W)	26	NPSM241 (240W)	29
MEPS150 (150W) - NEW	27	NPSM481 (480W)	30
PSH150 (150W, 10kV Isolation Programmable) - NEW	28	NPSM962 (960W) - NEW	31
Power Supplies - 480...960W, 3 PHASES, COMPACT			F
NPST480 (480W)	34	NPST961 (960W)	37
NPST501 (480W)	35	NPST962 (960W) - NEW	38
NPST721 (720W)	36		
Power Supply - 2400W, 3 PHASES, MULTIPURPOSE, DIGITAL			G
NPS2400 (2400W)	40		
Power Supplies - 5...480W, 1/2/3 PHASES, WIDE INPUT RANGE, COMPACT			H
PSW5-5 (5W)	42	NPSW480 (480W)	46
NPSW25 (25W)	43	WEPS160 (160W)	47
NPSW120 (120W)	44	SBP200 (200W, 36...205Vdc Programmable Output)	48
NPSW240 (240W)	45	SBP200L (200W, 24...120Vdc Programmable Output) - NEW	49
DC/DC CONVERTERS (3...240W)			I
NDD3-1205 (3W) - NEW	52	NDD240 (240W)	54
NDD120 (120W)	53	NDW240 (240W, 5...55Vdc Programmable Output) - NEW	55
PROTECTION, BACK-UP AND REDUNDANCY SOLUTIONS			L
NEF210 (DC Overcurrent Protector / Static Switch) - NEW	58	BU150U (500W Short Time Buffer)	64
NISO-20 (800W, DC/DC Isolation Module) - NEW	59	NBP30 (Dual Voltage Battery Housing)	65
DCU20 (20A, High Performance DC-UPS)	60	NCP12 (12V Super Capacitors Module) - NEW	66
DCW20 (960W, Combo DC-UPS / DC-DC Converter) - NEW	61	OR20 (20A Active Redundancy Module)	67
NUPS12/24 (Basic Battery Charger / DC-UPS)	62	OR50 (50A Active Redundancy Module)	68
NCU120 (120W Basic SMPS / Charger / DC-UPS)	63		
BATTERY MONITORING SYSTEM (BMS)			M
BATTMASTER®	70		
MOUNTING BRACKETS			N
DIN-M (DIN Rail Clamp)	72	DINC35 (DIN Rail Clamp)	72
DIN-MS (DIN Rail Clamp)	72	WMP2 (Wall Mount Adapter)	72
DINC2 (DIN Rail Clamp)	72		
OTHER PRODUCTS			O
MODUS (USB to RS-485 Converter) - NEW	74	USW2A (5W Ultracompact In Wall USB Charger)	77
MBC2K (2000W Motor Brake Controller)	75	NPSR10-5 (10W Railway DC/DC Converter)	78
WM100-24 (100W Peak Flush Mount Power Supply)	76	CKMC5 (DIN Rail Ultracompact Motor Soft-start)	79

NOTES:

- 1) All shown parameters are typical. Unless otherwise specified they are measured at 25°C ambient temperature, nominal output voltage/current and one of the nominal input voltages.
- 2) Performance of the products may vary outside the nominal conditions, therefore it is guaranteed only within the specified nominal parameters.
- 3) In order to continuously improve our products we reserve the right to change the specifications without notice. For the last data sheets updates please consult www.nextys.com.
- 4) GLOSSARY: for various specific abbreviations please check the GLOSSARY at page 80 of this catalogue.

NEXTYS is a high tech Swiss company, founded in 1998.

We are a turn key, complete service provider for electronic products, from R&D to manufacturing and pre/post sales support.

We are located in the beautiful Tessin canton, an area well known for both natural beauties and strong presence of major industrial electronics companies, especially in the power and energy management field. Local universities and the neighborhood of the most industrialized area of Italy are other factors that contribute to our growth.

NEXTYS is focused on:

- **power electronics**
- **battery monitoring system (BATTMASTER®)**
- **custom designs**



The **DIN rail power supplies** are the field of excellence for NEXTYS.

We are one of the few companies with very broad offer in this segment. Up to date we delivered **>1.1 million power supplies** for industrial applications achieving an excellent quality level (**<850 ppm for claims in <2 years from manufacturing**).

We are proposing various power supplies with **AC (1/2/3 phases) or DC (up to 750Vdc)** input or both AC and DC inputs. All families have different models rated according to the output voltage (**5 to 205Vdc**). Our products are covering from **5W to 2400W** and include the newest technologies for high efficiency, high reliability and best cost/performance ratio.

We have pioneered some outstanding products as the **2400W/3 phases** input (unique on the market up to date), **1/2/3 phases and DC input Switch Mode Power Supplies (SMPS)**, first **DIN rail power supply with programmable output**.

Our recent achievements in the **back-up and redundancy segment** and the extension of **digital solutions** in high volume industrial power supplies increased our market visibility and customers' appreciation.

Our **POWERMASTER** free software provides excellent remote set-up and monitoring capabilities for many of our products. We have achieved expertise in special applications like naval, railway, harsh environments (e.g.: providing IP65 protection, approvals for Hazardous Location, etc.). Most of our products are **UL approved** (NEXTYS is an accepted lab for testing) or certified by other standards, according to the product's specific.

All our designs are based on:

- **continuous innovation** (we are pioneering new products with the concepts "Me First" and "Maximum Flexibility")
- **energy saving**
- **high reliability**
- **design to cost**

Wide choice of competencies, high professional level of the people involved, combined with the attractive cost/quality of our services boosted our growth.

Important partnerships with top service providers from the industrial and technological fields are a warranty for the quality we supply.

Flexibility, quick feedback, creative and innovative approaches are the solid basis of our company's culture, together with the traditional **Swiss quality**.

Our customers list includes both well-known brand name companies and medium-small sized businesses. You are welcome to be one of them!

**OUR CUSTOMERS SATISFACTION IS OUR MAIN GOAL
JUST GIVE US A TRY!**

We have extended our concept of flexibility and multiple integrated features by launching some new “ME FIRST” DIN rail products.

Within this catalogue you will find the market first **standard power supply with 10kV PRI/SEC isolation (PSH150)**, a **combined DC-UPS / DC-DC converter with programmable output (DCW20)**, a **DC Isolation Module (NISO20)**, a **programmable DC/DC converter (NDW240)**.

Most of the new products have a digital implementation and communication features that allow their easy integration within the system they are operated.

By continuing our path through innovation we are pleased to introduce the following products:

NPSM30S (30W) - SLIM 1 PHASE POWER SUPPLY.....Pag.13

NPSM121IP (120W) / **NPSM241IP** (240W) - IP65 1 PHASE POWER SUPPLY.....Pag.23

MEPS150 (150W) - ULTRACOMPACT 1 PHASE POWER SUPPLY.....Pag.27

PSH150 (150W) - 10KV ISOLATION PROGRAMMABLE POWER SUPPLY.....Pag.28

NPSM962 (960W) - ULTRACOMPACT 1 PHASE POWER SUPPLY.....Pag.31

NPST962 (960W) - ULTRACOMPACT 3 PHASES POWER SUPPLY.....Pag.38

SBP200L (200W) - 24...120Vdc PROGRAMMABLE OUTPUT POWER SUPPLY.....Pag.49

NDD3-1205 (3W) - COMPACT DC/DC CONVERTER.....Pag.52

NDW240 (240W) - 5...55Vdc PROGRAMMABLE OUTPUT DC/DC CONVERTER.....Pag.55

NEF210 - PROGRAMMABLE 2 CHANNELS DC OVERCURRENT PROTECTOR / STATIC SWITCH.....Pag.58

NISO-20 (800W) - DC/DC ISOLATION MODULE.....Pag.59

DCW20 (960W) - COMBO DC-UPS / DC-DC Converter.....Pag.61

NCP12 - 12V SUPER CAPACITORS MODULE.....Pag.66

MODUS - USB TO RS-485 CONVERTER.....Pag.74



Products bearing this logo are compliant to our free application **POWERMASTER** dedicated to remote monitoring, setup and firmware update for Windows and Android OS.



Products bearing this logo embed a CPU and related circuitry for power management and communication.



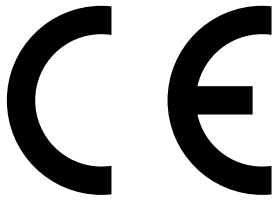

NEXTYS products are compliant to EU applicable standards that allow the CE marking.

All our products are CE marked.



Worldwide known safety standards are applied to most of our products.



Environmental compliance is assured by the compliance to the 2011/65/UE Directive, known as RoHS, which limits the use of specific dangerous materials in electric and electronics devices.



Registration, Evaluation and Authorisation of Chemicals

DISCLAIMER: the products included in this catalogue are not designed, intended or authorized for use as components in systems intended for surgical implant into the body, or other applications intended to support or sustain life, or for any other application in which the failure of the product could create a situation where personal injury, death or critical damages may occur.



▶ **NEXT** GENERATION POWER SUPPLIES

Power supplies are the heart of every electrical system application. Unsuitable devices can cause system breakdown and important subsequent costs. Modern power supplies must offer maximum efficiency, compact sizes and supply constant power under stressful conditions. Back-up and redundancy solutions will safeguard all power critical systems.

B



By deploying the latest technology, including digital solutions, our products reached top performance by:

✓ **COMPACTNESS**

50% volume savings vs. market average, small size without compromising in quality or reliability.

✓ **EFFICIENCY**

Decreased power consumption and reduced energy cost, achieving significant saving.

✓ **FLEXIBILITY**

Most of our products offer wide input voltage and extended output voltage range (5 to 205Vdc, within several models), to meet different requirements in one unit. We include multiple functions in one product, thus covering more needs and reducing the user's stock management costs.

✓ **RELIABILITY**

By implementing simple topologies and digital solutions we can guarantee the maximum safety for the system. Thanks to power boost by >50%, remote control, monitoring software, diagnosis tools and various protection circuitry, most of the critical operating conditions are well covered.

DIN Rail Power Supplies at a Glance ...

B



20...80W, 1 PHASE, CLASS II INSULATION, GENERAL PURPOSE

SMPS with 1 phase input (90...264V) aimed on cost saving (2 wires connection, compact, rugged plastic housing compliant with installation in standard cabinets). Output voltages range from 5 to 24Vdc (model dependent).

Applications: building automation and industrial



85...480W, 1 PHASE, GENERAL PURPOSE

SMPS with 1 phase input (90...264V) with output voltages range from 5 to 72Vdc (model dependent) are available in a compact size, with important overload capability.

Applications: industrial, energy management, telecom, harsh environments



120...960W, 1 PHASE, HIGH PERFORMANCE, ULTRACOMPACT

SMPS with 1 phase input (90...264V) with output voltages range from 12 to 72Vdc (model dependent). They have unrivalled performance.

Applications: demanding industrial, energy management, telecom, transportation



480...2400W, 3 PHASES, COMPACT

SMPS with 3 phases input (340...550Vac), with output voltages range from 12 to 170V (model dependent).

Applications: industrial, where compactness and high power are critical



5...480W, 1/2/3 PHASES, WIDE INPUT RANGE, COMPACT

SMPS with universal input (185...550Vac) with 1/2/3 phases wiring or DC (350...725Vdc) without any derating related to the input connection, with output voltages range from 12 to 72V (model dependent).

They can decrease considerably the material management costs.

Applications: industrial, renewable energy, elevators, harsh environments

... and More ...



3...240W, DC/DC CONVERTERS

DC/DC converters with wide range of input and output voltages. They fit those applications where the DC voltage conversion needs a compact and flexible solution.

Applications: industrial, transportation, telecom



PROTECTION, BACK-UP AND REDUNDANCY SOLUTIONS

They include versatile DC-UPS, battery chargers, battery packs and redundancy modules (ORing).

Applications: where power loss is critical



BATTERY MONITORING SYSTEM (BMS)

BATTMASTER® is an innovative high tech, compact battery monitoring system, based on wireless communication. Easy to install and operate, it is the first wireless BMS on the market.

Applications: UPS, energy management, telecom, industry



MOUNTING BRACKETS

These accessories are offered as complementary parts for various applications.

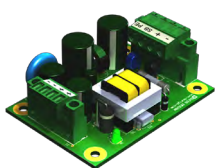

OTHER PRODUCTS

These products are of specific design and they cover various applications as railway, residential use, elevators, medical, motor control, etc.



THE IDEAL POWER SUPPLY FOR SMALL CABINETS

- ✓ Class II insulation. No grounding connection is needed (time and cost saving)
- ✓ Short circuit, overload and over temperature protection
- ✓ Suitable for application in SELV and PELV circuits
- ✓ High reliability
- ✓ Low standby power
- ✓ High overload capability
- ✓ Compact (slim - 22.5mm, 2 and 4 DIN modules with circuit breaker shape)

Applications:

- ✓ Industrial automation (e.g.: small loads, displays, PLCs)
- ✓ Residential & building automation
- ✓ Systems that fit into small remote panels

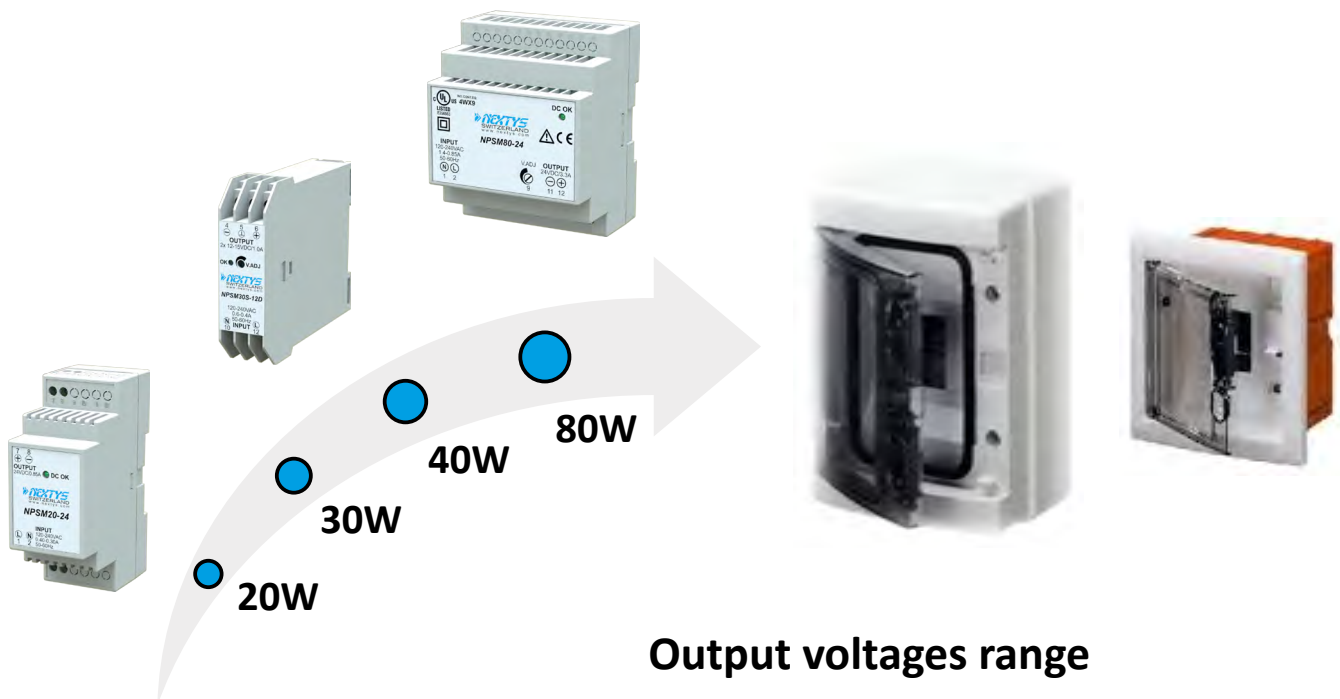

Output voltages range

Power (W)	Vdc (Out)				
	5...15	12	12...15	2x12...15	24
20					
30					
40					
80					

- High efficiency and compact size
- Plastic enclosure, circuit breaker shape
- Simplified wiring (no PE connection)
- Overload 170%
- High operating temperature with no derating

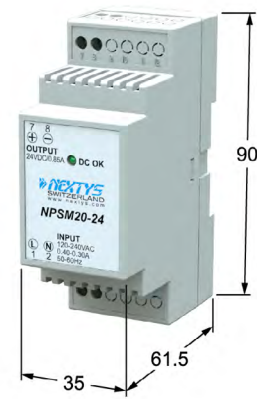

For reference only



TECHNICAL DATA

	NPSM20-12	NPSM20-24
OUTPUT DATA		
Rated voltage	12Vdc	24Vdc
Adj. output voltage range	12Vdc Fixed	24Vdc Fixed
Continuous current	1.65A	0.85A
Overload limit		
Vin = 120Vac	2.6A	1.3A
Vin = 240Vac	3.25A	1.7A
Load regulation	≤ 1%	
Ripple and noise	≤ 100mVpp	
Hold up time	≥ 5ms	
Protections	<ul style="list-style-type: none"> • Overload/short circuit: hiccup mode • Thermal protection • Output overvoltage 	
Status signals	DC OK - green LED	
Parallel connection	Possible for redundancy (with external ORing module)	
INPUT DATA		
Input AC rated voltage	Nominal: 120...240Vac (range 90...264Vac)	
Frequency	47...63Hz	
Input DC rated voltage	110...345Vdc	
Input AC rated current		
Vin = 120Vac	400mA	
Vin = 240Vac	300mA	
Input DC rated current		
Vin = 110Vdc	300mA	
Vin = 345Vdc	< 100mA	
Inrush peak current	≤ 50A	
Touch (leakage) current	≤ 0.2mA	
Internal protection fuse	Fuse 1AT (not user replaceable)	
Recommended external protection	MCB 6A C curve / SPD	
GENERAL DATA		
Efficiency	> 80%	
Dissipated power	< 6W	
Operating temperature	- 40°C...+ 70°C (UL certified up to 50°C)	
Derating	- 0.5W/°C over 50°C	
Lifetime expectancy	58'629h (6.6 years) at 25°C ambient full load	
Overvoltage category	III	
Pollution degree	2 (IEC60664-1)	
Input / output isolation	4.2kVdc	
Standards & Approvals	UL508 (certified), EN60950 (reference), CE marking	
EMC Standards	EN61000-6-2, EN61000-6-4	
Protection degree	IP20 (EN60529)	
Connection terminals	2.5mm ² , screw type header (24...12AWG)	
Case material	ABS, Flame retardant UL94 V-0	
Weight	0.1kg	
Size (W x H x D)	35 x 90 x 61.5mm	

- High efficiency and extremely compact size
- Ultra-slim plastic enclosure only 22.5mm
- Simplified wiring (no PE connection)
- Overload 130%
- High operating temperature with no derating

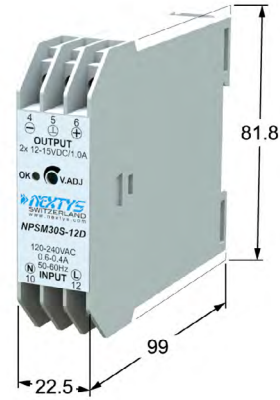

For reference only



TECHNICAL DATA

	NPSM30S-12	NPSM30S-12D	NPSM30S-24
OUTPUT DATA			
Rated voltage	12Vdc	2 x 12...15Vdc	24Vdc
Adj. output voltage range	10...15Vdc	2 x 12...15Vdc	22...28Vdc
Continuous current	1.5A @ 10Vdc 1A @ 15Vdc	1A	1.2A
Overload limit	2A @ 10Vdc 1.3A @ 15Vdc	1.5A @ 12Vdc 1.2A @ 15Vdc	1.5A
Load regulation		≤ 0.5%	
Ripple and noise		≤ 100mVpp	
Hold up time			
Vin = 120Vac		≥ 5ms	
Vin = 240Vac		≥ 25ms	
Protections	<ul style="list-style-type: none"> • Overload/short circuit: hiccup mode • Thermal protection • Output overvoltage 		
Status signals		DC OK - green LED	
Parallel connection		Possible for redundancy (with external ORing module)	
INPUT DATA			
Input AC rated voltage	Nominal: 120...240Vac (range 90...264Vac)		
Frequency	47...63Hz		
Input DC rated voltage	110...345Vdc		
Input AC rated current			
Vin = 120Vac	600mA		
Vin = 240Vac	400mA		
Input DC rated current			
Vin = 110Vdc	400mA		
Vin = 345Vdc	150mA		
Inrush peak current	≤ 55A		
Touch (leakage) current	≤ 0.3mA		
Internal protection fuse	Fuse 2AT (not user replaceable)		
Recommended external protection	Fuse 6AT or MCB 6A C curve / SPD		
GENERAL DATA			
Efficiency	> 82.5%	> 83%	> 87%
Dissipated power	< 3.1W	< 5W	< 4.5W
Operating temperature	- 40°C...+ 70°C		
Derating	No Derating		
Lifetime expectancy	121'731h (13.9 years) at 25°C ambient full load		
Overvoltage category	III		
Pollution degree	2 (IEC60664-1)		
Input / output isolation	4.2kVdc		
Standards & Approvals	UL508 (reference), EN60950 (reference), CE marking		
EMC Standards	EN61000-6-2, EN61000-6-3		
Protection degree	IP20 (EN60529)		
Connection terminals	2.5mm ² , screw type header (24...12AWG)		
Case material	ABS, Flame retardant UL94 V-0		
Weight	0.14kg		
Size (W x H x D)	22.5 x 99 x 81.8mm		

- High efficiency and compact size
- Plastic enclosure, circuit breaker shape
- Simplified wiring (no PE connection)
- Overload 150%
- Includes (5...15V) and (2 x 12...16V) models
- High operating temperature with no derating

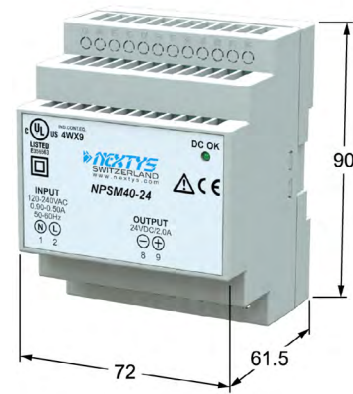

For reference only



TECHNICAL DATA

	NPSM40-515	NPSM40-12D	NPSM40-12	NPSM40-24
OUTPUT DATA				
Rated voltage	5...15Vdc	2 x 12...16Vdc	12...15Vdc	24Vdc
Adj. output voltage range	5...15Vdc	2 x 12...16Vdc	12...15Vdc	24Vdc Fixed
Continuous current	4A @ 5Vdc 2A @ 15Vdc	1A	3.5A @ 12Vdc 3A @ 15Vdc	2A
Overload limit	6.5A @ 5Vdc 4A @ 15Vdc	2.7...2.4A	6.5A @ 12Vdc 4.1A @ 15Vdc	3.5A
Load regulation	≤ 1%			
Ripple and noise	≤ 100mVpp			
Hold up time				
Vin = 120Vac	≥ 10ms			
Vin = 240Vac	≥ 50ms			
Protections	<ul style="list-style-type: none"> • Overload/short circuit: hiccup mode • Thermal protection • Output overvoltage 			
Status signals	DC OK - green LED			
Parallel connection	Possible for redundancy (with external ORing module)			
INPUT DATA				
Input AC rated voltage	Nominal: 120...240Vac (range 90...264Vac)			
Frequency	47...63Hz			
Input DC rated voltage	110...345Vdc			
Input AC rated current				
Vin = 120Vac	700mA		900mA	
Vin = 240Vac	400mA		500mA	
Input DC rated current				
Vin = 110Vdc	500mA		600mA	
Vin = 345Vdc	200mA		300mA	
Inrush peak current	≤ 75A			
Touch (leakage) current	≤ 0.25mA			
Internal protection fuse	Fuse 2AT (not user replaceable)			
Recommended external protection	MCB 6A C curve / SPD			
GENERAL DATA				
Efficiency	> 80%	> 83%	> 86%	> 85%
Dissipated power	< 8W	< 7W	< 8W	< 9W
Operating temperature	- 40°C...+ 70°C (UL certified up to 50°C)			
Derating	- 0.25W/°C over 50°C		- 0.35W/°C over 50°C	
Lifetime expectancy	62'251h (7.1 years) at 25°C ambient full load			
Overvoltage category	III			
Pollution degree	2 (IEC60664-1)			
Input / output isolation	4.2kVdc			
Standards & Approvals	UL508 (certified), EN60950 (reference), CE marking			
EMC Standards	EN61000-6-2, EN61000-6-4			
Protection degree	IP20 (EN60529)			
Connection terminals	2.5mm ² , screw type header (24...12AWG)			
Case material	ABS, Flame retardant UL94 V-0			
Weight	0.19kg			
Size (W x H x D)	72 x 90 x 61.5mm			

- High efficiency and compact size
- Plastic enclosure, circuit breaker shape
- Simplified wiring (no PE connection)
- Overload 150%
- High operating temperature with no derating

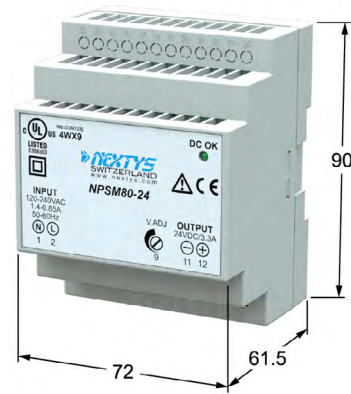

For reference only



TECHNICAL DATA

	NPSM80-12	NPSM80-24
OUTPUT DATA		
Rated voltage	12...15Vdc	24Vdc
Adj. output voltage range	12...15Vdc	23...28Vdc
Continuous current	6...5A	3.3A
Overload limit	7.5A @ 12Vdc 6.5A @ 15Vdc	4A
Load regulation	≤ 0.5%	≤ 1%
Ripple and noise	≤ 100mVpp	≤ 50mVpp
Hold up time		
Vin = 120Vac		≥ 10ms
Vin = 240Vac		≥ 30ms
Protections	<ul style="list-style-type: none"> • Overload/short circuit: hiccup mode • Thermal protection • Output overvoltage 	
Status signals	DC OK - green LED	
Parallel connection	Possible for redundancy (with external ORing module)	
INPUT DATA		
Input AC rated voltage	Nominal: 120...240Vac (range 90...264Vac)	
Frequency	47...63Hz	
Input DC rated voltage	110...345Vdc	
Input AC rated current		
Vin = 120Vac	1.5A	1.4A
Vin = 240Vac	0.85A	0.85A
Input DC rated current		
Vin = 110Vdc	1A	
Vin = 345Vdc	0.4A	
Inrush peak current	≤ 85A	
Touch (leakage) current	≤ 0.25mA	
Internal protection fuse	Fuse 2AT (not user replaceable)	
Recommended external protection	MCB 6A C curve / SPD	
GENERAL DATA		
Efficiency	> 86%	> 87%
Dissipated power	< 12.5W	< 12W
Operating temperature	- 40°C...+ 70°C (UL certified up to 50°C for NPSM80-12 and up to 55°C for NPSM80-24)	
Derating	- 1.2W/°C over 50°C	- 0.9W/°C over 55°C
Lifetime expectancy	51'136h (5.8 years) at 25°C ambient full load	
Overvoltage category	III	
Pollution degree	2 (IEC60664-1)	
Input / output isolation	4.2kVdc	
Standards & Approvals	UL508 (certified), EN60950 (reference), CE marking	
EMC Standards	EN61000-6-2, EN61000-6-4	
Protection degree	IP20 (EN60529)	
Connection terminals	2.5mm ² , screw type header (24...12AWG)	
Case material	ABS, Flame retardant UL94 V-0	
Weight	0.23kg	
Size (W x H x D)	72 x 90 x 61.5mm	



HIGH EFFICIENCY IN MINIMUM SIZE

- ✓ Suitable for worldwide applications: 90...264Vac and 110...345Vdc input
- ✓ High efficiency
- ✓ Multiple protections
- ✓ Pluggable terminals up to 240W
- ✓ Status LED
- ✓ Dry contacts for remote signalling
- ✓ Output voltage adjustment
- ✓ 72V output models available
- ✓ IP65 versions for harsh environments

Applications:

- ✓ Industrial automation
- ✓ Process control
- ✓ Heavy duty applications
- ✓ Building automation and general purpose

Output voltages range

Power (W)	Vdc (Out)				
	5	12	24	48	72
85					
120					
240					
480					

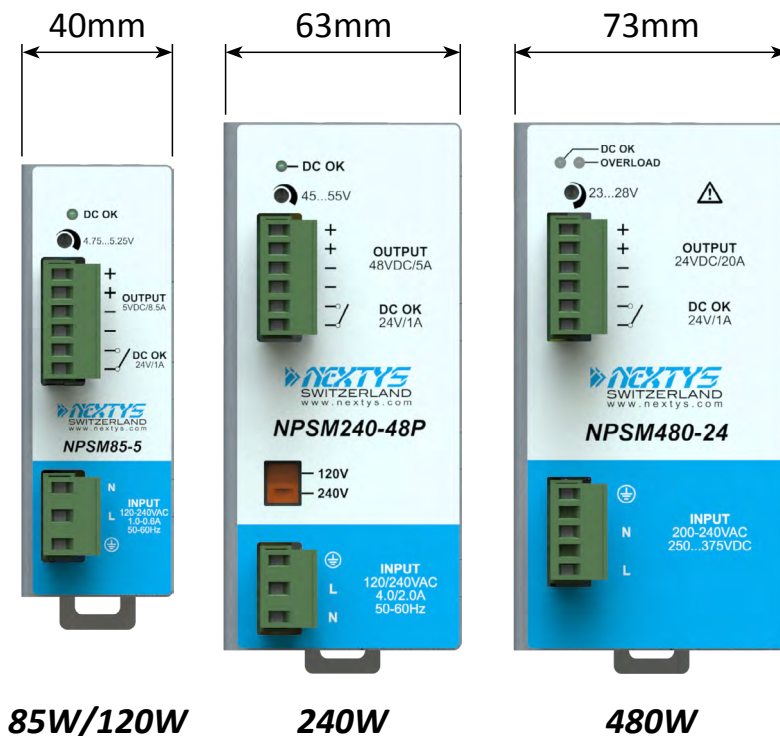

- ✓ Easy monitoring by “DC OK” LED and dry contact
- ✓ Pluggable connectors speed up system maintenance
- ✓ Wide output voltage range

- High efficiency and compact size
- Overload 150%
- Only 40mm width aluminum enclosure
- Up to 70°C operating temperature with no derating



For reference only



TECHNICAL DATA

	NPSM85-5	NPSM85-24	NPSM85-24P
OUTPUT DATA			
Rated voltage	5Vdc	24Vdc	
Adj. output voltage range	4.75...5.25Vdc	23...28Vdc	
Continuous current	8.5A	3.5A	
Overload limit	11A	5A	
Load regulation	≤ 3.5%	≤ 1%	≤ 2.5%
Ripple and noise	≤ 130mVpp		≤ 50mVpp
Hold up time			
Vin = 120Vac		≥ 15ms	
Vin = 240Vac		≥ 50ms	
Protections	<ul style="list-style-type: none"> • Overload/short circuit: hiccup mode • Thermal protection • Output overvoltage 		
Status signals	<ul style="list-style-type: none"> • DC OK - green LED • DC OK - dry contact (NO, 1A / 24Vdc) 		
Parallel connection	<ul style="list-style-type: none"> • Possible for redundancy (with external ORing module) • P (models) - include internal ORing circuit 		
INPUT DATA			
Input AC rated voltage	Nominal: 120...240Vac (range 90...264Vac)		
Frequency	47...63Hz		
Input DC rated voltage	110...345Vdc		
Input AC rated current			
Vin = 120Vac	1A	1.5A	
Vin = 240Vac	0.6A	0.9A	
Input DC rated current			
Vin = 110Vdc	0.7A	1.0A	
Vin = 345Vdc	0.3A	0.4A	
Inrush peak current	≤ 40A		
Touch (leakage) current	≤ 0.45mA		
Internal protection fuse	Fuse 2AT (not user replaceable)		
Recommended external protection	Fuse 6AT or MCB 6A C curve / SPD		
GENERAL DATA			
Efficiency	> 75%	> 88%	> 87%
Dissipated power	< 14.5W	< 11.5W	< 12.5W
Operating temperature	- 40°C...+ 70°C (UL certified up to 60°C)		
Derating	No derating up to 70°C		
Lifetime expectancy	138'640h (15.8 years) at 25°C ambient full load		
Overvoltage category	III		
Pollution degree	2 (IEC60664-1)		
Input / output isolation	4.2kVdc		
Input / ground isolation	2.2kVdc		
Output / ground isolation	0.75kVdc		
Standards & Approvals	UL508 (certified), EN60950 (reference), CE marking		
EMC Standards	EN61000-6-2, EN61000-6-4		
Protection degree	IP20 (EN60529)		
Connection terminals	2.5mm ² , screw type pluggable (24...12AWG)		
Case material	Aluminum		
Weight	0.45kg		
Size (W x H x D)	40 x 115 x 110mm		

- High efficiency and compact size
- Overload 150%
- Only 40mm width aluminum enclosure
- Up to 60°C operating temperature with no derating
- Excellent field reliability record



For reference only



TECHNICAL DATA

	NPSM120-12	NPSM120-24	NPSM120-24P	NPSM120-48P
OUTPUT DATA				
Rated voltage	12...15Vdc	24Vdc		48Vdc
Adj. output voltage range	12...15Vdc	23...28Vdc		45...55Vdc
Continuous current	7A	5A		2.5A
Overload limit	11...9.5A	7A		3.7A
Load regulation	≤ 2%	≤ 1%	≤ 2.5%	≤ 1.5%
Ripple and noise	≤ 120mVpp			
Hold up time	≤ 60mVpp			
Vin = 120Vac	≥ 10ms	≥ 20ms	≥ 10ms	≥ 10ms
Vin = 240Vac	≥ 60ms	≥ 50ms	≥ 50ms	≥ 50ms
Protections	<ul style="list-style-type: none"> • Overload/short circuit: hiccup mode • Thermal protection • Output overvoltage 			
Status signals	<ul style="list-style-type: none"> • DC OK - green LED • DC OK - dry contact (NO, 1A / 24Vdc) 			
Parallel connection	<ul style="list-style-type: none"> • Possible for redundancy (with external ORing module) • P (models) - include internal ORing circuit 			
INPUT DATA				
Input AC rated voltage	Nominal: 120...240Vac (range 90...264Vac)			
Frequency	47...63Hz			
Input DC rated voltage	110...345Vdc			
Input AC rated current				
Vin = 120Vac	1.9A	2.1A		
Vin = 240Vac	1.1A	1.2A		
Input DC rated current				
Vin = 110Vac	1.3A	1.4A		
Vin = 345Vac	0.5A	0.6A		
Inrush peak current	≤ 40A			
Touch (leakage) current	≤ 0.45mA			
Internal protection fuse	Fuse 3.15AT (not user replaceable)			
Recommended external protection	Fuse 6AT or MCB 6A C curve / SPD			
GENERAL DATA				
Efficiency	> 84%	> 87%	> 85%	> 86%
Dissipated power	< 20W	< 18W	< 21W	< 19W
Operating temperature	-40°C...+ 70°C			
Derating	(UL certified up to 60°C)			
Lifetime expectancy	- 2.4W/°C over 60°C			
Overvoltage category	106'880h (12.2 years) at 25°C ambient full load			
Pollution degree	III			
Input / output isolation	2 (IEC60664-1)			
Input / ground isolation	4.2kVdc			
Output / ground isolation	2.2kVdc			
Standards & Approvals	0.75kVdc			
EMC Standards	UL508 (certified), EN60950 (reference), CE marking			
Protection degree	EN61000-6-2, EN61000-6-4			
Connection terminals	IP20 (EN60529)			
Case material	2.5mm ² , screw type pluggable (24...12AWG)			
Weight	Aluminum			
Size (W x H x D)	0.45kg			
	40 x 115 x 110mm			

- High efficiency and compact size
- Overload 130%
- Only 63mm width aluminum enclosure
- Excellent field reliability record



For reference only



TECHNICAL DATA

	NPSM240-12	NPSM240-24	NPSM240-24P	NPSM240-48P	NPSM240-72P
OUTPUT DATA					
Rated voltage	12...15Vdc	24Vdc		48Vdc	72Vdc
Adj. output voltage range	12...15Vdc	23...28Vdc		45...55Vdc	72...85Vdc
Continuous current	16...14A	10A		5A	3.5A
Overload limit	19...16A	13.5A		6.8A	4.6A
Load regulation	≤ 1.5%	≤ 1%	≤ 2.5%	≤ 1.5%	
Ripple and noise	≤ 150mVpp		≤ 100mVpp		
Hold up time	≥ 70ms				
Protections	<ul style="list-style-type: none"> • Overload/short circuit: hiccup mode • Thermal protection • Output overvoltage 				
Status signals	<ul style="list-style-type: none"> • DC OK - green LED • DC OK - dry contact (NO, 1A / 24Vdc) 				
Parallel connection	<ul style="list-style-type: none"> • Possible for redundancy (with external ORing module) • P (models) - include internal ORing circuit 				
INPUT DATA					
Input AC rated voltage	Nominal: 120 / 240Vac (range 90...132 / 187...264Vac)				
Frequency	Settable with voltage input selector 47...63Hz				
Input DC rated voltage	270...345Vdc (only with 240V selected)				
Input AC rated current					
Vin = 120Vac	4A				
Vin = 240Vac	2A				
Input DC rated current					
Vin = 270Vdc	1.3A				
Vin = 345Vdc	1A				
Inrush peak current	≤ 40A				
Touch (leakage) current	≤ 0.8mA				
Internal protection fuse	Fuse 6.3AT (not user replaceable)				
Recommended external protection	Fuse 10AT or MCB 10A C curve / SPD				
GENERAL DATA					
Efficiency	> 84% ... > 86%	> 88%	> 86%	> 88%	
Dissipated power	< 36.5W ... < 34.5W	< 33W	< 39W	< 33W	< 34.5W
Operating temperature	- 40°C...+ 70°C (UL certified up to 50°C)				
Derating	- 5W/°C over 50°C				
Lifetime expectancy	77'894h (8.8 years) at 25°C ambient full load				
Overvoltage category	III				
Pollution degree	2 (IEC60664-1)				
Input / output isolation	4.2kVdc				
Input / ground isolation	2.2kVdc				
Output / ground isolation	0.75kVdc				
Standards & Approvals	UL508 (certified), EN60950 (reference), CE marking				
EMC Standards	EN61000-6-2, EN61000-6-4				
Protection degree	IP20 (EN60529)				
Connection terminals	2.5mm ² , screw type pluggable (24...12AWG)				
Case material	Aluminum				
Weight	0.75kg				
Size (W x H x D)	63 x 140 x 117mm				

- High efficiency and compact size
- Active PFC
- Excellent long lasting overvoltage withstand (up to 550Vac)
- Usable for broad range of industrial, telecom and renewable energy applications

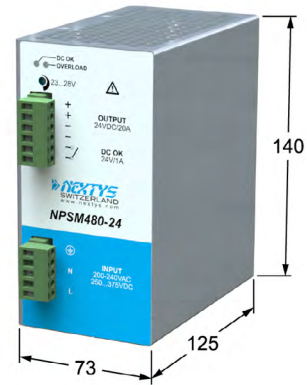

For reference only



TECHNICAL DATA

NPSM480-24

OUTPUT DATA

Rated voltage	24Vdc
Adj. output voltage range	23...28Vdc
Continuous current	20A
Overload limit	28A
Load regulation	≤ 1 %
Ripple and noise	≤ 50mVpp
Hold up time	≥ 50ms

Protections	<ul style="list-style-type: none"> • Overload/short circuit: hiccup mode • Thermal protection • Output overvoltage
Status signals	<ul style="list-style-type: none"> • DC OK - green LED • OVERLOAD - red LED • DC OK - dry contact (NO, 1A / 24Vdc)

Parallel connection Possible for redundancy (with external ORing module)

INPUT DATA

Input AC rated voltage	Nominal: 200...240Vac (range 187...264Vac)
Frequency	47...63Hz
Input DC rated voltage	250...375Vdc
Input AC rated current	
Vin = 200Vac	2.9A
Vin = 240Vac	2.5A
Input DC rated current	
Vin = 250Vdc	2.2A
Vin = 375Vdc	1.5A
Power factor correction	Active / > 0.9
Inrush peak current	≤ 40A
Touch (leakage) current	≤ 0.5mA
Internal protection fuse	None, external fuse must be provided
Recommended external protection	Fuse 6.3AT or MCB 6A C curve or 4A D curve / SPD

GENERAL DATA

Efficiency	> 91%
Dissipated power	< 48W
Operating temperature	- 40°C...+ 70°C (UL certified up to 45°C)
Derating	- 10W/°C over 45°C
Lifetime expectancy	65'496h (7.4 years) at 25°C ambient full load
Overvoltage category	III
Pollution degree	2 (IEC60664-1)
Input / output isolation	4.2kVdc
Input / ground isolation	2.2kVdc
Output / ground isolation	0.75kVdc
Standards & Approvals	UL508 (certified), EN60950 (reference), CE marking
EMC Standards	EN61000-3-2, EN61000-6-2, EN61000-6-4
Protection degree	IP20 (EN60529)
Connection terminals	2.5mm ² , screw type pluggable (24...12AWG)
Case material	Aluminum
Weight	1kg
Size (W x H x D)	73 x 140 x 125mm

- High efficiency and compact size
- Overload 150%
- Constant current or hiccup mode limitation, user settable
- Easy parallelable for power increase
- Natural convection cooling



For reference only



TECHNICAL DATA

	NPSM501-24	NPSM501-48	NPSM501-72
OUTPUT DATA			
Rated voltage	24Vdc	48Vdc	72Vdc
Adj. output voltage range	23...28Vdc	45...55Vdc	72...85Vdc
Continuous current	20A	10A	6.7A
Overload limit in constant current	22A	11A	7.5A
Overload limit in hiccup (max. 5s)	30A	15A	10A
Load regulation	≤ 1%		≤ 0.5%
Ripple and noise	≤ 100mVpp		≤ 200mVpp
Hold up time	≥ 35ms		
Protections	<ul style="list-style-type: none"> • Overload/short circuit: with constant current or hiccup mode (user settable) • Thermal protection • Output overvoltage 		
Status signals	<ul style="list-style-type: none"> • DC OK - green LED • ALARM - red LED • DC OK - dry contact (NO, 1A / 24Vdc) 		
Parallel connection	Possible for power or redundancy (with external ORing module)		
INPUT DATA			
Input AC rated voltage	Nominal: 120 / 240Vac (range 90...132 / 187...264Vac)		
Frequency	Settable with external voltage selector bridge 47...63Hz		
Input DC rated voltage	270...345Vdc (without external voltage selector bridge)		
Input AC rated current			
Vin = 120Vac		7.2A	
Vin = 240Vac		4.3A	
Input DC rated current			
Vin = 270Vdc		2.2A	
Vin = 345Vdc		1.9A	
Inrush peak current		≤ 35A	
Touch (leakage) current		≤ 1mA	
Internal protection fuse	None, external fuse must be provided		
Recommended external protection	Fuse 16AT or MCB 16A C curve / SPD		
GENERAL DATA			
Efficiency	> 91%	> 91.5%	> 92%
Dissipated power	< 48W	< 45W	< 42W
Operating temperature	- 40°C...+ 70°C (UL certified up to 45°C)		
Derating	- 7.2W/°C over 45°C		
Lifetime expectancy	64'000h (7.3 years) at 25°C ambient full load		
Overvoltage category	III		
Pollution degree	2 (IEC60664-1)		
Input / output isolation	4.2kVdc		
Input / ground isolation	2.2kVdc		
Output / ground isolation	0.75kVdc		
Standards & Approvals	UL508 (certified), EN60950 (reference), CE marking		
EMC Standards	EN61000-6-2, EN61000-6-4		
Protection degree	IP20 (EN60529)		
Connection terminals	1.5...6mm ² , screw type header (16...10AWG)		
Case material	Aluminum		
Weight	1.3kg		
Size (W x H x D)	80 x 127 x 137.5mm		

- IP65 design
- Suitable for harsh environments
- High efficiency and compact size
- Active PFC
- Overload 150%
- High operating temperature with no derating

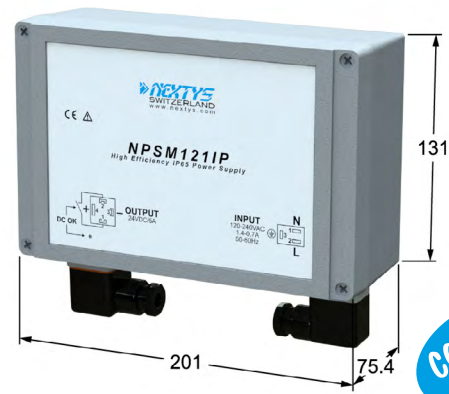

IP65



For reference only

D

TECHNICAL DATA

	NPSM1211P	NPSM2411P
OUTPUT DATA		
Rated voltage	24Vdc	
Adj. output voltage range	24Vdc fixed	
Continuous current	5A	10A
Overload limit	7.5A	11.5A
Load regulation	≤ 1%	
Ripple and noise	≤ 60mVpp	≤ 260mVpp
Hold up time	≥ 20ms	
Protections	<ul style="list-style-type: none"> • Overload/short circuit: hiccup mode • Thermal protection • Input undervoltage lockout • Output overvoltage 	
Status signals	<ul style="list-style-type: none"> • DC OK - green LED • DC OK - dry contact (NO, 1A / 24Vdc) 	
Parallel connection	Possible for redundancy (with external ORing module)	
INPUT DATA		
Input AC rated voltage	Nominal: 120...240Vac (range 90...264Vac)	
Frequency	47...63Hz	
Input DC rated voltage	110...345Vdc	
Input AC rated current		
Vin = 120Vac	1.4A	2.4A
Vin = 240Vac	0.7A	1.2A
Input DC rated current		
Vin = 110Vdc	1.4A	2.6A
Vin = 345Vdc	0.5A	0.9A
Power factor correction	Active / > 0.9	
Inrush peak current	≤ 45A	
Touch (leakage) current	≤ 0.6mA	
Internal protection fuse (not user replaceable)	Fuse 3.15AT	Fuse 6.3AT
Recommended external protection	Fuse 4AT or MCB 4A C curve / SPD	Fuse 10AT or MCB 10A C curve / SPD
GENERAL DATA		
Efficiency	> 90%	> 93%
Dissipated power	< 13.5W	< 19W
Operating temperature	- 35°C...+ 70°C	- 40°C...+ 70°C
Derating	-3W/°C over 50°C	
Lifetime expectancy	74'640h (8.5 years) at 25°C ambient full load	
Overvoltage category	III	
Pollution degree	2 (IEC60664-1)	
Input / output isolation	4.2kVdc	
Input / ground isolation	2.2kVdc	
Output / ground isolation	0.75kVdc	
Standards & Approvals	UL508 (reference), EN60950 (reference), CE marking	
EMC Standards	EN61000-3-2, EN61000-6-2, EN61000-6-4	
Protection degree	IP65	
Connection terminals	2.5mm ² , screw type DIN 43650 (24...12AWG)	
Case material	Aluminum (anodized)	
Weight	1.4kg	
Size (W x H x D)	188 x 120 x 78mm	

D



HIGH FLEXIBILITY FOR DEMANDING APPLICATIONS

- ✓ Smallest size in the market
- ✓ High power density
- ✓ High efficiency (up to 94%)
- ✓ PFC
- ✓ Wide output voltage adjust range: 11.5...28.5Vdc and 22...55Vdc (NPSM121 family)
- ✓ User settable current limitation algorithm (constant current or hiccup)
- ✓ Optimal "parallel for power" capability
- ✓ 150% overload
- ✓ Special model with 10kV isolation for energy management sector (PSH150)

Applications:

- ✓ Industrial machine control
- ✓ Process control
- ✓ Telecom
- ✓ Renewable energy
- ✓ High reliability applications

Output voltages range

Power (W)	Vdc (Out)					
	5...55	12	24	36	48	72
120						
150						
240						
480						
960						

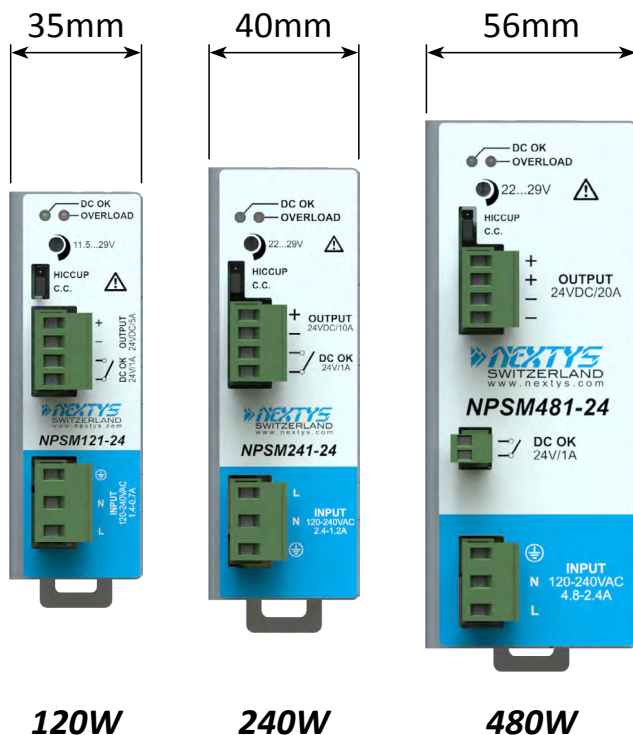

- ✓ First SMPS with versatile output configuration
- ✓ Maximum flexibility
- ✓ Low management cost
- ✓ Small Size

- High efficiency and extremely compact size
- Only 35mm width aluminum enclosure
- Active PFC
- Overload 150%
- Constant current or hiccup mode limitation, user settable
- Wide range of output voltage
- Up to 60°C operating temperature with no derating
- Easy parallelable for power increase

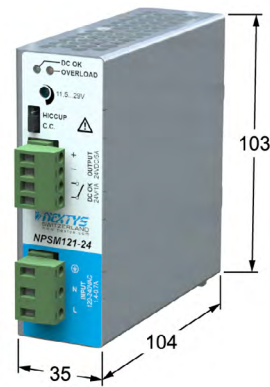

ULTRA COMPACT



For reference only

TECHNICAL DATA

	NPSM121-24	NPSM121-24P	NPSM121-48	NPSM121-48P
OUTPUT DATA				
Rated voltage	24Vdc		48Vdc	
Adj. output voltage range	11.5...29Vdc		23...56Vdc	
Continuous current	5A		2.5A	
Overload limit in constant current	7.5A		3.75A	
Overload limit in hiccup (max. 5s)	7.5A		3.75A	
Load regulation	≤ 1%	≤ 3%	≤ 0.5%	≤ 1.5%
Ripple and noise	≤ 60mVpp			
Hold up time				
Vin = 120Vac	≥ 20ms			
Vin = 240Vac	≥ 30ms			
Protections	<ul style="list-style-type: none"> • Overload/short circuit: with constant current or hiccup mode (user settable) • Thermal protection • Input undervoltage lockout • Output overvoltage 			
Status signals	<ul style="list-style-type: none"> • DC OK - green LED • OVERLOAD - red LED • DC OK - dry contact (NO, 1A / 24Vdc) 			
Parallel connection	<ul style="list-style-type: none"> • Possible for power or redundancy (with external ORing module) • P (models) - include internal ORing circuit 			
INPUT DATA				
Input AC rated voltage	Nominal: 120...240Vac (range 90...264Vac)			
Frequency	47...63Hz			
Input DC rated voltage	110...345Vdc			
Input AC rated current				
Vin = 120Vac	1.4A			
Vin = 240Vac	0.7A			
Input DC rated current				
Vin = 110Vdc	1.4A			
Vin = 345Vdc	0.5A			
Power factor correction	Active / > 0.9			
Inrush peak current	≤ 45A			
Touch (leakage) current	≤ 0.5mA			
Internal protection fuse	Fuse 3.15AT (not user replaceable)			
Recommended external protection	Fuse 4AT or MCB 4A C curve / SPD			
GENERAL DATA				
Efficiency	> 90%	> 89%	> 90%	> 89%
Dissipated power	< 13.5W	< 15W	< 13.5W	< 15W
Operating temperature	- 35°C...+ 70°C (UL certified up to 60°C)			
Derating	-1.2W/°C over 60°C			
Lifetime expectancy	74'640h (8.5 years) at 25°C ambient full load			
Overvoltage category	III			
Pollution degree	2 (IEC60664-1)			
Input / output isolation	4.2kVdc			
Input / ground isolation	2.2kVdc			
Output / ground isolation	0.75kVdc			
Standards & Approvals	UL508 (certified), EN60950 (reference), CE marking			
EMC Standards	EN61000-3-2, EN61000-6-2, EN61000-6-4			
Protection degree	IP20 (EN60529)			
Connection terminals	2.5mm ² , screw type pluggable (24...12AWG)			
Case material	Aluminum			
Weight	0.45kg			
Size (W x H x D)	35 x 103 x 104mm			

- High efficiency and extremely compact size
- Only 35mm width aluminum enclosure
- Active PFC
- Overload 125%
- High operating temperature with no derating

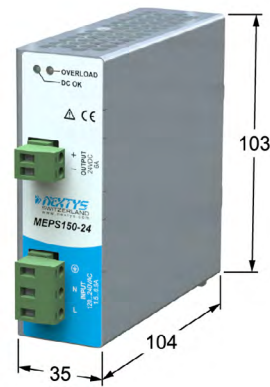

ULTRA
COMPACT

NEW



For reference only

TECHNICAL DATA

MEPS150-24

OUTPUT DATA

Rated voltage	24Vdc
Adj. output voltage range	24Vdc Fixed
Continuous current	6A
Overload limit	7.5A
Load regulation	≤ 1%
Ripple and noise	≤ 50mVpp
Hold up time	≥ 30ms

Protections	<ul style="list-style-type: none"> • Overload/short circuit: with constant current • Thermal protection • Input undervoltage lockout
Status signals	<ul style="list-style-type: none"> • DC OK - green LED • OVERLOAD - red LED

INPUT DATA

Input AC rated voltage	Nominal: 120...240Vac (range 90...264Vac)
Frequency	47...63Hz
Input DC rated voltage	110...345Vdc
Input AC rated current	
Vin = 120Vac	1.5A
Vin = 240Vac	0.8A
Input DC rated current	
Vin = 110Vdc	1.5A
Vin = 345Vdc	0.6A
Power factor correction	Active / > 0.9
Inrush peak current	≤ 30A
Touch (leakage) current	≤ 0.5mA
Internal protection fuse	Fuse 3.15AT (not user replaceable)
Recommended external protection	Fuse 4AT or MCB 4A C curve / SPD

GENERAL DATA

Efficiency	> 90.7%
Dissipated power	< 15W
Operating temperature	- 20°C...+ 70°C
Derating	- 4.5W/°C over 50°C
Lifetime expectancy	74'640h (8.5 years) at 25°C ambient full load
Overvoltage category	III
Pollution degree	2 (IEC60664-1)
Input / output isolation	4.2kVdc
Input / ground isolation	2.2kVdc
Output / ground isolation	0.75kVdc
Standards & Approvals	UL508 (pending), EN60950 (reference), CE marking
EMC Standards	EN61000-3-2, EN61000-6-2, EN61000-6-4
Protection degree	IP20 (EN60529)
Connection terminals	2.5mm ² , screw type pluggable (24...12AWG)
Case material	Aluminum
Weight	0.45kg
Size (W x H x D)	35 x 103 x 104mm

PSH150 - 150W, 10kV Isolation Programmable DIN Rail Power Supply

- Class II insulation (PE connection not required)
- 10kVac primary to secondary isolation (suitable for energy management applications)
- Wide output voltage range 5...55Vdc
- High efficiency and compact size
- Digital Power regulation
- User settable current limitation mode and thresholds
- Remote ON/OFF possible through INHIBIT input
- Modbus over USB and RS-485 interfaces for control and monitoring
- Can be paralleled for power or redundancy (integrated ORing circuitry)
- High operating temperature with derating
- Suitable for **POWERMASTER** software



For reference only



TECHNICAL DATA

PSH150

OUTPUT DATA

Rated voltage	5...55Vdc (1V resolution programmable)
Continuous current	12.0A @ 5...12Vdc - 6.0A @ 24Vdc - 3.0A @ 48Vdc - $V_{out} \times I_{out} = \text{Max } 150W$ for $V_{out} > 48Vdc$
Overload limit	12.5A to 3.0A (depending on V_{out})
Load regulation	$\leq 2\%$ @ 5Vdc - $\leq 1\%$ @ 12Vdc - $\leq 0.5\%$ @ $\geq 24Vdc$
Ripple and noise	$\leq 100mVpp$
Hold up time	$\geq 40ms$
Battery charger function	C.C./C.V. (setup via front panel or POWERMASTER application)
User interface	<ul style="list-style-type: none"> • 7 segment, 3 digits display • 3 programming keys • INHIBIT - isolated remote ON/OFF input, active for 5...30Vdc • 12V AUX - auxiliary 12Vdc / 100mA • Modbus over USB and RS-485 interfaces
Protections	<ul style="list-style-type: none"> • Overload and short circuit protections • Thermal protection • Input undervoltage lockout (UVLO), overvoltage protection (VDR) • Output overvoltage protection ($> 62Vdc$)
Status signals	<ul style="list-style-type: none"> • 3 status LEDs • DC OK - dry contact (SPDT, 1A / 24Vdc)
Parallel connection	Possible for power or redundancy (includes internal ORing circuit)

INPUT DATA

Input AC rated voltage	Nominal: 120...240Vac (range 90...277Vac)
Frequency	47...63Hz
Input DC rated voltage	110...400Vdc
Input AC rated current	
$V_{in} = 120Vac$	2.2A
$V_{in} = 240Vac$	1A
Input DC rated current	
$V_{in} = 110Vdc$	1.1A
$V_{in} = 400Vdc$	0.6A
Power factor correction	Active / > 0.9
Inrush peak current	$\leq 45A$
Touch (leakage) current	$\leq 0.1mA$
Internal protection fuse	Fuse 8AT (not user replaceable)
Recommended external protection	Fuse MCB 6A C curve / SPD

GENERAL DATA

Efficiency	$> 78\%$... $> 86\%$ (depending on V_{out} and V_{in})
Dissipated power	$< 16W$... $< 24W$ (depending on V_{out} and V_{in})
Operating temperature	$-40^{\circ}C$... $+70^{\circ}C$
Derating	Depending on V_{out} and V_{in} over $50^{\circ}C$ (see the online datasheet)
Lifetime expectancy	351'777h (40.1 years) at $25^{\circ}C$ ambient full load
Overvoltage category	IV
Pollution degree	2 (IEC60664-1)
Input / output isolation	10kVac
Standards & Approvals	UL508 (reference), EN60255-27 (reference), CE marking
EMC Standards	EN61000-3-2, EN61000-6-2, EN61000-6-4
Protection degree	IP20 (EN60529)

	IN/OUT	AUX	Interface
Connection terminals	2.5mm ² , screw type pluggable (24...12AWG)	Up to 0.5mm ² , Fast Pluggable type (20AWG) 7pins, 2.5mm pitch	<ul style="list-style-type: none"> • RS-485 through RJ45 Female • USB-B Type
Case material	PPO, Flame retardant UL94 V-0		
Weight	0.75kg		
Size (W x H x D)	179 x 100 x 64.5mm		

NPSM241 - 240W, 1 Phase, High Performance, Ultracompact DIN Rail Power Supply

- High efficiency and extremely compact size
- Only 40mm width aluminum enclosure
- Active PFC
- Overload 150%
- Constant current or hiccup mode limitation, user settable
- Up to 70°C operating temperature with no derating
- Wide range of output voltage
- Easy parallelable for power increase



For reference only



TECHNICAL DATA

	NPSM241-12 (P)	NPSM241-24 (P)	NPSM241-36 (P)	NPSM241-48P	NPSM241-72P
OUTPUT DATA					
Rated voltage	12Vdc	24Vdc	36Vdc	48Vdc	72Vdc
Adj. output voltage range	12...15Vdc	22...29Vdc	32...40Vdc	45...55Vdc	70...85Vdc
Continuous current	15A	10A	7A	5A	3.3A
Overload limit in constant current	17A	11A	7.5A	7A	4A
Overload limit in hiccup (max. 5s)	20A	15A	10A	8.5A	5.5A
Load regulation	≤ 2%	≤ 1%			
Ripple and noise	≤ 160mVpp	≤ 260mVpp	≤ 300mVpp	≤ 400mVpp	≤ 550mVpp
Hold up time	≥ 25ms	≥ 20ms	≥ 15ms	≥ 20ms	≥ 15ms
Protections	<ul style="list-style-type: none"> • Overload/short circuit: with constant current or hiccup mode (user settable) • Thermal protection • Input undervoltage lockout • Output overvoltage 				
Status signals	<ul style="list-style-type: none"> • DC OK - green LED • OVERLOAD - red LED • DC OK - dry contact (NO, 1A / 24Vdc) 				
Parallel connection	<ul style="list-style-type: none"> • Possible for power or redundancy (with external ORing module) • P (models) - include internal ORing circuit 				
INPUT DATA					
Input AC rated voltage	Nominal: 120...240Vac (range 90...264Vac)				
Frequency	47...63Hz				
Input DC rated voltage	110...345Vdc				
Input AC rated current					
Vin = 120Vac	2.4A		3.0A		2.4A
Vin = 240Vac	1.2A		1.5A		1.2A
Input DC rated current					
Vin = 110Vdc	2.5A	2.6A	2.5A		2.6A
Vin = 345Vdc	1.2A	0.9A	1.2A		0.9A
Power factor correction	Active / > 0.9				
Inrush peak current	≤ 50A				
Touch (leakage) current	≤ 0.6mA				
Internal protection fuse	Fuse 6.3AT (not user replaceable)				
Recommended external protection	Fuse 10AT or MCB 10A C curve / SPD				
GENERAL DATA					
Efficiency	> 90%	> 93%		> 93.5%	
Dissipated power	< 25W	< 19W		< 17W	
Operating temperature	- 40°C...+ 70°C (UL certified up to 70°C)				
Derating	No Derating				
Lifetime expectancy	221'288h (25.2 years) at 25°C ambient full load				
Overvoltage category	III				
Pollution degree	2 (IEC60664-1)				
Input / output isolation	4.2kVdc				
Input / ground isolation	2.2kVdc				
Output / ground isolation	0.75kVdc				
Standards & Approvals	UL508 (certified, not applicable for model -36 and 36P), EN60950 (reference), CE marking				
EMC Standards	EN61000-3-2, EN61000-6-2, EN61000-6-3				
Protection degree	IP20 (EN60529)				
Connection terminals	2.5mm ² , screw type pluggable (24...12AWG)				
Case material	Aluminum				
Weight	0.6kg				
Size (W x H x D)	40 x 115 x 110mm				

NPSM481 - 480W, 1 Phase, High Performance, Ultracompact DIN Rail Power Supply

- High efficiency and extremely compact size
- Only 56mm width aluminum enclosure
- Active PFC
- Overload 150%
- Constant current or hiccup mode limitation, user settable
- Up to 60°C operating temperature with no derating
- Wide range of output voltage
- Easy parallelable for power increase

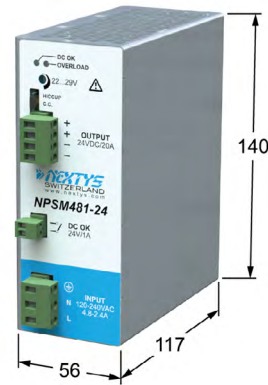

**ULTRA
COMPACT**

For reference only



TECHNICAL DATA

	NPSM481-24 (P)	NPSM481-36 (P)	NPSM481-48 (P)	NPSM481-72 (P)
OUTPUT DATA				
Rated voltage	24Vdc	36Vdc	48Vdc	72Vdc
Adj. output voltage range	22...29Vdc	32...40Vdc	45...55Vdc	70...85Vdc
Continuous current	20A	14A	10A	6.7A
Overload limit in constant current	21A	16A	12A	7A
Overload limit in hiccup (max. 5s)	30A	20A	17A	12A
Load regulation	≤ 1.5%	≤ 1%	≤ 0.5%	
Ripple and noise	≤ 150mVpp	≤ 200mVpp	≤ 50mVpp	
Hold up time	≥ 25ms	≥ 20ms	≥ 25ms	
Protections	<ul style="list-style-type: none"> • Overload/short circuit: with constant current or hiccup mode (user settable) • Thermal protection • Input undervoltage lockout • Output overvoltage 			
Status signals	<ul style="list-style-type: none"> • DC OK - green LED • OVERLOAD - red LED • DC OK - dry contact (NO, 1A / 24Vdc) 			
Parallel connection	<ul style="list-style-type: none"> • Possible for power or redundancy (with external ORing module) • P (models) - include internal ORing circuit 			
INPUT DATA				
Input AC rated voltage	Nominal: 120...240Vac (range 90...264Vac)			
Frequency	47...63Hz			
Input DC rated voltage	110...345Vdc			
Input AC rated current				
Vin = 120Vac	4.8A	5.5A		4.8A
Vin = 240Vac	2.4A	2.8A		2.4A
Input DC rated current				
Vin = 110Vdc	4.9A	5.3A		4.9A
Vin = 345Vdc	1.7A	1.9A		1.7A
Power factor correction	Active / > 0.9			
Inrush peak current	≤ 35A			
Touch (leakage) current	≤ 0.9mA			
Internal protection fuse	Fuse 8AT (not user replaceable)			
Recommended external protection	Fuse 10AT or MCB 10A C curve / SPD			
GENERAL DATA				
Efficiency	> 93%		> 94%	
Dissipated power	< 36.5W	< 32.5W		< 31W
Operating temperature	- 40°C...+ 70°C (UL certified up to 50°C at 120Vac or up to 60°C at 240Vac)			
Derating	- 7.6W/°C over 50°C at 120Vac - 7.2W/°C over 60°C at 240Vac			
Lifetime expectancy	167'953h (19.1 years) at 25°C ambient full load			
Overvoltage category	III			
Pollution degree	2 (IEC60664-1)			
Input / output isolation	4.2kVdc			
Input / ground isolation	2.2kVdc			
Output / ground isolation	0.75kVdc			
Standards & Approvals	UL508 (certified, not applicable for model -36 and 36P), EN60950 (reference), CE marking			
EMC Standards	EN61000-3-2, EN61000-6-2, EN61000-6-3			
Protection degree	IP20 (EN60529)			
Connection terminals	2.5mm ² , screw type pluggable (24...12AWG)			
Case material	Aluminum			
Weight	1.1kg			
Size (W x H x D)	56 x 140 x 117mm			

NPSM962 - 960W, 1 Phase, High Performance, Ultracompact DIN Rail Power Supply

- High efficiency and compact size
- Only 80mm width aluminum enclosure
- Active PFC
- Overload 150%
- Constant current or hiccup mode limitation, user settable
- Easy parallelable for power increase
- Natural convection cooling



ULTRA
COMPACT

COMING
SOON!

For reference only

TECHNICAL DATA

	NPSM962-12	NPSM962-24	NPSM962-48	NPSM962-72
OUTPUT DATA				
Rated voltage	12Vdc	24Vdc	48Vdc	72Vdc
Adj. output voltage range	12...15Vdc	22...29Vdc	45...55Vdc	70...85Vdc
Continuous current (@230Vac input)	40A		20A	13.3A
Overload limit in constant current	44A		22A	15A
Overload limit in hiccup (max. 5s)	60A		30A	20A
Load regulation	≤ 1%			
Ripple and noise	≤ 100mVpp			
Hold up time	≥ 20ms			
Protections	<ul style="list-style-type: none"> • Overload/short circuit: with constant current or hiccup mode (user settable) • Thermal protection • Output overvoltage 			
Status signals	<ul style="list-style-type: none"> • DC OK - green LED • ALARM - red LED • DC OK - dry contact (NO, 1A / 24Vdc) 			
Parallel connection	Possible for power or redundancy (with external ORing module)			
INPUT DATA				
Input AC rated voltage	Nominal: 120...240Vac (range 90...264Vac)			
Frequency	47...63Hz			
Input DC rated voltage	110...345Vdc			
Input AC rated current				
Vin = 120Vac	2.5A			5A
Vin = 240Vac	2.5A			5A
Input DC rated current				
Vin = 300Vdc	1.8A			3.5A
Inrush peak current	≤ 35A			
Touch (leakage) current	≤ 3mA			
Internal protection fuse	Fuse 16AT (not user replaceable)			
Recommended external protection	Fuse 10AT or MCB 10A C curve / SPD			
GENERAL DATA				
Efficiency	> 93%			> 94%
Dissipated power	< 36W			< 62W
Operating temperature	- 40°C...+ 70°C			
Derating	Automatic power derating for Vin < 180Vac			
Lifetime expectancy	70'080h (8 years) at 25°C ambient full load			
Overvoltage category	III			
Pollution degree	2 (IEC60664-1)			
Input / output isolation	4.2kVdc			
Input / ground isolation	2.2kVdc			
Output / ground isolation	0.75kVdc			
Standards & Approvals	UL508 (reference), EN60950 (reference), CE marking			
EMC Standards	EN61000-3-2, EN61000-6-1, EN61000-6-4			
Protection degree	IP20 (EN60529)			
Connection terminals	1.5...6mm ² , screw type (16...10AWG) for input 6...16mm ² , screw type (10...6 AWG) for output			
Case material	Aluminum			
Weight	1.3kg			
Size (W x H x D)	80 x 127 x 137.5mm			



HIGH POWER IN MINIMUM SIZE

- ✓ High efficiency
- ✓ Compactness
- ✓ Reliable starting of dynamic loads by POWER BOOST (+50% for 5s)
- ✓ Continuity of operation if one phase is lost (model dependent)
- ✓ User settable current limitation algorithm (constant current or hiccup)
- ✓ Optimal "parallel for power" capability
- ✓ Designed according to Machinery Directive 2006/42/EC
- ✓ Multiple protections
- ✓ Wide choice of output voltages

Applications:

- ✓ Industrial machine control
- ✓ Process control
- ✓ Conveyors
- ✓ DC back-up, battery charging
- ✓ Packing equipment
- ✓ Semiconductor manufacturing
- ✓ Renewable energy



Output voltages range

Power (W)	Vdc (Out)			
	12	24	48	72
480				
720				
960				

- High efficiency and compact size
- Active PFC
- Usable for applications where low line voltage is often present



For reference only



TECHNICAL DATA

NPST480-24

OUTPUT DATA

Rated voltage	24Vdc
Adj. output voltage range	23...28Vdc
Continuous current	20A
Overload limit	28A
Load regulation	≤ 1 %
Ripple and noise	≤ 50mVpp
Hold up time	≥ 20ms

Protections	<ul style="list-style-type: none"> • Overload/short circuit: hiccup mode • Thermal protection • Output overvoltage
-------------	---

Status signals	<ul style="list-style-type: none"> • DC OK - green LED • OVERLOAD - red LED • DC OK - dry contact (NO, 1A / 24Vdc)
----------------	--

Parallel connection Possible for redundancy (with external ORing module)

INPUT DATA

Input AC rated voltage	Nominal: 3 phases 400...500Vac (range 340...550Vac)
Frequency	47...63Hz
Input DC rated voltage	470...725Vdc
Input AC rated current	
Vin = 400Vac	1.3A
Vin = 500Vac	1.1A
Input DC rated current	
Vin = 470Vdc	1.2A
Vin = 725Vdc	0.8A
Power factor correction	Active / > 0.9
Inrush peak current	≤ 60A
Touch (leakage) current	≤ 0.5mA
Recommended external protection	Fuse 3 x 6.3AT or 3 x MCB 6A C curve or 3 x 4A D curve / SPD

GENERAL DATA

Efficiency	> 92%
Dissipated power	< 42W
Operating temperature	- 40°C...+ 70°C (UL certified up to 45°C)
Derating	- 10W/°C over 45°C
Lifetime expectancy	65'496h (7.4 years) at 25°C ambient full load
Overvoltage category	III
Pollution degree	2 (IEC60664-1)
Input / output isolation	4.2kVdc
Input / ground isolation	2.2kVdc
Output / ground isolation	0.75kVdc
Standards & Approvals	UL508 (certified), EN60950 (reference), CE marking
EMC Standards	EN61000-3-2, EN61000-6-2, EN61000-6-4
Protection degree	IP20 (EN60529)
Connection terminals	2.5mm ² , screw type pluggable (24...12AWG)
Case material	Aluminum
Weight	1kg
Size (W x H x D)	73 x 140 x 125mm

F

- High efficiency and compact size
- Overload 150%
- Constant current or hiccup mode limitation, user settable
- Easy parallelable for power increase
- Natural convection cooling
- 72V output model as standard



For reference only



TECHNICAL DATA

	NPST501-12	NPST501-24	NPST501-48	NPST501-72
OUTPUT DATA				
Rated voltage	12Vdc	24Vdc	48Vdc	72Vdc
Adj. output voltage range	12...15Vdc	23...28Vdc	45...55Vdc	72...85Vdc
Continuous current	40A	20A	10A	6.7A
Overload limit in constant current	44A	22A	11A	7.5A
Overload limit in hiccup (max. 5s)	60A	30A	15A	10A
Load regulation	≤ 2.5%	≤ 1%	≤ 0.5%	
Ripple and noise	≤ 150mVpp	≤ 100mVpp		
Hold up time	≥ 20ms			
Protections	<ul style="list-style-type: none"> • Overload/short circuit: with constant current or hiccup mode (user settable) • Thermal protection • Output overvoltage 			
Status signals	<ul style="list-style-type: none"> • DC OK - green LED • OVERLOAD - red LED • DC OK - dry contact (NO, 1A / 24Vdc) 			
Parallel connection	Possible for power or redundancy (with external ORing module)			
INPUT DATA				
Input AC rated voltage	Nominal: 3 phases, 400...500Vac (range 340...550Vac)			
Frequency	47...63Hz			
Input DC rated voltage	520...725Vdc			
Input AC rated current				
Vin = 400Vac	1.3A			
Vin = 500Vac	1.1A			
Input DC rated current				
Vin = 520Vdc	1.2A			
Vin = 725Vdc	0.9A			
Inrush peak current	≤ 50A			
Touch (leakage) current	≤ 0.15mA			
Internal protection fuse	None, external fuse must be provided			
Recommended external protection	Fuse 3 x 10AT or 3 x MCB 10A C curve / SPD			
GENERAL DATA				
Efficiency	> 87.5%	> 93.5%	> 94%	
Dissipated power	< 69W	< 34W	< 31W	
Operating temperature	- 40°C...+ 70°C (UL certified up to 50°C)			
Derating	- 4.5W/°C over 50°C			
Lifetime expectancy	63'200h (7.2 years) at 25°C ambient 75% load			
Overvoltage category	III			
Pollution degree	2 (IEC60664-1)			
Input / output isolation	4.2kVdc			
Input / ground isolation	2.2kVdc			
Output / ground isolation	0.75kVdc			
Standards & Approvals	UL508 (certified), EN60950 (reference), CE marking			
EMC Standards	EN61000-6-2, EN61000-6-4			
Protection degree	IP20 (EN60529)			
Connection terminals	1.5...6mm ² , screw type header (16...10AWG) 6...16mm ² , screw type header (10...6 AWG) for output on 12V model			
Case material	Aluminum			
Weight	1.3kg			
Size (W x H x D)	80 x 127 x 137.5mm			

- High efficiency and compact size
- Overload 150%
- Constant current or hiccup mode limitation, user settable
- Easy parallelable for power increase
- Up to 60°C operating temperature with no derating
- Low noise thermally regulated "long life" fan



For reference only



TECHNICAL DATA

	NPST721-24	NPST721-48
OUTPUT DATA		
Rated voltage	24Vdc	48Vdc
Adj. output voltage range	23...28Vdc	45...55Vdc
Continuous current	30A	15A
Overload limit in constant current	33A	16.5A
Overload limit in hiccup (max. 5s)	45A	22.5A
Load regulation	≤ 1%	≤ 0.5%
Ripple and noise	≤ 150mVpp	≤ 100mVpp
Hold up time	≥ 20ms	
Protections	<ul style="list-style-type: none"> • Overload/short circuit: with constant current or hiccup mode (user settable) • Thermal protection • Output overvoltage 	
Status signals	<ul style="list-style-type: none"> • DC OK - green LED • ALARM - red LED • DC OK - dry contact (NO, 1A / 24Vdc) 	
Parallel connection	Possible for power or redundancy (with external ORing module)	
INPUT DATA		
Input AC rated voltage	Nominal: 3 phases, 400...500Vac (range 340...550Vac)	
Frequency	47...63Hz	
Input DC rated voltage	520...725Vdc	
Input AC rated current		
Vin = 400Vac	1.9A	
Vin = 500Vac	1.7A	
Input DC rated current		
Vin = 520Vdc	1.7A	
Vin = 725Vdc	1.3A	
Inrush peak current	≤ 50A	
Touch (leakage) current	≤ 0.1mA	
Internal protection fuse	None, external fuse must be provided	
Recommended external protection	Fuse 3 x 10AT or 3 x MCB 10A C curve / SPD	
GENERAL DATA		
Efficiency	> 91%	> 93%
Dissipated power	< 72W	< 55W
Operating temperature	- 40°C...+ 70°C (UL certified up to 60°C)	
Derating	- 16W/°C over 60°C	
Lifetime expectancy	63'200h (7.2 years) at 25°C ambient 75% load	
Overvoltage category	III	
Pollution degree	2 (IEC60664-1)	
Input / output isolation	4.2kVdc	
Input / ground isolation	2.2kVdc	
Output / ground isolation	0.75kVdc	
Standards & Approvals	UL508 (certified), EN60950 (reference), CE marking	
EMC Standards	EN61000-6-2, EN61000-6-4	
Protection degree	IP20 (EN60529)	
Connection terminals	1.5...6mm ² , screw type (16...10AWG)	
Case material	Aluminum	
Weight	1.3kg	
Size (W x H x D)	80 x 127 x 137.5mm	

F

- High efficiency and compact size
- Overload 150%
- Constant current or hiccup mode limitation, user settable
- Easy parallelable for power increase
- High operating temperature with no derating
- Low noise thermally regulated "long life" fan
- 72V output model as standard

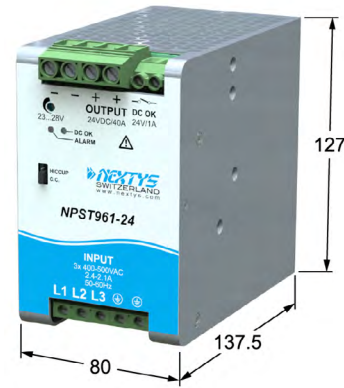

For reference only

TECHNICAL DATA

	NPST961-24	NPST961-48	NPST961-72
OUTPUT DATA			
Rated voltage	24Vdc	48Vdc	72Vdc
Adj. output voltage range	23...28Vdc	45...55Vdc	72...85Vdc
Continuous current	40A	20A	13.3A
Overload limit in constant current	44A	22A	15A
Overload limit in hiccup (max. 5s)	60A	30A	20A
Load regulation	≤ 1%	≤ 0.5%	
Ripple and noise	≤ 100mVpp		
Hold up time	≥ 15ms		
Protections	<ul style="list-style-type: none"> • Overload/short circuit: with constant current or hiccup mode (user settable) • Thermal protection • Output overvoltage 		
Status signals	<ul style="list-style-type: none"> • DC OK - green LED • ALARM - red LED • DC OK - dry contact (NO, 1A / 24Vdc) 		
Parallel connection	Possible for power or redundancy (with external ORing module)		
INPUT DATA			
Input AC rated voltage	Nominal: 3 phases, 400...500Vac (range 340...550Vac)		
Frequency	47...63Hz		
Input DC rated voltage	520...725Vdc		
Input AC rated current			
Vin = 400Vac	2.4A		
Vin = 500Vac	2.1A		
Input DC rated current			
Vin = 520Vdc	2.2A		
Vin = 725Vdc	1.7A		
Inrush peak current	≤ 50A		
Touch (leakage) current	≤ 0.1mA		
Internal protection fuse	None, external fuse must be provided		
Recommended external protection	Fuse 3 x 10AT or 3 x MCB 10A C curve / SPD		
GENERAL DATA			
Efficiency	> 90.5%	> 92.5%	> 93%
Dissipated power	< 101W	< 78W	< 73W
Operating temperature	- 40°C...+ 70°C (UL certified up to 45°C)		
Derating	- 15W/°C over 45°C		
Lifetime expectancy	63'200h (7.2 years) at 25°C ambient 75% load		
Overvoltage category	III		
Pollution degree	2 (IEC60664-1)		
Input / output isolation	4.2kVdc		
Input / ground isolation	2.2kVdc		
Output / ground isolation	0.75kVdc		
Standards & Approvals	UL508 (certified), EN60950 (reference), CE marking		
EMC Standards	EN61000-6-2, EN61000-6-4		
Protection degree	IP20 (EN60529)		
Connection terminals	1.5...6mm ² , screw type (16...10AWG) 6...16mm ² , screw type (10...6 AWG) for output on 24V model		
Case material	Aluminum		
Weight	1.3kg		
Size (W x H x D)	80 x 127 x 137.5mm		

- High efficiency and compact size
- Only 80mm width aluminum enclosure
- Active PFC
- Overload 150%
- Constant current or hiccup mode limitation, user settable
- Easy parallelable for power increase
- Natural convection cooling

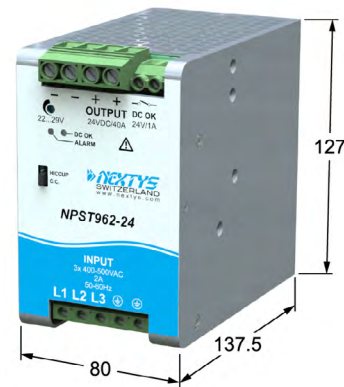

COMING SOON!



For reference only

TECHNICAL DATA

	NPST962-12	NPST962-24	NPST962-48	NPST962-72
OUTPUT DATA				
Rated voltage	12Vdc	24Vdc	48Vdc	72Vdc
Adj. output voltage range	12...15Vdc	22...29Vdc	45...55Vdc	70...85Vdc
Continuous current	40A		20A	13.3A
Overload limit in constant current	44A		22A	15A
Overload limit in hiccup (max. 5s)	60A		30A	20A
Load regulation	≤ 1%			
Ripple and noise	≤ 100mVpp			
Hold up time	≥ 20ms			
Protections	<ul style="list-style-type: none"> • Overload/short circuit: with constant current or hiccup mode (user settable) • Thermal protection • Output overvoltage 			
Status signals	<ul style="list-style-type: none"> • DC OK - green LED • ALARM - red LED • DC OK - dry contact (NO, 1A / 24Vdc) 			
Parallel connection	Possible for power or redundancy (with external ORing module)			
INPUT DATA				
Input AC rated voltage	Nominal: 3 phases, 400...500Vac (range 340...550Vac)			
Frequency	47...63Hz			
Input DC rated voltage	520...725Vdc			
Input AC rated current				
Vin = 400Vac	0.9A			1.7A
Vin = 500Vac	0.7A			1.3A
Input DC rated current				
Vin = 600Vdc	1A			2A
Inrush peak current	≤ 15A			
Touch (leakage) current	≤ 3mA			
Internal protection fuse	None, external fuse must be provided			
Recommended external protection	Fuse 3 x 10AT or 3 x MCB 10A C curve / SPD			
GENERAL DATA				
Efficiency	> 93%			> 94%
Dissipated power	< 36W			< 62W
Operating temperature	- 40°C...+ 70°C			
Derating	Automatic power derating for 2 phases operation			
Lifetime expectancy	70'080h (8 years) at 25°C ambient full load			
Overvoltage category	III			
Pollution degree	2 (IEC60664-1)			
Input / output isolation	4.2kVdc			
Input / ground isolation	2.2kVdc			
Output / ground isolation	0.75kVdc			
Standards & Approvals	UL508 (reference), EN60950 (reference), CE marking			
EMC Standards	EN61000-3-2, EN61000-6-1, EN61000-6-4			
Protection degree	IP20 (EN60529)			
Connection terminals	1.5...6mm ² , screw type (16...10AWG) for input 6...16mm ² , screw type (10...6 AWG) for output			
Case material	Aluminum			
Weight	1.3kg			
Size (W x H x D)	80 x 127 x 137.5mm			

F

MORE THAN A POWER SUPPLY

- ✓ World first 3 phases 2400W DIN rail SMPS
- ✓ Active PFC
- ✓ CPU control, LCD display, user friendly interface
- ✓ Maximum flexibility: can be used as battery charger for all chemistries, can be paralleled, can be set with various output limiting algorithms
- ✓ Remote measuring and control through USB (communication module included)
- ✓ Remote maintenance and diagnosis tools (**POWERMASTER** software)

Applications:

- ✓ Industrial machine control
- ✓ Process control
- ✓ Conveyors, material handling
- ✓ DC motor supply
- ✓ Semiconductor manufacturing
- ✓ Renewable energy
- ✓ Battery charger
- ✓ Back-up applications



- ✓ Wide output voltage range: 12...175V (model dependent)
- ✓ User friendly interface
- ✓ Saves management cost
- ✓ Can be integrated in complex automated systems

NPS2400 - 2400W, 3 Phases, Multipurpose, Digital DIN Rail Power Supply

- High efficiency and compact size
- Active PFC
- Overload 150% (3600W peak!)
- Active input surge suppression circuit for improved reliability
- CPU control allows flexibility and multiple programmable features
- Battery charger function included
- Thermally regulated "long life" fan for optimal cooling in harsh operating conditions
- Wide output voltages range
- Operation on 2 phases possible with power derating
- Suitable for **POWERMASTER** software

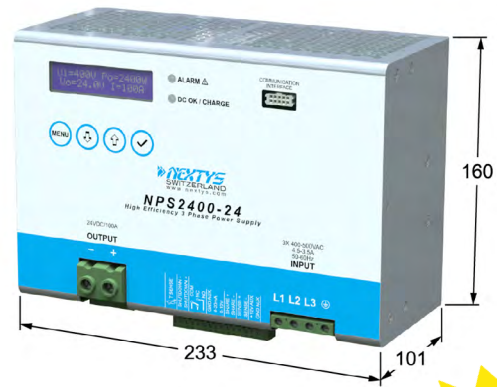

For reference only



TECHNICAL DATA

	NPS2400-24	NPS2400-48	NPS2400-72	NPS2400-170
OUTPUT DATA				
Rated voltage	24Vdc	48Vdc	72Vdc	170Vdc
Adj. output voltage range	11.9...29Vdc	23...56Vdc	50...87Vdc	85...175Vdc
Continuous current	100A	50A	33A	14A
Overload limit in constant current	100A	50A	33A	14A
Overload limit in hiccup (max. 5s)	150A	75A	50A	21A
Load regulation	≤ 1% with Remote Sense active and at Vout nom.			
Ripple and noise	≤ 400mVpp			
Hold up time	≥ 10ms			
Protections	<ul style="list-style-type: none"> • Overload (with user settable threshold) • Short circuit 		<ul style="list-style-type: none"> • Thermal protection • Output overvoltage 	
Status signals	<ul style="list-style-type: none"> • DC OK / CHARGE - green LED • ALARM - red LED 		<ul style="list-style-type: none"> • Alphanumeric LCD display • Dry contact (SPDT, 1A / 24Vdc) 	
User interface	<ul style="list-style-type: none"> • LCD with 4 keys • 0...10V voltage and 4...20mA current output for output current 0...100% In • Auxiliary 12V / 100mA isolated power supply • Load voltage sense 		<ul style="list-style-type: none"> • Optoisolated remote shut down input • USB communication interface via communication module (COMM-BOX) • Optional: remote temperature sensor for battery charging (WNTC-2MT) 	
Operating modes	<ul style="list-style-type: none"> • Overboost: allows 150% output power for 5sec, then off for 10sec. • Constant current: adjustable 10...100% load • Battery charger: for lead acid, nickel and lithium batteries 			
Parallel connection	Possible for power or redundancy (includes internal ORing circuit)			
INPUT DATA				
Input AC rated voltage	Nominal: 2/3 phases, 400...500Vac (range 340...550Vac)			
Frequency	47...63Hz			
Input DC rated voltage	520...725Vdc			
Input AC rated current				
Vin = 400Vac	4.5A			
Vin = 500Vac	3.5A			
Input DC rated current				
Vin = 520Vdc	5.2A			
Vin = 725Vdc	3.8A			
Power factor correction	Active / > 0.9			
Inrush peak current	≤ 10A active Inrush current limiter			
Touch (leakage) current	≤ 0.6mA			
Recommended external protection	Fuse 3 x 10AT or 3 x MCB 10A C curve / SPD			
GENERAL DATA				
Efficiency	> 92%		> 93%	> 92%
Dissipated power	< 200W		< 180W	< 200W
Operating temperature	- 40°C...+ 70°C (UL certified up to 50°C)			
Derating	- 60W/°C over 50°C			
Lifetime expectancy	Automatic power derating (1200W) for 2 phases operation			
Overvoltage category	458'253h (52.3 years) at 25°C ambient full Load			
Pollution degree	III			
Isolation	2 (IEC60664-1)			
Standards & Approvals	Input / output: 4.2kVdc - Input / ground: 2.2kVdc - Output / ground: 0.75kVdc			
EMC Standards	UL508 (certified), EN60950 (reference), CE marking			
Protection degree	EN61000-3-2, EN61000-6-2, EN61000-6-4			
Connection terminals input	IP20 (EN60529)			
Connection terminals output	1.5...6mm ² , screw type header (16...10AWG)			
Connection terminals auxiliary	Up to 35mm ² , screw type header (2AWG)			
Case material	1.5mm ² , screw type pluggable 16 pin (16AWG)			
Weight	Aluminum			
Size (W x H x D)	2.8kg			
	233 x 160 x 101mm			

G

TOP FLEXIBILITY IN PREMIUM SIZE

- ✓ Allow any input feed by 1, 2 or 3 phases wiring, without any derating
- ✓ Wide DC input voltage possible
- ✓ High efficiency
- ✓ Compact size
- ✓ Boost power (+ 50%) available for 5 seconds ensuring load safety and reliability
- ✓ Adjustable output voltage
- ✓ Robust input circuitry for withstanding harsh mains conditions
- ✓ Short circuit, overload, over temperature, input and output overvoltage protections

Applications:

- ✓ Industrial machine control
- ✓ Process control
- ✓ Conveyors, material handling
- ✓ Renewable energy
- ✓ Back-up applications

Output voltages range

Power (W)	Vdc (Out)							
	5	12	24	26	48	72	24...120	36...205
5								
25								
120								
160								
200								
240								
480								

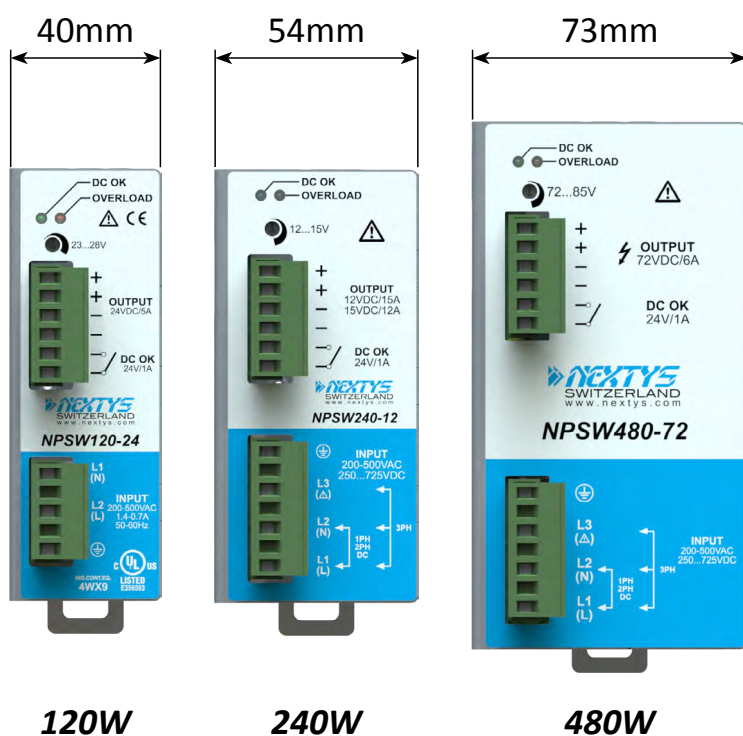

- ✓ 1, 2 & 3 phases input for TOP flexibility
- ✓ Easy stock management
- ✓ Easy maintenance planning
- ✓ Compact size allow minimal size of the control cabinets

- Miniature SMPS module for PCB
- 1, 2 or 3 phases input AC 110...500Vac
- Wide DC input range 150...700Vdc
- Aimed to be used as a unique module for powering various systems with different primary supply needs
- Potted
- Low cost

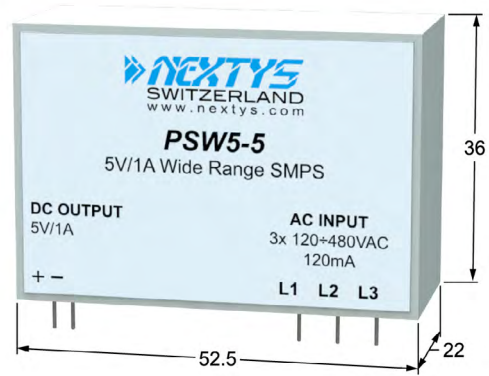

For reference only

TECHNICAL DATA

PSW5-5	
OUTPUT DATA	
Rated voltage	5Vdc
Adj. output voltage range	5Vdc Fixed
Continuous current	1A
Overload limit	1.25A
Load regulation	≤ 1%
Ripple and noise	≤ 100mVpp
Hold up time	≥ 20ms
Protections	<ul style="list-style-type: none"> • Hiccup at the overload limit with auto reset • Thermal protection
INPUT DATA	
Input AC rated voltage	Nominal: 1/2/3 phases, 120...480Vac (range 110...500Vac)
Frequency	47...63Hz
Input DC rated voltage	150...700Vdc
Input AC rated current	≤ 120mA
Input DC rated current	
Vin = 150Vdc	≤ 60mA
Vin = 700Vdc	≤ 20mA
Inrush peak current	≤ 30A
Touch (leakage) current	≤ 250µA
Internal protection fuse	Fuse Resistor on each line (not user replaceable)
Recommended external protection	3 x 0.315AT / 500V or other suitable rated devices / SPD
GENERAL DATA	
Efficiency	> 70%
Dissipated power	< 300mW
Operating temperature	- 25°C...+ 70°C
Derating	- 0.03W/°C over 65°C
Overvoltage category	III
Pollution degree	2 (IEC60664-1)
Input / output isolation	4.2kVdc
Standards & Approvals	UL508 (reference), EN60950 (reference), CE marking
EMC Standards	EN61000-6-2, EN61000-6-4
Protection degree	IP20 (EN60529)
Connection terminals	In line pins 3 x raster 5.08mm for input In line pins 2 x raster 2.54mm for output
Case material	ABS, Potted
Weight	60g
Size (W x H x D)	52.5 x 36 x 22mm

H

- High efficiency and extremely compact size
- 1 or 2 phases AC (90...550Vac) or DC (150...725Vdc) input
- Plastic enclosure, circuit breaker shape
- Class II insulation (simplified wiring)
- Overload 130%
- Up to 70°C operating temperature with derating
- Ideal for applications with harsh mains conditions
- Compliant to renewable energy systems and high voltage DC Bus

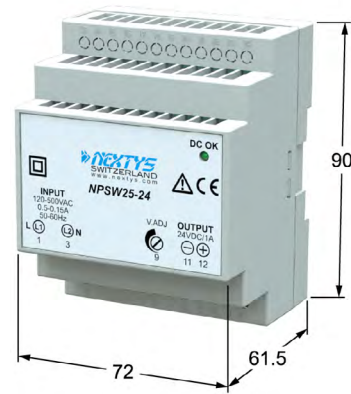

For reference only



TECHNICAL DATA

NPSW25-24	
OUTPUT DATA	
Rated voltage	24Vdc
Adj. output voltage range	23...28Vdc
Continuous current	1A
Overload limit	
Vin = 120Vac 1Ph	1.35A
Vin = 240Vac 1Ph	1.5A
Vin = 400Vac 2Ph	1.35A
Vin = 500Vac 2Ph	1.3A
Load regulation	≤ 0.5%
Ripple and noise	≤ 50mVpp
Hold up time	
Vin = 240Vac 1Ph	≥ 35ms
Vin = 500Vac 2Ph	≥ 180ms
Protections	<ul style="list-style-type: none"> • Overload/short circuit: hiccup mode • Thermal protection • Output overvoltage
Status signals	DC OK - green LED
Parallel connection	Possible for redundancy (with external ORing module)
INPUT DATA	
Input AC rated voltage	Nominal: 1/2 phases, 120...500Vac (range 90...550Vac)
Frequency	47...63Hz
Input DC rated voltage	150...725Vdc
Input AC rated current	
Vin = 120Vac 1Ph	0.5A
Vin = 500Vac 2Ph	0.15A
Input DC rated current	
Vin = 150Vdc	0.3A
Vin = 725Vdc	< 0.1A
Inrush peak current	≤ 20A
Touch (leakage) current	≤ 0.2mA
Internal protection fuse	None, external fuse must be provided
Recommended external protection	MCB 2A C curve / SPD
GENERAL DATA	
Efficiency	> 83%
Dissipated power	< 4.9W
Operating temperature	- 40°C...+ 70°C
Derating	Depending on load current and input voltage (see the online datasheet)
Lifetime expectancy	179'477h (20.4 years) at 25°C ambient full load
Overvoltage category	III
Pollution degree	2 (IEC60664-1)
Input / output isolation	4.2kVdc
Standards & Approvals	UL508 (reference), EN60950 (reference), CE marking
EMC Standards	EN61000-6-2, EN61000-6-3
Protection degree	IP20 (EN60529)
Connection terminals	2.5mm ² , screw type header (24...12AWG)
Case material	ABS, Flame retardant UL94 V-0
Weight	0.17kg
Size (W x H x D)	72 x 90 x 61.5mm

H

NPSW120 - 120W, 1/2 Phases, Wide Input Range, Compact DIN Rail Power Supply

- High efficiency and compact size, only 40mm width
- 1 or 2 phases input AC 187...550Vac
- Wide DC input range 250...725Vdc
- Overload 150%
- Excellent field reliability record
- Usable for broad range of industrial, telecom and renewable energy applications

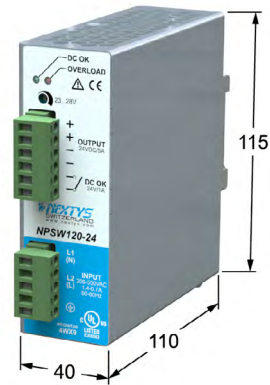

TECHNICAL DATA

	NPSW120-12	NPSW120-24	NPSW120-48P
OUTPUT DATA			
Rated voltage	12...15Vdc	24Vdc	48Vdc
Adj. output voltage range	12...15Vdc	23...28Vdc	45...55Vdc
Continuous current	8...7A	5A	2.5A
Overload limit (30s)	10A	7.5A	3.75A
Load regulation		≤ 1 %	
Ripple and noise		≤ 110mVpp	
Hold up time			
V _{in} = 240Vac		≥ 17ms	
V _{in} = 400Vac		≥ 60ms	
Protections	<ul style="list-style-type: none"> • Overload/short circuit: hiccup • Thermal protection • Output overvoltage 		
Status signals	<ul style="list-style-type: none"> • DC OK - green LED • OVERLOAD - red LED • DC OK - dry contact (NO, 1A / 24Vdc) 		
Parallel connection	<ul style="list-style-type: none"> • Possible for redundancy (with external ORing module) • P (models) - include internal ORing circuit 		
INPUT DATA			
Input AC rated voltage	Nominal: 1/2 phases, 200...500Vac (range 187...550Vac)		
Frequency	47...63Hz		
Input DC rated voltage	250...725Vdc		
Input AC rated current			
V _{in} = 200Vac		1.4A	
V _{in} = 500Vac		0.7A	
Input DC rated current			
V _{in} = 250Vdc		0.8A	
V _{in} = 725Vdc		0.3A	
Inrush peak current		≤ 40A	
Touch (leakage) current		≤ 1mA	
Internal protection fuse	None, external fuse must be provided		
Recommended external protection	Fuse MCB 6A C or 6A D curve / SPD		
GENERAL DATA			
Efficiency	> 81% ... > 84%	> 88%	> 86%
Dissipated power	< 25W ... < 20W	< 17W	< 19.5W
Operating temperature	- 40°C...+ 70°C (UL certified up to 45°C)		
Derating	No derating up to 60°C, derating - 1.2W/°C over 60°C		
Lifetime expectancy	84'914h (9.6 years) at 25°C ambient full Load		
Overvoltage category	III		
Pollution degree	2 (IEC60664-1)		
Input / output isolation	4.2kVdc		
Input / ground isolation	2.2kVdc		
Output / ground isolation	0.75kVdc		
Standards & Approvals	UL508 (certified), UL60950 (certified for NPSW120-24 model and for reference), CE marking		
EMC Standards	EN61000-6-2, EN61000-6-4		
Protection degree	IP20 (EN60529)		
Connection terminals	2.5mm ² , screw type pluggable (24...12AWG)		
Case material	Aluminum		
Weight	0.5kg		
Size (W x H x D)	40 x 115 x 110mm		

NPSW240 - 240W, 1/2/3 Phases, Wide Input Range, Compact DIN Rail Power Supply

- High efficiency and compact size, only 54mm width
- 1, 2 or 3 phases input AC 187...550Vac
- Wide DC input range 250...725Vdc
- Overload 150%
- Excellent field reliability record
- Usable for broad range of industrial, telecom and renewable energy applications



For reference only



TECHNICAL DATA

	NPSW240-12	NPSW240-24	NPSW240-48P	NPSW240-72P
OUTPUT DATA				
Rated voltage	12...15Vdc	24Vdc	48Vdc	72Vdc
Adj. output voltage range	12...15Vdc	23...28Vdc	45...55Vdc	72...85Vdc
Continuous current	15...12A	10A	5A	3.5A
Overload limit (max. 6s)	20A	15A	7.5A	5A
Load regulation	≤ 1%		≤ 1.5%	
Ripple and noise	≤ 100mVpp			
Hold up time				
Vin = 240Vac	≥ 15ms			
Vin = 500Vac	≥ 100ms			
Protections	<ul style="list-style-type: none"> • Overload/short circuit: hiccup • Thermal protection • Output overvoltage 			
Status signals	<ul style="list-style-type: none"> • DC OK - green LED • OVERLOAD - red LED • DC OK - dry contact (NO, 1A / 24Vdc) 			
Parallel connection	<ul style="list-style-type: none"> • Possible for redundancy (with external ORing module) • P (models) - include internal ORing circuit 			
INPUT DATA				
Input AC rated voltage	Nominal: 1/2/3 phases, 200...500Vac (range 187...550Vac)			
Frequency	47...63Hz			
Input DC rated voltage	250...725Vdc			
Input AC rated current				
Vin = 200Vac 1/2Ph			2.2A	
Vin = 500Vac 1/2Ph			1.1A	
Vin = 200Vac 3Ph			1.5A	
Vin = 500Vac 3Ph			0.8A	
Input DC rated current				
Vin = 250Vdc	0.9A			1.4A
Vin = 725Vdc	0.4A			0.5A
Inrush peak current	≤ 60A			
Touch (leakage) current	≤ 1.3mA			
Internal protection fuse	None, external fuse must be provided			
Recommended external protection	Fuse 6.3AT or MCB 6A C or 4A D curve / SPD			
GENERAL DATA				
Efficiency	> 89%	> 93%	> 91%	> 92%
Dissipated power	< 22.5W	< 18W	< 23.5W	< 22W
Operating temperature	- 40°C...+ 70°C (UL certified up to 50°C)			
Derating	- 4.2W/°C over 50°C			
Lifetime expectancy	81'648h (9.3 years) at 25°C ambient full Load			
Overvoltage category	III			
Pollution degree	2 (IEC60664-1)			
Input / output isolation	4.2kVdc			
Input / ground isolation	2.2kVdc			
Output / ground isolation	0.75kVdc			
Standards & Approvals	UL508 (certified), UL60950 (certified for NPSW120-24 model and for reference), CE marking			
EMC Standards	EN61000-6-2, EN61000-6-4			
Protection degree	IP20 (EN60529)			
Connection terminals	2.5mm ² , screw type pluggable (24...12AWG)			
Case material	Aluminum			
Weight	0.65kg			
Size (W x H x D)	54 x 115 x 110mm			

NPSW480 - 480W, 1/2/3 Phases, Wide Input Range, Compact DIN Rail Power Supply

- High efficiency and compact size, only 73mm width
- 1, 2 or 3 phases input AC 187...550Vac
- Wide DC input range 250...725Vdc
- Active PFC
- Excellent field reliability record
- Usable for broad range of industrial, telecom and renewable energy applications

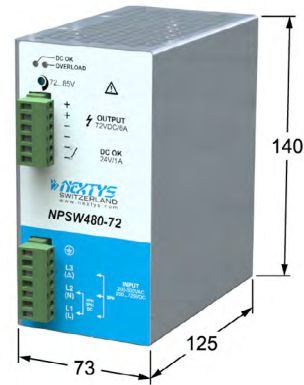

For reference only



TECHNICAL DATA

	NPSW480-24	NPSW480-48	NPSW480-72
OUTPUT DATA			
Rated voltage	24Vdc	48Vdc	72Vdc
Adj. output voltage range	23...28Vdc	45...55Vdc	72...85Vdc
Continuous current	20A	10A	6A
Overload limit	28A	14A	9A
Load regulation	≤ 1 %		
Ripple and noise	≤ 50mVpp		≤ 100mVpp
Hold up time	≥ 50ms		
Protections	<ul style="list-style-type: none"> • Overload/short circuit: hiccup mode • Thermal protection • Output overvoltage 		
Status signals	<ul style="list-style-type: none"> • DC OK - green LED • OVERLOAD - red LED • DC OK - dry contact (NO, 1A / 24Vdc) 		
Parallel connection	Possible for redundancy (with external ORing module)		
INPUT DATA			
Input AC rated voltage	Nominal: 1/2/3 phases, 200...500Vac (range 187...550Vac)		
Frequency	47...63Hz		
Input DC rated voltage	250...725Vdc		
Input AC rated current			
Vin = 200Vac 1/2Ph	2.9A		
Vin = 500Vac 1/2Ph	1.3A		
Vin = 200Vac 3Ph	1.8A		
Vin = 500Vac 3Ph	0.8A		
Input DC rated current			
Vin = 250Vdc	2.1A		
Vin = 725Vdc	0.8A		
Power factor correction	Active / > 0.9		
Inrush peak current	≤ 60A		
Touch (leakage) current	≤ 0.6mA		
Internal protection fuse	None, external fuse must be provided		
Recommended external protection	Fuse 6.3AT or MCB 6A C or 4A D curve / SPD		
GENERAL DATA			
Efficiency	> 92%		> 91%
Dissipated power	< 42W		< 42.5W
Operating temperature	- 40°C...+ 70°C (UL certified up to 45°C)		
Derating	- 10W/°C over 45°C		
Lifetime expectancy	65'496h (7.4 years) at 25°C ambient full load		
Overvoltage category	III		
Pollution degree	2 (IEC60664-1)		
Input / output isolation	4.2kVdc		
Input / ground isolation	2.2kVdc		
Output / ground isolation	0.75kVdc		
Standards & Approvals	UL508 (certified), EN60950 (reference), CE marking		
EMC Standards	EN61000-3-2, EN61000-6-2, EN61000-6-4		
Protection degree	IP20 (EN60529)		
Connection terminals	2.5mm ² , screw type pluggable (24...12AWG)		
Case material	Aluminum		
Weight	1kg		
Size (W x H x D)	73 x 140 x 125mm		

- High efficiency
- 1 or 2 phases input AC 187...528Vac
- Latched overload and short-circuit protection
- Excellent field reliability record
- Designed in according to EN12015, EN12016 for elevators use



For reference only

TECHNICAL DATA

WEPS160-26	
OUTPUT DATA	
Output voltage	26Vdc
Adj. output voltage range	26Vdc Fixed
Continuous current	6A
Overload limit	Up to 10A for 5s, latched protection
Load regulation	≤ 1%
Ripple and noise	≤ 150mVpp
Hold up time	
Vin = 240Vac	≥ 20ms
Vin = 480Vac	≥ 110ms
Protections	<ul style="list-style-type: none"> • Overload and overvoltage latched off • Thermal protection • Output overvoltage
Status signals	<ul style="list-style-type: none"> • DC OK - green LED • ALARM - red LED
Parallel connection	Possible for redundancy (with external ORing module)
INPUT DATA	
Input AC rated voltage	Nominal: 1/2 phases, 380Vac (range 187...528Vac)
Frequency	47...63Hz
Input AC rated current	
Vin = 187Vac	1.8A
Vin = 380Vac	1A
Vin = 528Vac	0.8A
Inrush peak current	≤ 30A
Touch (leakage) current	≤ 0.8mA
Internal protection fuse	None, external fuse must be provided
Recommended external protection	Fuse 4AT or MCB 6A C curve / SPD
GENERAL DATA	
Efficiency	> 88%
Dissipated power	< 25W
Operating temperature	- 40°C...+ 50°C
Derating	- 15W/°C over 45°C
Lifetime expectancy	77'726h (8.8 years) at 25°C ambient full load
Overvoltage category	III
Pollution degree	2 (IEC60664-1)
Input / output isolation	4.2kVdc
Input / ground isolation	2.2kVdc
Output / ground isolation	0.75kVdc
Standards & Approvals	UL508 (reference), EN60950 (reference), CE marking
EMC Standards	EN12015, EN12016, EN61000-6-2, EN61000-6-4
Protection degree	IP20 (EN60529)
Connection terminals	2.5mm ² , screw type header (24...12AWG)
Case material	Aluminum
Weight	0.5kg
Size (W x H x D)	108.5 x 110 x 74.5mm



- High efficiency and compact size
- Active PFC
- Digital Power regulation
- Wide input voltage range 170...550Vac
- Wide output voltage range 36...205Vdc
- 2 user programmable voltage steps with settable duration
- Remote ON/OFF input
- Multiple protections
- Ideal for elevator applications
- Excellent versatility, allowing parts stock savings



For reference only



TECHNICAL DATA

SBP200

OUTPUT DATA

Rated voltage	36...205Vdc (1V resolution programmable)
Continuous current	2.3A or $V_{out} \times I_{out} = 187W$ max. for $V_{out} > 80V$
Overload limit	2.4A
Load regulation	≤ 1%
Ripple and noise	≤ 600mVpp
Hold up time $V_{in} = 240Vac$	≥ 30ms

Protections	<ul style="list-style-type: none"> • Overload and short circuit with constant current (3s) and one shot (no auto recovery) • Thermal protection • Input undervoltage lockout (UVLO) • Input overvoltage protection (VDR)
-------------	--

User interface	<ul style="list-style-type: none"> • 7 segment, 3 digits display • 3 programming keys • ENABLE - isolated remote ON/OFF input, active for 12...230Vac/dc
----------------	--

Parallel connection Possible for power or redundancy (with external ORing module)

INPUT DATA

Input AC rated voltage	Nominal: 1/2 phases, 200...500Vac (range 170...550Vac)
Frequency	47...63Hz
Input DC rated voltage	250...725Vdc
Input AC rated current	
$V_{in} = 200Vac$	1.4A
$V_{in} = 500Vac$	0.5A
Input DC rated current	
$V_{in} = 250Vdc$	1.4A
$V_{in} = 725Vdc$	0.7A
Power factor correction	Active / > 0.9
Inrush peak current	≤ 50A
Touch (leakage) current	≤ 0.3mA
Internal protection fuse	None, external fuse must be provided
Recommended external protection	MCB 6A C or 4A D curve / SPD

GENERAL DATA

Efficiency	> 87%
Dissipated power	< 28W
Operating temperature	- 40°C...+ 70°C
Derating	- 4.2W/°C over 50°C (do not exceed $V_{out} \times I_{out} = 100W$ max. at 70°C)
Lifetime expectancy	71'686h (8.1 years) at 25°C ambient full load
Overvoltage category	III
Pollution degree	2 (IEC60664-1)
Input / output isolation	4.2kVdc
Input / ground isolation	3.4kVdc
Input / enable isolation	4.2kVdc
Output / ground isolation	1.65kVdc
Output / enable isolation	4.2kVdc
Enable / ground isolation	4.2kVdc
Standards & Approvals	UL508 (reference), EN50178 (reference), EN60950 (certified), CE marking
EMC Standards	EN12015, EN12016, EN61000-3-2, EN61000-6-2, EN61000-6-4
Protection degree	IP20 (EN60529)
Connection terminals	2.5mm ² , screw type pluggable (24...12AWG)
Case material	Aluminum
Weight	0.75kg
Size (W x H x D)	80 x 120 x 100mm

SBP200L - 200W, 24...120Vdc DIN Rail Programmable Output Voltage Power Supply

- High efficiency and compact size
- Active PFC
- Digital Power regulation
- Wide input voltage range 170...550Vac
- Wide output voltage range 24...120Vdc, user settable
- User settable current limitation threshold
- Remote ON/OFF or other remote control functions
- Modbus over RS-485 interface for control and monitoring
- Can be used as battery charger and for LED lighting
- 2 user programmable voltage steps with settable duration
- High operating temperature with no derating
- Suitable for **POWERMASTER** software
- Excellent versatility, allowing parts stock savings



For reference only

NEW



TECHNICAL DATA

SBP200L

OUTPUT DATA

Rated voltage	24...120Vdc (1V resolution programmable)
Continuous current	4.0A@24Vdc, 3.0A@48Vdc or $V_{out} \times I_{out} = 200W$ max. for $V_{out} > 48Vdc$
Overload limit	4.4A to 1.9A (depending on V_{out})
Load regulation	$\leq 1\%$
Ripple and noise	$\leq 200mVpp$
Hold up time	
$V_{in} = 400Vac$	$\geq 25ms$
Battery charger function	C.C./C.V. (setup via front panel or POWERMASTER application)

Protections

- Overload and short circuit protections
- Thermal protection
- Input undervoltage lockout (UVLO)
- Input overvoltage protection (VDR)

User interface

- 7 segment, 3 digits display
- 3 programming keys
- **ENABLE** - isolated remote ON/OFF input, active for 5...30Vdc
- **DC OK** - dry contact (NO, 1A / 24Vdc)
- **Modbus over RS-485** interface - possible by **USB** to **RS-485** converter (P/N: **MODUS**)

Parallel connection

Possible for power or redundancy (with external ORing module)

INPUT DATA

Input AC rated voltage	Nominal: 1/2 phases, 200...500Vac (range 170...550Vac)
Frequency	47...63Hz
Input DC rated voltage	250...725Vdc
Input AC rated current	
$V_{in} = 200Vac$	1.4A
$V_{in} = 500Vac$	0.5A
Input DC rated current	
$V_{in} = 250Vdc$	1A
$V_{in} = 725Vdc$	0.4A
Power factor correction	Active / > 0.9
Inrush peak current	$\leq 50A$
Touch (leakage) current	$\leq 0.4mA$
Internal protection fuse	None, external fuse must be provided
Recommended external protection	MCB 10A C curve / SPD

GENERAL DATA

Efficiency	$> 82\% \dots > 90\%$ (depending on V_{out})
Dissipated power	$< 21W$
Operating temperature	$-40^{\circ}C \dots +70^{\circ}C$
Derating	Over 60Vdc 1.5W/ $^{\circ}C$ over 50 $^{\circ}C$ Under 60Vdc 3.0W/ $^{\circ}C$ over 50 $^{\circ}C$
Lifetime expectancy	71'686h (8.1 years) at 25 $^{\circ}C$ ambient full load
Overvoltage category	III
Pollution degree	2 (IEC60664-1)
Input / output isolation	4.2kVdc
Input / ground isolation	2.2kVdc
Output / ground isolation	0.75kVdc
Standards & Approvals	UL508 (reference), EN50178 (reference), EN60950 (reference), CE marking
EMC Standards	EN61000-3-2, EN61000-6-2, EN61000-6-4
Protection degree	IP20 (EN60529)
Connection terminals IN/OUT	2.5mm ² , screw type pluggable (24...12AWG)
Auxiliary contacts connectors	Up to 0.5mm ² , Fast Pluggable type (20AWG) 4pins, 2.5mm pitch
Communication interface connector	RS-485 through RJ45 Female
Case material	Aluminum
Weight	0.75kg
Size (W x H x D)	80 x 120 x 100mm



WIDE CHOICE FOR VOLTAGE ADAPTING

- ✓ Compact design
- ✓ Wide input voltage range
- ✓ 2.2kV isolated I/O suitable for industrial automation
- ✓ High reliability
- ✓ High overload capacity
- ✓ LED and dry contact signalling
- ✓ Pluggable terminals
- ✓ Short circuit, overload, over temperature protection
- ✓ Unique universal programmable IN/OUT model (NDW240)

Applications:

- ✓ Industrial machine control
- ✓ Process control
- ✓ Energy management
- ✓ Remote control systems
- ✓ Railway



Power	Model	Vdc IN	Vdc OUT	A
3W	NDD3-1205	9...18	5	0.6
120W	NDD120-1212	10.5...18	12...15	7
	NDD120-1224	10.5...18	24	5
	NDD120-2412	18...36	12...15	7
	NDD120-2424	18...36	24	5
	NDD120-4812	36...72	12...18	8
	NDD120-4824	36...72	24	5
240W	NDW240	11...55	5...55	10
	NDD240-11024	90...148	24	10

- High efficiency and compact size
- Plastic enclosure, circuit breaker shape
- Overload 140%
- Up to 70°C operating temperature

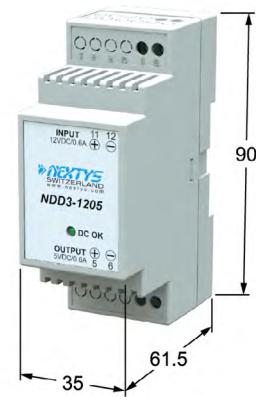

For reference only

TECHNICAL DATA

NDD3-1205	
OUTPUT DATA	
Rated voltage	5Vdc ± 3% max.
Continuous current	0.6A
Overload limit	0.85A
Load regulation	≤ 1%
Ripple and noise	≤ 30mVpp
Hold up time	≥ 10ms
Protections	Overload/short circuit: hiccup mode
Status signals	DC OK - green LED
Parallel connection	Possible for redundancy (with external ORing module)
INPUT DATA	
Input DC rated voltage	Nominal: 12Vdc (range 9...18Vdc)
Input DC current	0.6A
Internal protection fuse	Fuse 1.25AT (not user replaceable)
GENERAL DATA	
Efficiency	> 68%
Dissipated power	< 1.4W
Operating temperature	- 40°C...+ 70°C
Derating	0.08W/°C over 60°C
Lifetime expectancy	211'118h (24.1 years) at 25°C ambient full load
Overvoltage category	I
Pollution degree	2 (IEC60664-1)
Input / output isolation	1.5kVdc
Standards & Approvals	UL508 (reference), EN60950 (reference), CE marking
EMC Standards	EN61000-6-2, EN61000-6-3
Protection degree	IP20 (EN60529)
Connection terminals	2.5mm ² , screw type header (24...12AWG)
Case material	ABS, Flame retardant UL94 V-0
Weight	0.1kg
Size (W x H x D)	35 x 90 x 61.5mm

- High efficiency and compact size
- Isolated topology
- Wide input voltage range
- Overload 125%
- Excellent field reliability record



For reference only

TECHNICAL DATA

	NDD120-1212	NDD120-1224	NDD120-1248	NDD120-2412	NDD120-2424	NDD120-4812	NDD120-4824	
OUTPUT DATA								
Rated voltage	12Vdc	24Vdc	48Vdc	12Vdc	24Vdc	12Vdc	24Vdc	
Adj. output voltage range	12...15Vdc	23...27.5Vdc	45...55Vdc	12...15Vdc	23...27.5Vdc	12...15Vdc	23...27.5Vdc	
Continuous current	7A	5A	2.5A	7A	5A	8A	5A	
Overload limit	9A	7A	3.3A	9A	6.5A	12A	6.5A	
Load regulation							≤ 0.5%	≤ 1.5%
Ripple and noise	≤ 20mVpp			≤ 50mVpp	≤ 20mVpp		≤ 30mVpp	
Hold up time	≥ 4ms		≥ 3ms			≥ 5ms	≥ 6ms	
Protections	<ul style="list-style-type: none"> • Overload/short circuit: hiccup mode • Thermal protection • Active output overvoltage 							
Status signals	DC OK - green LED					ALARM - red LED	DC OK - Dry contact (NO, 1A / 24Vdc)	
Parallel connection	Possible for redundancy (with external ORing module)							
INPUT DATA								
Input DC rated voltage	Nominal: 12Vdc (range 10.5...18Vdc)		Nominal: 24Vdc (range 18...36Vdc)		Nominal: 48Vdc (range 36...72Vdc)			
Input DC rated current								
Vin min.	14A	15.5A	7.5A	8.5A	4.5A	4.3A		
Vin max.	8A	9A	3.8A	4.3A	2.5A	2.2A		
Input overvoltage protection	19Vdc active shutdown		38Vdc active shutdown		76Vdc active shutdown			
Internal protection fuse (not user replaceable)	Fuse 20AT		Fuse 10AT		Fuse 8AT	Fuse 5AT		
External protection on DC line (use DC rated devices)	MCB 25A C curve		MCB 13A C curve		MCB 6A C curve			
GENERAL DATA								
Efficiency	> 81%	> 82%	> 83%	> 86%		> 89%		
Dissipated power	< 20W	< 25W	< 24W	< 14W	< 20W	< 15W	< 16W	
Operating temperature	- 40°C...+ 70°C							
Derating	- 3W/°C over +50°C							
Lifetime expectancy	64'000h (7.3 years) at 25°C ambient full load							
Overvoltage category	I							
Pollution degree	2 (IEC60664-1)							
Input / output isolation	2.1kVdc							
Input / ground isolation	1.41kVdc							
Output / ground isolation	0.75kVdc							
Standards & Approvals	UL508 (reference), EN60950 (reference), CE marking							
EMC Standards	EN61000-6-2, EN61000-6-4							
Protection degree	IP20 (EN60529)							
Connection terminals	2.5mm ² , screw type pluggable (24...12AWG)							
Case material	Aluminum							
Weight	0.5kg							
Size (W x H x D)	54 x 115 x 110mm							

- High efficiency and compact size
- Isolated topology
- Wide input voltage range
- Overload 150%
- Excellent field reliability record



For reference only

TECHNICAL DATA

NDD240-11024

OUTPUT DATA

Rated voltage	24Vdc
Adj. output voltage range	23...27.5Vdc
Continuous current	10A
Overload limit	15A
Load regulation	≤ 1.5%
Ripple and noise	≤ 50mVpp
Hold up time	≥ 10ms

Protections	<ul style="list-style-type: none"> • Overload/short circuit: hiccup mode • Thermal protection • Output overvoltage
-------------	---

Status signals	<ul style="list-style-type: none"> • DC OK - green LED • OVERLOAD - red LED • DC OK - dry contact (NO, 1A / 24Vdc)
----------------	--

Parallel connection Includes internal ORing circuit

INPUT DATA

Input DC rated voltage	110Vdc (range 90...148Vdc)
Input DC rated current	
Vin min.	3.6A
Vin max.	2.6A
Input overvoltage protection	Active shutdown / > 150Vdc
Internal protection fuse	Fuse 5AT (not user replaceable)
Recommended external protection (use DC rated devices)	MCB 6A C curve

GENERAL DATA

Efficiency	> 88.5%
Dissipated power	< 31W
Operating temperature	- 40°C...+ 70°C
Derating	- 4W/°C over 45°C
Lifetime expectancy	64'000h (7.3 years) at 25°C ambient full load
Overvoltage category	I
Pollution degree	2 (IEC60664-1)
Input / output isolation	2.1kVdc
Input / ground isolation	1.41kVdc
Output / ground isolation	0.75kVdc
Standards & Approvals	UL508 (reference), EN60950 (reference), CE marking
EMC Standards	EN61000-6-2, EN61000-6-4
Protection degree	IP20 (EN60529)
Connection terminals	2.5mm ² , screw type pluggable (24...12AWG)
Case material	Aluminum
Weight	0.8kg
Size (W x H x D)	69 x 115 x 110mm

NDW240 - 240W DIN Rail Programmable Output DC/DC Converter

- Up to 240W output power (voltage dependent)
- Converts any voltage between 11V and 55V to any voltage between 5V and 55V
- High efficiency and compact size
- Constant current or hiccup mode limitation, user settable
- Digital Power regulation
- Isolated topology (4.2kVdc)
- Modbus over USB interface for control and monitoring
- Multiple protections integrated
- Parallelable for power or redundancy (integrated ORing circuitry)
- Suitable for **POWERMASTER** software



For reference only



TECHNICAL DATA

OUTPUT DATA		NDW240
Rated voltage		5...55Vdc
Adj. output voltage range		5...55Vdc
Continuous current / power		10A / 240W
Overload limit in constant current		11A / 264W
Overload limit in hiccup (max. 5s)		15A / 360W
Short circuit peak current		18A
Load regulation		≤ 4% @ 5Vdc, ≤ 2% @ 12Vdc, ≤ 1.5% @ ≥ 24Vdc
Ripple and noise		≤ 200mVpp
Hold up time		≥ 5ms
Protections	<ul style="list-style-type: none"> • Overload/short circuit: with constant current or hiccup mode (user settable) • Thermal protection • Output overvoltage 	
Output overvoltage protection		120% of Vout active self tracking
User interface	<ul style="list-style-type: none"> • 7 segment, 2 digits display • 3 programming keys • DC OK - dry contact (NO, 1A / 24Vdc) • Modbus over USB interface 	
Parallel connection		Possible for power or redundancy (with integrated ORing circuitry)
INPUT DATA		
Input DC rated voltage		Nominal: 12...48Vdc (range 11...55Vdc)
Input DC rated current		12A
Protections	<ul style="list-style-type: none"> • Input Overvoltage > 60V active shutdown • Reverse polarity • Fuse 20A mini ATO blade (not user replaceable) 	
External protection on DC line (use DC rated devices)		20A Fuse or MCB 20A C curve
GENERAL DATA		
Efficiency		77% ... 92% (depending on Vin/Vout)
Dissipated power		< 28W (depending on Vin/Vout)
Operating temperature		- 40°C...+ 70°C
Derating		Depending on Vin and Vout over 60°C (see the online datasheet)
Lifetime expectancy		180'542h (20.61 years) at 25°C ambient full load
Overvoltage category		I
Pollution degree		2 (IEC60664-1)
Input / output isolation		4.2kVdc
Input / ground isolation		2.2kVdc
Output / ground isolation		0.75kVdc
Standards & Approvals		UL508 (reference), EN60950 (reference), CE marking
EMC Standards		EN61000-6-2, EN61000-6-3
Protection degree		IP20 (EN60529)
Connection terminals		2.5mm ² , screw type pluggable (24...12AWG)
Case material		Aluminum
Weight		0.4kg
Size (W x H x D)		40 x 115 x 110mm



SMART SOLUTIONS FOR MAXIMUM SYSTEM AVAILABILITY

Suitable for:

- ✓ Generator sets, engine starting
- ✓ Industrial, water pumping, fire protection systems
- ✓ Portable equipment, automatic doors, access control, CCTV, alarms
- ✓ Emergency backup
- ✓ Telecom systems, base transceiver stations
- ✓ Power supply continuity
- ✓ Energy plants and distribution systems user
- ✓ Load selectivity

**High performance
Battery Charger/DC-UPS**



**Integrated SMPS
Battery Charger/DC-UPS**



**Buffer
Module**

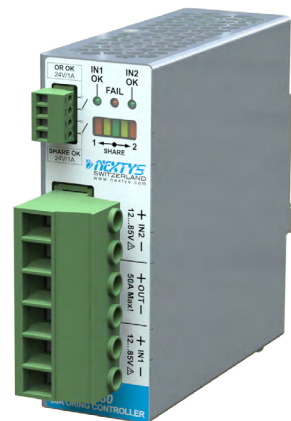

**Redundancy
Module**

- Ultra-compact DC Overcurrent Protector with 2 independent channels
- Classic circuit breaker shape
- Input: 10...31Vdc / 20A max.
- Output: 10A max. / channel (user settable, independently)
- Digital Power regulation
- Programmable Static Switch function
- Advanced CPU control - allows set-up of various tripping curves
- Modbus over USB interface for control and monitoring
- Suitable for **POWERMASTER** software

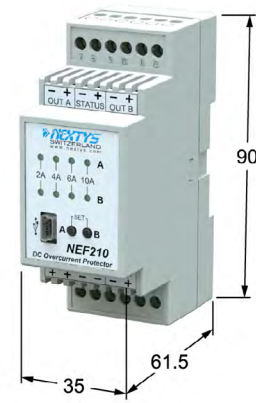

For reference only



TECHNICAL DATA

NEF210

GENERAL DATA

Rated surge voltage	0.5kVdc
Rated DC input voltage	10...31Vdc
Maximum input current	20A
Maximum capacitive load circuit	> 50000µF (per channel at 24Vdc)
Active current limitation	1.5 x I _n (2A / 4A / 6A), 1.2 x I _n (10A)
Tripping thresholds	2A / 4A / 6A / 10A per channel, user settable via key or USB
Time - current characteristic	Very Quick Acting / Fast Acting / Medium Acting / Time Lag - user settable via USB
Waiting time after switch off of a channel	15s (overload / short circuit)
Conduction resistance	< 25mΩ
Efficiency	> 98.5%
Dissipated power	< 5.5W
Standby power	< 1W
Required backup fuse	Not required, integrated failsafe element
Internal output fuse	15A _{dc} (per output channel)
Protections	<ul style="list-style-type: none"> • Overvoltage > 33V
Status signals & user interface	<ul style="list-style-type: none"> • OUT A/B OK: one LED of the channel is ON • OUT A/B TRIPPED: all the LEDs of the channel are blinking • Remote fault indicator (at least 1 channel tripped) by optoisolator (30Vdc / 50mA / open collector) • Remote reset INPUT by optoisolator (5...30Vdc / 20mA) • 1 key / channel for arming / rearming • Modbus over USB interface
Operating temperature	- 40°C...+ 70°C (no derating)
Overvoltage category	I
Pollution degree	2 (IEC60664-1)
Standards & Approvals	EN60950 (reference), CE marking
EMC Standards	EN61000-6-2, EN61000-6-3
Protection degree	IP20 (EN60529)
Connection terminals	2.5mm ² , screw type header (24...12AWG)
Contact type	Without electrical isolation
USB Connector	Mini USB connector
Case material	ABS, Flame retardant UL94 V-0
Weight	0.1kg
Size (W x H x D)	35 x 90 x 61.5mm

L

- High efficiency and compact size
- Provides 3kVAC isolation for DC/DC applications
- Provides more than 800W output power
- Wide voltage range 10...55Vdc
- Output tracks the input voltage as in a standard AC transformer
- Easy parallellable for power increase with natural current sharing (external ORing module needed)
- Hiccup mode current limitation with auto restart
- Up to 70°C operating temperature (with power derating)



For reference only

TECHNICAL DATA

NISO-20

OUTPUT DATA

Rated voltage	10...55Vdc
Continuous current	20A @ 12...24Vdc 17A @ 48Vdc
Overload limit	21A
Load regulation	Not regulated (see the online datasheet)
Output equivalent resistance	110mΩ
Ripple and noise	≤ 80mVpp

Protections	<ul style="list-style-type: none"> • Overload and short circuit protections • Thermal protection • Input undervoltage lockout (UVLO) • Input overvoltage protection (OVLO) • Input transient overvoltage protection (VDR)
-------------	--

User interface	<ul style="list-style-type: none"> • INPUT OK - green LED • OUTPUT OK - green LED • OVERLOAD - red LED • LOAD - bargraph indicating the load current by 4 amber LEDs • DC OK - dry contact (NO, 1A / 24Vdc)
----------------	---

Output overvoltage protection	> 62Vdc
Parallel connection	Possible for power or redundancy (with external ORing module)

INPUT DATA

Input DC rated voltage	Nominal: 12...48Vdc (range 10...55Vdc)
Input DC rated current	20A
Standby power	< 6W
Internal protection fuse	30A ATO blade (not user replaceable)
Recommended external protection (use DC rated devices)	30A Fuse or MCB 25A C curve

GENERAL DATA

Efficiency	> 85% ... > 96% (depending on Vout and Vin)
Dissipated power	< 35W
Operating temperature	- 40°C...+ 70°C
Derating	(see the online datasheet)
Lifetime expectancy	123'361h (14.1 years) at 25°C ambient full load
Overvoltage category	I
Pollution degree	2 (IEC60664-1)
Input / output isolation	4.2kVdc
Input / ground isolation	2.2kVdc
Output / ground isolation	0.75kVdc
Standards & Approvals	UL508 (reference), EN60950 (reference), CE marking
EMC Standards	EN61000-6-2, EN61000-6-4
Protection degree	IP20 (EN60529)
Connection terminals	2.5mm ² , screw type pluggable (24...12AWG)
Case material	Aluminum
Weight	0.5kg
Size (W x H x D)	54 x 115 x 110mm

DCU20 - 20A DIN Rail High Performance DC-UPS

- Digital Power regulation, LCD interface
- Multiple user settable parameters
- BI VOLTAGE: 12 or 24Vdc (intermediate voltages possible)
- Battery chemistry: lead acid, nickel and lithium
- Maximum battery capacity 150Ah
- Load current: 20A max.
- Multiple protections, battery health monitoring
- Remote shut down by signal or PC
- Cold start
- Suitable for **POWERMASTER** software



For reference only



TECHNICAL DATA

DCU20

INPUT DATA

Input DC rated voltage	Nominal: 11...28Vdc (range 10...29Vdc)
Input DC rated current	20A
Standby power	< 3W

BATTERY SECTION

Rated battery voltage	<ul style="list-style-type: none"> • 12 or 24Vdc • Other voltages possible by request
Battery chemistries	<ul style="list-style-type: none"> • Lead acid • Nickel • Lithium
Maximum battery charge current	5A
Allowed battery capacity	up to 150Ah
Maximum battery current	20A (up to 35A for 5s)
"Load to Battery" switch time	< 5μs
Battery protections	<ul style="list-style-type: none"> • Overcurrent • Deep discharge • Reverse polarity

BATTERY HEALTH MONITOR

Battery internal resistance range	1mΩ...300mΩ (using Kelvin connection)
Additional monitoring functions	<ul style="list-style-type: none"> • Coulomb counter • Battery temperature through optional sensor WNTC-2MT • Battery operating time since installation • Number of cycles

USER INTERFACE

1.5 inch color graphic LCD	Used to display the unit's status and to access the configuration menus
4 keys	Used to program the unit and to access various menus
Red LED	<ul style="list-style-type: none"> • Constantly ON: generic failure on the system, details on the LCD • Blinking: battery backup function active
2 dry contacts (relays) rated 1A / 30V	<ul style="list-style-type: none"> • May indicate unit status (READY or on BACKUP mode), battery failure (by toggling at 1Hz) • Configurable for remote PC shutdown
Other interfaces	<ul style="list-style-type: none"> • INHIBIT - remote ON/OFF input • Mini USB connector • T SENSE - optional, remote temperature sensor for battery charging (WNTC-2MT)

GENERAL DATA

Efficiency / Power loss at full load (on power supply)	> 97.5% / < 13W
Efficiency / Power loss at full load (on battery)	> 96.5% / < 18W
Battery charger efficiency / power loss	> 90% / < 16W
Maximum backup time	User programmable, up to battery deep discharge threshold
Operating temperature	- 40°C...+ 60°C (for T < - 20°C the LCD is not operating, but the unit will operate correctly)
Lifetime expectancy	253'142h (28.9 years) at 25°C ambient full load
Isolation against enclosure	0.75kVdc
Standards & Approvals	UL508 (certified), EN60950 (reference), CE marking
EMC Standards	EN61000-6-2, EN61000-6-4
Protection degree	IP20 (EN60529)
IN / Battery / OUT Connectors	2.5mm ² , screw type pluggable (24...12AWG)
Auxiliary contacts connectors	Up to 0.5mm ² , fast pluggable type (20AWG)
Temperature sensor connectors	Friction lock connector
USB Connector	Mini USB connector
Case material	Aluminum
Weight	0.5kg
Size (W x H x D)	54 x 115 x 110mm

DCW20 - 960W DIN Rail Combo DC-UPS / DC-DC Converter

- Integrated battery charger and battery health monitoring for 12...48V multi-chemistries batteries (up to 400Ah)
- Can operate on super capacitors modules
- Battery voltage independent of input and output voltage
- 20A or 960W rated load
- Remote input with programmable functions
- Modbus over USB and RS-485 interfaces for control and monitoring
- 4 keys and 1 color graphic LCD display for status and alarms
- 2 dry contacts for programmable status signals
- Auxiliary output with same voltage as battery voltage (5A max.), protected against overcurrent/shortcircuit
- Suitable for **POWERMASTER** software

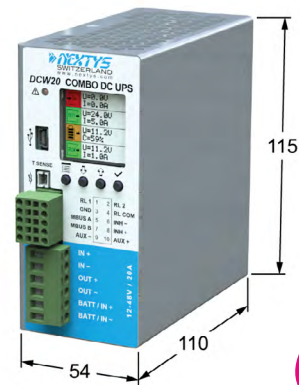

For reference only



TECHNICAL DATA

DCW20

INPUT DATA

Input DC rated voltage	Nominal: 12...48Vdc (range 10...60Vdc)
Input DC rated current	20A
Standby power	< 4W

MAIN OUTPUT SECTION

Voltage	Nominal: 12...48Vdc (= Vin for use as UPS; according to set-up for use as DC/DC converter)
Current / Power	20A / 960W
Load regulation	± 1%

AUXILIARY OUTPUT SECTION

Voltage	Nominal: 12...48Vdc (= U battery - non regulated)
Continuous current	5A
Overload limit	6A

BATTERY SECTION

Battery rated voltage (or to be used as input for DC/DC conversion)	Nominal: 12...48Vdc (range 10...60Vdc)
Battery chemistries	Lead acid / Nickel / Lithium / Supercap capacitors
Maximum battery charge current	20A
Maximum battery discharge current	20A
Allowed battery capacity	up to 400Ah
Battery protection	Overcurrent / Deep discharge / Reverse polarity

BATTERY HEALTH MONITOR

Battery internal resistance range	1mΩ...300mΩ (using Kelvin connection)
Additional monitoring functions	<ul style="list-style-type: none"> • Coulomb counter • Battery operating time since installation • Battery temperature through optional sensor (WNTC-2MT) • Number of discharge cycles

USER INTERFACE

1.5 inch color graphic LCD	Used to display the unit's status and to access the configuration menus
4 keys	Used to program the unit and to access various menus
Red LED	<ul style="list-style-type: none"> • Constantly ON: generic failure on the system, details on the LCD • Blinking: battery backup function active
Other interfaces	<ul style="list-style-type: none"> • Modbus over USB and RS-485 interfaces • 2 dry contacts (relays) 1A / 30V, user settable for various functions (see user's manual) • INH (INHIBIT) - Remote ON/OFF input • T SENSE - optional, remote temperature sensor for battery charging (WNTC-2MT)

GENERAL DATA

Efficiency at full load	> 97%
Power loss (in UPS mode)	< 15W
Efficiency at full load	> 97%
Power loss (DC-DC mode)	< 15W
Battery charger efficiency	> 96%
Power loss	< 20W
Maximum backup time	User programmable, up to battery deep discharge threshold
Operating temperature	- 40°C...+ 80°C (see the online datasheet)
Lifetime expectancy	281'904h (32.2 years) at 25°C ambient full load
Isolation against enclosure	0.75kVdc
Standards & Approvals	UL508 (reference), EN60950 (reference), CE marking
EMC Standards	EN61000-6-2, EN61000-6-3
Protection degree	IP20 (EN60529)
IN / Battery / OUT Connectors	2.5mm ² , screw type pluggable (24...12AWG)
Auxiliary contacts connectors	Up to 0.75mm ² , fast pluggable type (18AWG)
Temperature sensor connector	Friction lock connector
Communication interface connectors	<ul style="list-style-type: none"> • Mini USB-B Type (virtual Com Port) • RS-485 through auxiliary connector
Case material	Aluminum
Weight	0.5kg
Size (W x H x D)	54 x 115 x 110mm

- Low cost DC-UPS with charging function of a 12 or 24Vdc battery
- Suitable for power supplies with adjustable output
- Allows to feed the load and to charge the battery simultaneously
- Built-in battery overcurrent protection fuse
- Battery deep discharge protection
- To be used with lead acid and lithium batteries (compatible with lead acid batteries)
- Instantaneous LOAD switch to BACKUP mode

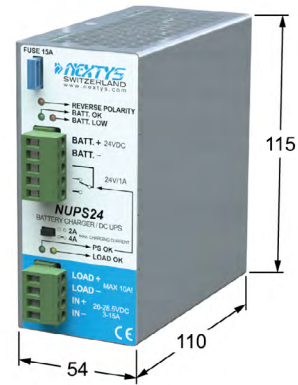

For reference only



TECHNICAL DATA

	NUPS12	NUPS24
OUTPUT DATA		
Load nominal voltage	10...15Vdc	20...28Vdc
Charging current Limit (Settable)	2A or 4A	
Load maximal current	10A	
Battery fuse	15A / 32V - Mini blade type, user replaceable	
Battery float voltage	[Vin - 0.4V], 11Vdc min.	[Vin - 0.4V], 26Vdc min.
Deep discharge cut-off voltage	9.2Vdc ± 0.5V	18Vdc ± 0.5V
Chargeable capacity of the battery vs power supply voltage	75% @ 13Vdc	75% @ 26Vdc
	85% @ 13.5Vdc	85% @ 27Vdc
	100% @ 14Vdc	100% @ 28Vdc
"Batt. OK" LED	ON for U Batt. > 11.6Vdc ± 0.2V	ON for U Batt. > 23.5Vdc ± 0.2V
"Batt. LOW" LED	ON for U Batt. < 11.6Vdc ± 0.2V	ON for U Batt. < 23.5Vdc ± 0.2V
Protections	<ul style="list-style-type: none"> • Battery reverse connection • Battery short-circuit/overload • Battery deep discharge 	
Status signals	<ul style="list-style-type: none"> • PS OK - green LED • LOAD OK - yellow LED • BATT. OK - green LED • BATT. LOW - red LED • REVERSE POLARITY - red LED • Dry contact 1A / 24Vdc 	
INPUT DATA		
Input DC rated voltage from Power Supply	13...15.5Vdc	26...28.5Vdc
Input DC rated current	3...15A	
GENERAL DATA		
Operating temperature	- 40°C...+ 50°C	
Derating	No Derating	
Lifetime expectancy	64'000h (7.3 years) at 25°C ambient full load	
Overvoltage category	I	
Pollution degree	2 (IEC60664-1)	
Isolation against enclosure	0.75kVdc	
Standards & Approvals	UL508 (certified), EN60950 (reference), CE marking	
EMC Standards	EN61000-6-2, EN61000-6-3	
Protection degree	IP20 (EN60529)	
Connection terminals	2.5mm ² , screw type pluggable (24...12AWG)	
Case material	Aluminum	
Weight	0.3kg	
Size (W x H x D)	54 x 115 x 110mm	

- “All-in-one” economic solution for general purpose applications
- Input: 120-240Vac
- Output: 12 or 24Vdc - model dependent
- To be used with lead acid and lithium batteries (compatible with lead acid batteries)
- Instantaneous LOAD switch to BACKUP mode

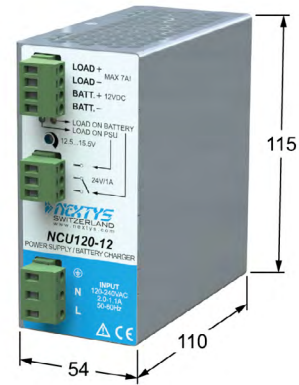

For reference only

TECHNICAL DATA

	NCU120-12	NCU120-24
OUTPUT DATA		
Rated voltage	12Vdc	24Vdc
Adj. output voltage range	12.5...15.5Vdc (to be set at 14Vdc for correct battery charging)	23...27.5Vdc (to be set at 27Vdc for correct battery charging)
Continuous current	7A	5A
Overload limit	11.5A	6.5A
Load regulation	≤ 1%	
Ripple and noise	≤ 100mVpp	
Hold up time		
Vin = 120Vac	≥ 10ms	≥ 10ms
Vin = 240Vac	≥ 80ms	≥ 55ms
Protections	<ul style="list-style-type: none"> • Overload/short circuit: hiccup • Thermal protection • Output overvoltage 	
Battery Protection	<ul style="list-style-type: none"> • Against short-circuit with resettable fuse (9A) • Against reverse polarity connection • Against deep discharge (9V for NCU120-12 and 18V for NCU120-24 model) 	
Status signals	<ul style="list-style-type: none"> • LOAD ON PSU - green LED • LOAD ON BATTERY - amber LED • Dry contact 1A / 24Vdc 	
BATTERY INFO		
Rated voltage	12...14.4Vdc	24...28.8Vdc
Charging current	0.8A max.	
INPUT DATA		
Input AC rated voltage	Nominal: 120...240Vac (range 100...264Vac)	
Frequency	47...63Hz	
Input DC rated voltage	140...345Vdc	
Input AC rated current		
Vin = 120Vac	2A	
Vin = 240Vac	1.1A	
Input DC rated current		
Vin = 140Vdc	1A	
Vin = 345Vdc	0.5A	
Inrush peak current	≤ 40A	
Touch (leakage) current	≤ 0.6mA	
Internal protection fuse	Fuse 3.15AT (not user replaceable)	
Recommended external protection	Fuse 4AT or MCB 4A C curve / SPD	
GENERAL DATA		
Efficiency	> 83.5%	> 86%
Dissipated power	< 21W	< 20W
Operating temperature	- 40°C...+ 70°C	
Derating	- 0.6W/°C over 45°C	- 0.96W/°C over 45°C
Lifetime expectancy	64'000h (7.3 years) at 25°C ambient full load	
Overvoltage category	III	
Pollution degree	2 (IEC60664-1)	
Input / output isolation	4.2kVdc	
Input / ground isolation	2.2kVdc	
Output / ground isolation	0.75kVdc	
Standards & Approvals	UL508 (reference), EN60950 (reference), CE marking	
EMC Standards	EN61000-6-2, EN61000-6-4	
Protection degree	IP20 (EN60529)	
Connection terminals	2.5mm ² , screw type pluggable (24...12AWG)	
Case material	Aluminum	
Weight	0.5kg	
Size (W x H x D)	54 x 115 x 110mm	

BU150U - 500W / 0.3s Universal Input Range, 150J Buffer Module

- Wide voltage range: 12...85Vdc
- Self tracking DC BUS voltage
- > 150 Joules energy storage
- Compact size
- Reliable topology, based on standard electrolytic capacitors
- Dry contacts for status signalling and opto-isolated input for INHIBIT
- Digital Power regulation
- Multiple protections, integrated safety circuit that disconnects the capacitor bank in case of internal failure
- Can boost the peak power of the DC supply
- Parallelable for power and backup time increase

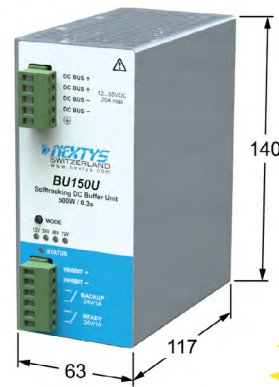

For reference only



TECHNICAL DATA

BU150U

OUTPUT DATA

Unom Voltage Vin - 1V (12/24/48/72Vdc - 1V)

- | | |
|---------------------------|--|
| Continuous output current | <ul style="list-style-type: none"> • 20A @ <48V • 16A @ >48V |
| Backup duration | <ul style="list-style-type: none"> • 600ms / 12V @ 20A • 300ms / 24V @ 20A • 130ms / 48V @ 20A • 140ms / 72V @ 16A |

Ripple and noise @ I max. < 250mVpp / 24Vdc

- | | |
|------------|---|
| Protection | <ul style="list-style-type: none"> • Overload - active • Short circuit - one shot • Overvoltage - active |
|------------|---|

- | | |
|----------------|--|
| Status signals | <ul style="list-style-type: none"> • Voltage level by amber LEDs • STATUS - CHARGING / READY by Bi-color LED • BACKUP - dry contact 1A / 24V • READY - dry contact 1A / 24V • INHIBIT - remote ON/OFF input |
|----------------|--|

INPUT DATA

Input DC rated voltage Nominal: 12/24/48/72Vdc - Auto detection (12...85Vdc)

- | | |
|------------------------|--|
| Input DC rated current | <ul style="list-style-type: none"> • 20A max. @ < 48Vdc • 16A max. @ > 48Vdc |
|------------------------|--|

Charging time < 40s, voltage dependent (see the online datasheet)

GENERAL DATA

- | | |
|-----------------|--|
| Operating modes | <ul style="list-style-type: none"> • AUTO: senses the input voltage and supplies the load when the voltage drops • MANUAL: fixed output voltage (12/24/48/72Vdc), user settable by front key |
|-----------------|--|

Control Digital by CPU

Operating temperature - 40°C...+ 70°C

Storage temperature - 20°C...+ 80°C

Lifetime expectancy 191'936h (21.9 years) at 25°C ambient full load

Cooling Natural convection

DC bus / ground isolation 0.75kVdc

Safety standards UL508 (certified), EN60950 (reference), CE marking

EMC Standards EN61000-6-2, EN61000-6-4

Protection degree IP20 (EN60529)

Connection terminals 2.5mm², screw type pluggable (24...12AWG)

Case material Aluminum

Weight 0.9kg

Size (W x H x D) 63 x 140 x 117mm

- Designed for hosting 2 standard sealed lead acid batteries 12Vdc / 1.2Ah (not provided)
- Settable output voltage: 12-24Vdc / 2.4-1.2Ah
- Integrated self resettable overcurrent protection



For reference only

TECHNICAL DATA

		NBP30
BATTERY PACK INFO		
Voltage / Capacity	2 x lead acid sealed batteries 12Vdc / 1.2Ah	
Battery Size (W x H x D)	48.5 x 54.5 x 97.5mm max.	
Internal protection fuse	15A self resettable	
Max. Charging Current	<ul style="list-style-type: none"> • 12Vdc Configuration: 0.6A • 24Vdc Configuration: 0.3A 	
Max. Discharge Current	<ul style="list-style-type: none"> • 12Vdc Configuration: 5A • 24Vdc Configuration: 3A 	
CONFIGURATION		
Voltage / Capacity (Settable by external jumper)	<ul style="list-style-type: none"> • 12Vdc / 2.4Ah • 24Vdc / 1.2Ah 	
GENERAL DATA		
Operating temperature	- 20°C...+ 40°C (or according to battery limits)	
Protection degree	IP20 (EN60529)	
Battery Connectors	2.5mm ² , screw type pluggable (24...12AWG)	
Selection Mode Connectors	2.5mm ² , screw type pluggable (24...12AWG)	
Case material	Aluminum	
Weight	1.2kg (with 2 batteries included)	
Size (W x H x D)	54 x 115 x 110mm	

- Compact size, standard enclosure shape
- Reliable topology, based on new technology of Electric Double Layer Capacitors
- > 7.6kJ (2.1Wh) energy storage
- Replaces 12V batteries for short term backup applications
- Extended operating temperature for high reliability
- Multiple parallel and series connection possibilities for voltage and/or current increase
- Reverse polarity and overcurrent protections
- Pluggable connectors
- Up to 85°C operating temperature



For reference only

TECHNICAL DATA

NCP12

GENERAL DATA

Input DC rated voltage	Nominal: 12Vdc (range 0...16Vdc) ABSOLUTE MAXIMUM VOLTAGE: 16Vdc
Energy storage capacity	7.6kJ (2.1Wh)
Input current for capacitor charging	20A max.
Output current for capacitor discharging	20A / 30A for 5sec (see below discharging typical charts)
Charging time	(see below typical chart)
Protections	<ul style="list-style-type: none"> • Reverse polarity connection • Short circuit through 30A ATO blade, user replaceable
Operating temperature	- 40°C...+ 85°C
Voltage derating	- 120mV/°C over 65°C
Humidity	5...95% r.H. non condensing
Cooling	Natural convection
Charging/Discharging Cycles	500'000 @ 25°C
DC lifetime	10 years @ 25°C
DC bus / ground isolation	0.75kVdc
Safety standards	UL508 (reference), EN60950 (reference), CE marking
EMC Standards	EN61000-6-2, EN61000-6-3
Protection degree	IP20 (EN60529)
Connection terminals	2.5mm ² , screw type pluggable (24...12AWG)
Case material	Aluminum
Weight	0.75kg
Size (W x H x D)	80 x 120 x 100mm

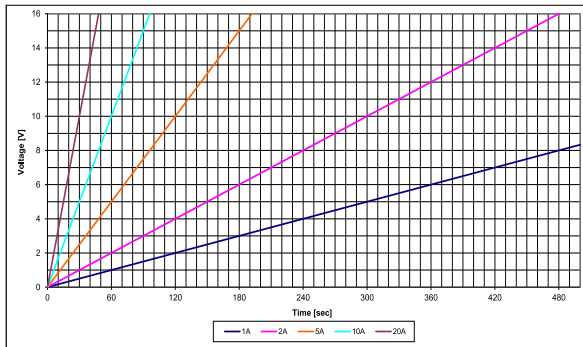

Constant Current Charging

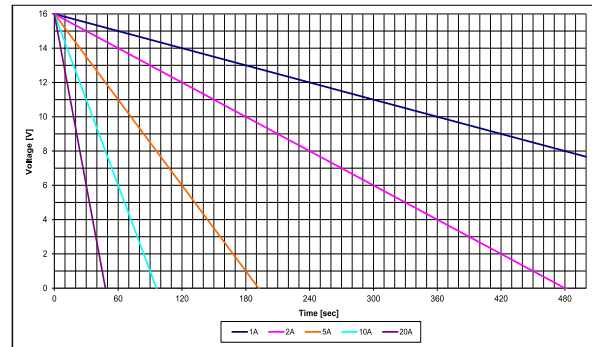

Constant Current Discharge

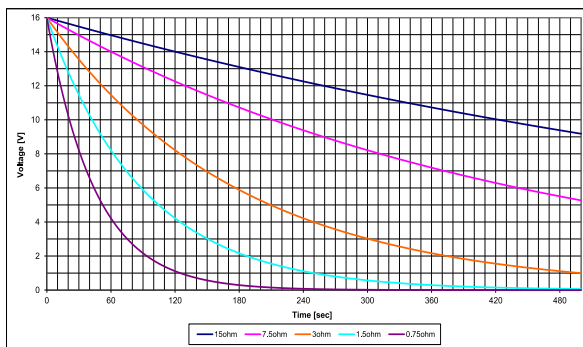

Constant Resistance Discharge

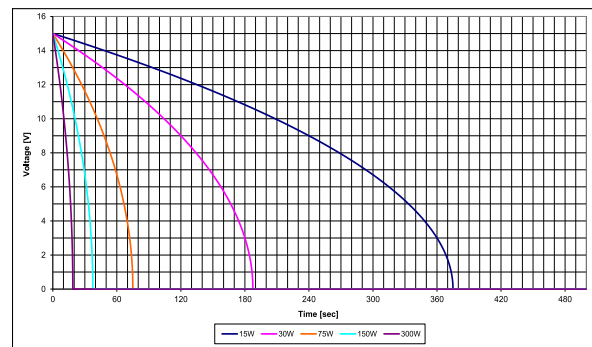

Constant Power Discharge

- Wide input voltage range: 12...85Vdc
- Extremely low loss - up to 99% efficiency
- Ultra Compact
- Output 20A
- Pluggable connectors
- Up to 70°C operating temperature with no derating

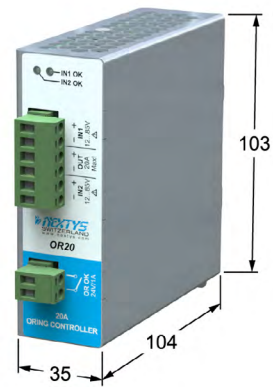

For reference only

TECHNICAL DATA

		<i>OR20</i>
OUTPUT DATA		
Rated voltage		12...85Vdc
Continuous current		20A
Peak output current		> 100A
Conduction resistance		< 9mΩ
INPUT DATA		
Input DC rated voltage		12...85Vdc
Input current		20A
Standby power		< 0.2W
Input protection	<ul style="list-style-type: none"> • Overvoltage ≥ 100V • Reverse polarity connection 	
USER INTERFACE		
Status signals	<ul style="list-style-type: none"> • IN1 OK - green LED • IN2 OK - green LED • Redundancy available when IN1 OK & IN2 OK simultaneously • OR OK - dry contact (NO, 1A / 24V) 	
GENERAL DATA		
Dissipated power		< 4W
Operating temperature		- 40°C...+ 70°C
Derating		No derating
Lifetime expectancy		354'655h (40.5 years) at 25°C ambient full load
Humidity		5...95% r.H. non condensing
Cooling		Natural convection
Overvoltage category		I
Pollution degree		2 (IEC60664-1)
Insulation enclosure to live parts		0.75 kVdc
Standards & Approvals		UL508 (reference), EN60950 (reference), CE marking
EMC Standards		EN61000-6-2, EN61000-6-4
Protection degree		IP20 (EN60529)
Connection terminals input/output		2.5mm ² , screw type pluggable (24...12AWG)
Connection dry contact signal		2.5mm ² , screw type pluggable (24...12AWG)
Case material		Aluminum
Weight		0.25kg
Size (W x H x D)		35 x 103 x 104mm

- Wide input voltage range: 12...85Vdc
- Extremely low loss - up to 99% efficiency
- Ultra Compact
- CPU controlled
- Output 50A
- Pluggable connectors
- Easy acknowledgment of the power supplies availability
- Current share status display eases sources balancing
- Up to 75°C operating temperature with no derating

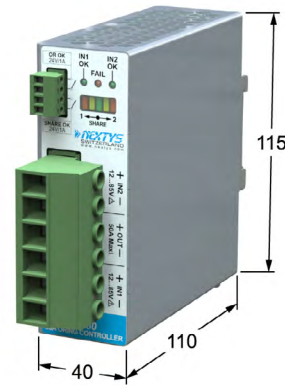

For reference only



TECHNICAL DATA

		<i>OR50</i>
OUTPUT DATA		
Rated voltage		12...85Vdc
Continuous current		50A
Peak output current		> 300A
Conduction resistance		< 4mΩ
INPUT DATA		
Input rated voltage		12...85Vdc
Input current		50A
Standby power		< 1.5W
Input protection	<ul style="list-style-type: none"> • Overvoltage ≥ 100V • Reverse polarity connection 	
USER INTERFACE		
Status signals	<ul style="list-style-type: none"> • IN1 OK - green LED • IN2 OK - green LED • FAIL - red LED (redundancy fail) • SHARE - bargraph current share • OR OK - dry contact 1A / 24V • SHARE OK - dry contact 1A / 24V 	
GENERAL DATA		
Dissipated power		< 10W
Operating temperature		- 40°C...+ 75°C (UL certified)
Derating		No derating
Lifetime expectancy		291'894h (33.3 years) at 25°C ambient full load
Humidity		5...95% r.H. non condensing
Cooling		Natural convection
Overvoltage category		I
Pollution degree		2 (IEC60664-1)
Insulation enclosure to live parts		0.75 kVdc
Standards & Approvals		UL508 (certified), EN60950 (reference), CE marking
EMC Standards		EN61000-6-2, EN61000-6-4
Protection degree		IP20 (EN60529)
Connection terminals input/output		Up to 16mm ² , screw type pluggable (20...6AWG)
Connection terminals signals		1.5mm ² , screw type pluggable (24...16AWG)
Case material		Aluminum
Weight		0.35kg
Size (W x H x D)		40 x 115 x 110mm

BATTMASTER®

We propose a high tech, low cost, compact battery monitoring system, easy to install and operate - first wireless on the market, aimed to replace legacy systems.

It is recommended for all applications where the operating costs are high and the failure of a battery can cause a critical damage.

For each monitored block or cell it measures and stores the battery voltage, temperature, current, internal resistance and discharging cycles for up to 1024 batteries/system.

The installation is a “Plug and Play” process, demanding no high level skills.

It can be integrated with any remote supervising system based on GSM, Internet or other communication means (e.g. Modbus).

It includes an integrated database, data backup and restore functionalities.

It presents an open structure designed to allow future extensions or customisations.

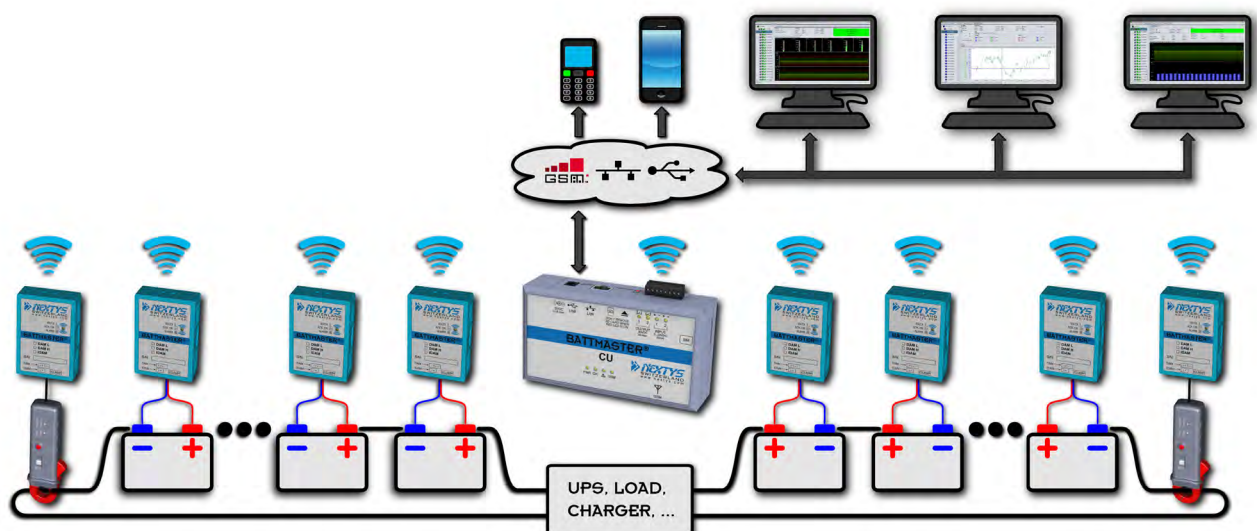



For reference only
CU



For reference only
DAM



For reference only
IDAM with Current Clamp

TECHNICAL DATA

CU		<i>Full version</i>	<i>Lite version</i>
Supply input voltage range	4.5...5.5Vdc by external power supply or by USB		
Current consumption	0.5A		
Backup power	2X AAA NiMh rechargeable batteries (about 1.5h of backup)		
Digital inputs	<ul style="list-style-type: none"> • 2 x opto isolated, 5...30Vdc, 10mA • Input 1: enables active Real Time Logging enables • Input 2: available for future use 		
Digital outputs	<ul style="list-style-type: none"> • 2 x relays, 30Vdc / 3A • Output 1: is closed if no alarm is ongoing, open otherwise • Output 2: available for future expansion 		
Data storage	FAT32 custom formatted microSD card, up to 4GB (> 2 years for 1'000 batteries at refresh rate 0.5h)		
Maximum number of supported devices	64 IDAM, 1024 DAM		64 IDAM, 50 DAM
Connectivity	Ethernet	<ul style="list-style-type: none"> • 10/100Mb • Used for remote configuration and monitoring • HTTP server and SMTP client 	
	Modbus/TCP	<ul style="list-style-type: none"> • Remote monitoring • Real Time Logging enable 	
	USB2	<ul style="list-style-type: none"> • Full speed 12Mbit/s • Used for remote configuration and monitoring 	
	GSM	<ul style="list-style-type: none"> • Quad-Band 850/900/1800/1900MHz • SMS alarms 	
	RF	<ul style="list-style-type: none"> • 868/915MHz license free ISM baseband (3 channels settable) • Up to 100 meters outdoor, up to 30 meters indoor 	
Weight	0.25Kg		
Size (W x H x D)	150 x 46 x 82mm		
DAM		<i>L type (2V batteries)</i>	<i>H type (6/12V batteries)</i>
Battery voltage range	1.5...5.5Vdc		5...18Vdc
Current consumption (typical)	80mA @ 2V		30mA
RF	<ul style="list-style-type: none"> • 868/915MHz license free ISM baseband (3 channels settable) • Up to 100 meters outdoor, up to 30 meters indoor 		
Battery Measurements	Voltage	1.5...5.5Vdc, ± 1.5%	
	Ri	1...300mΩ, ± 10% or ± 1mΩ	
Temperature sensor	Temperature	- 20°C...+ 80°C, ± 2°C	
		Internal (default) or using optional external sensor (P/N: 6040)	
Protections	<ul style="list-style-type: none"> • Reverse polarity (active) • Overvoltage (passive) 		
Battery connection	Blade connector (Faston), ring or alligator clip (others possible on demand)		
Weight	37g		
Size (W x H x D)	56 x 21 x 81mm		
IDAM		<i>Type 1 (300A)</i>	<i>Type 2 (600A)</i>
Supply input range	9...18Vdc (from external power supply or battery)		
Current consumption (typical)	50mA		
RF	<ul style="list-style-type: none"> • 868/915MHz license free ISM baseband (3 channels settable) • Up to 100 meters outdoor, up to 30 meters indoor 		
Current range	<ul style="list-style-type: none"> • 40A range: 0...40A, ± 1.5% or ± 0.4A • 300A range: 0...200A, ± 1.5% or ± 2A • 300A range: 200...300A, ± 2.4% or ± 3A 		<ul style="list-style-type: none"> • 100A range: 0...100A, ± 3% or ± 3A • 600A range: 0...400A, ± 3% or ± 4A • 600A range: 400...600A, ± 4% or ± 4A
	<ul style="list-style-type: none"> • Reverse polarity (active) • Overvoltage (passive) 		
	Weight	37g - (current clamp: 0.181kg)	
Size (W x H x D)	56 x 21 x 81mm - (current clamp: 47 x 185 x 31.5mm)		56 x 21 x 81mm - (current clamp: 60 x 202.6 x 27mm)

MOUNTING BRACKETS

We offer various DIN rail mechanical accessories as DIN rail fixing clamps and mounting adapters.

They can be used in conjunction with NEXTYS or other market products, according to various application needs.

DIN Rail Clamp

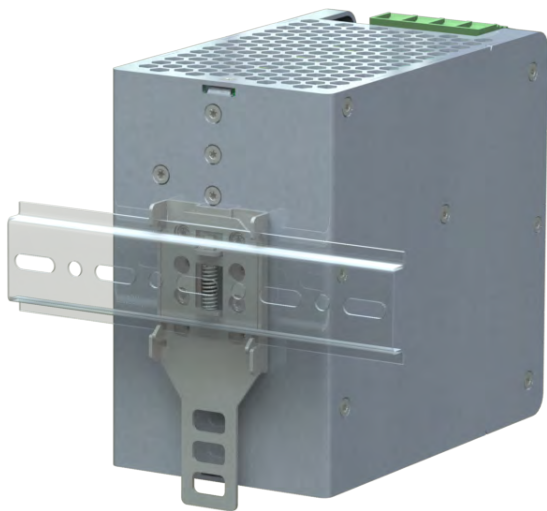

DIN-M



DIN-MS



DINC2



DINC35

Wall Mount Adapter

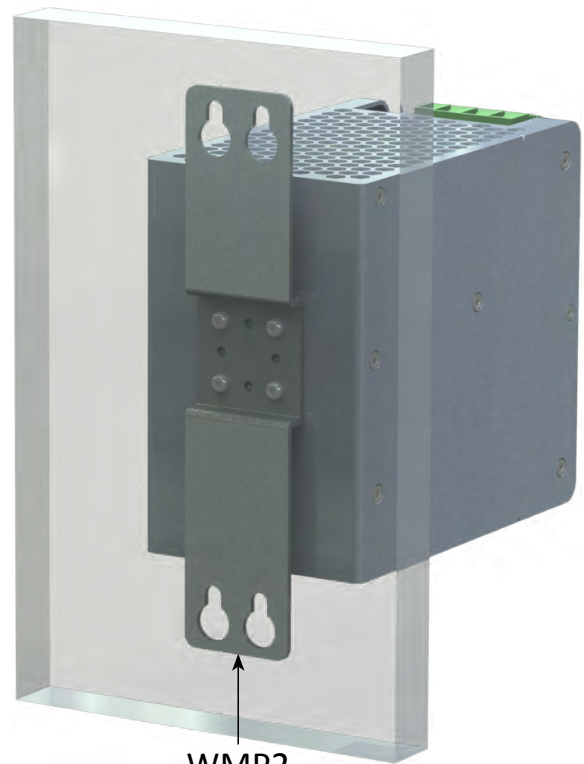

WMP2

MOUNTING BRACKETS



For reference only

DIN-M

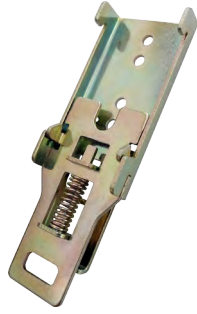

For reference only

DIN-MS



For reference only

DINC2



For reference only

DINC35



For reference only

WMP2

TECHNICAL DATA

DIN-M (DIN Rail Clamp)

Weight	20g
Size (W x H x D)	38 x 95.2 x 10.5mm

DIN-MS (DIN Rail Clamp)

Weight	15g
Size (W x H x D)	27 x 82 x 10.5mm

DINC2 (DIN Rail Clamp)

Weight	4g
Size (W x H x D)	22 x 45 x 8.3mm

DINC35 (DIN Rail Clamp)

Weight	10g
Size (W x H x D)	35 x 47.9 x 8.5mm

WMP2 (Wall Mount Adapter)

Weight	100g
Size (W x H x D)	38 x 180 x 9mm

Note: you can download the files with overall dimensions from "<http://www.nextys.com/mounting-brackets.html>".

FROM THE IDEA TO THE PRODUCT

We are a turn key, complete service provider in the electronics for R&D and manufacturing.

We can develop power and control solutions for the following specific fields:

- ✓ Industrial automation
- ✓ Railway
- ✓ Elevator
- ✓ Energy (low and medium voltage)
- ✓ Energy storage (battery management)
- ✓ Motor control
- ✓ Telecom
- ✓ Medical
- ✓ Residential and commercial market

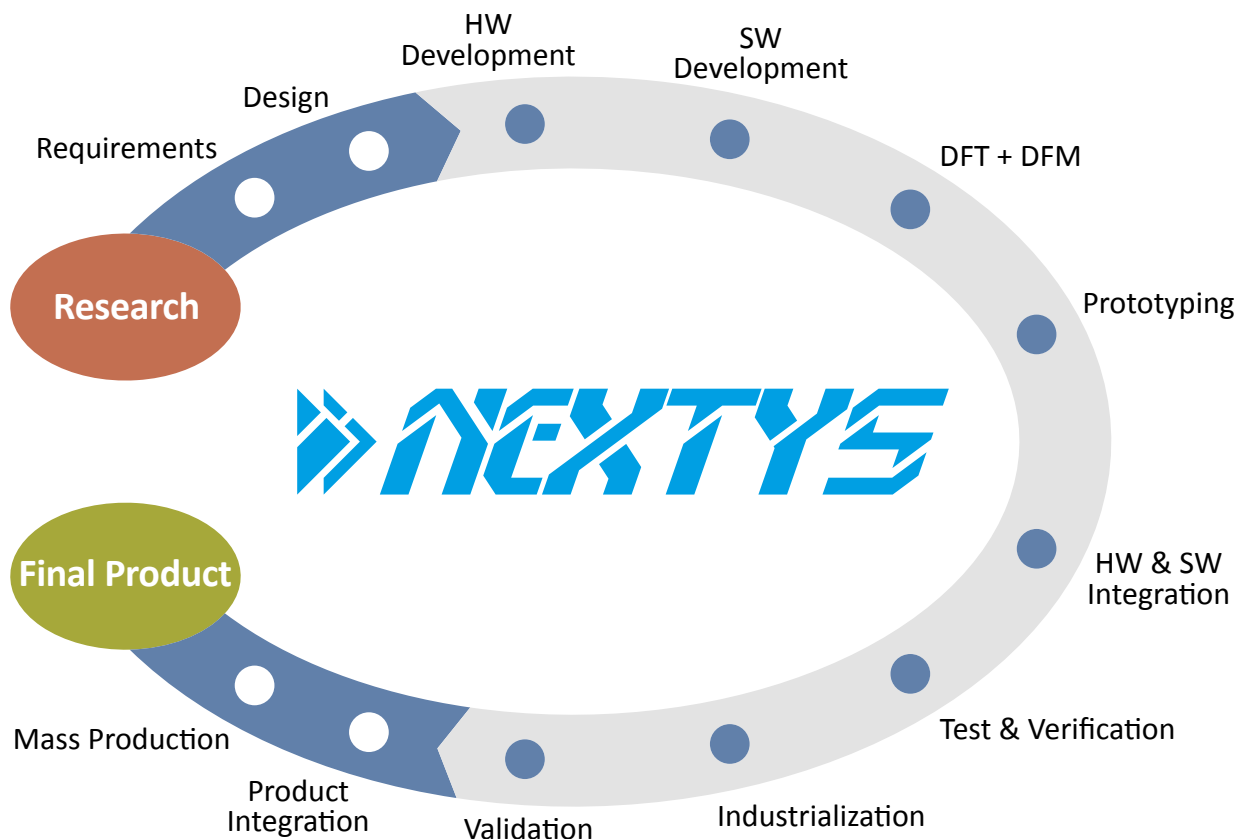

- Compact size
- 1.5kV isolation barrier
- Extreme versatility by pluggable connections
- Compliant to Modbus communication protocol
- Usable with common USB and RJ45 Ethernet Cables
- Compatible with products provided with RS-485
- Windows XP, Vista, Win-7, Win-8, Win-10 Compatible
- Suitable for **POWERMASTER** software



NEW



For reference only

TECHNICAL DATA

MODUS

GENERAL DATA

Power	Powered from PCs USB port
Operating temperature	- 40°C...+ 70°C
Storage temperature	- 40°C...+ 80°C
Humidity	5...95% r.H. non condensing
Overvoltage category	I
Pollution degree	2 (IEC60664-1)
Isolation voltage	1.5kVdc
Standards & Approvals	EN60950 (reference), CE marking
EMC Standards	EN61000-6-2, EN61000-6-3
Protection degree	IP20 (EN60529)
USB Connection	USB type B
RS-485 Connection	RJ45 Female
RS-485 Specification Parameters	<ul style="list-style-type: none"> • 2 wires Half Duplex interface • Baudrates: 300, 600, 1200, 1800, 2400, 4800, 7200, 9600, 14400, 19200, 38400, 57600, 115200 Bps • Start bits: 1 • Data bits: 7, 8 • Parity: None, even, odd, mark, space • Stop bits: 1, 2 • Flow control: Auto switching
Modbus Connections	<ul style="list-style-type: none"> • According to Modbus specification protocol over serial line • 2W-Modbus RJ45 Pin outs (Half duplex) • PIN4: D1 (B) • PIN5: D0 (A) • PIN8: GND
Case material	ABS, Flame retardant UL94 HB
Weight	45g
Size (W x H x D)	31.8 x 25.4 x 76.2mm



- Universal input DC BUS 24...110Vdc
- Braking current 50A
- CPU controlled
- Digital display interface
- User setttable braking threshold and hysteresis
- Various integrated protections
- Parallelable up to 4 units (8kW)



For reference only



TECHNICAL DATA

MBC2K	
GENERAL DATA	
DC BUS Voltage range	24...110Vdc
Maximum Braking current	50A for 1s
Brake activation voltage	27...106Vdc, threshold adjustable in 20 steps
Brake voltage hysteresis	3Vdc or 6Vdc settable
Protections	<ul style="list-style-type: none"> • Undervoltage on DC BUS $\leq 22Vdc$ • Overvoltage on DC BUS $\geq 110Vdc$ • Brake resistor overtemperature (if the temperature sensor is present) • Module internal overtemperature $> 90^{\circ}C$ ($194^{\circ}F$) • Brake resistor interrupted or not connected • Short circuit: braking current $> 80A$ • Overload: braking time $> 1s$
User interface	<ul style="list-style-type: none"> • 2 x 7 segment LED displays • ALARM - red LED • SET/RESET and MENU - 2 programming keys • Dry contact 1A / 24V
Parallel connection	Up to 4 units for increase a total braking power 8kW through synchronization bus (4 x 2kW braking resistors are needed)
Dissipated power	$< 20W$
Operating temperature	$- 40^{\circ}C...+ 70^{\circ}C$
Derating	No derating
Lifetime expectancy	291'894h (33.3 years) at $25^{\circ}C$ ambient full load
Overvoltage category	I
Pollution degree	2 (IEC60664-1)
Input / ground isolation	0.75kVdc
Standards & Approvals	<ul style="list-style-type: none"> • UL508 (reference) • EN60950 for SELV use up to 60Vdc • Using the MBC2K at voltages $> 60Vdc$ is not classifiable as SELV, CE marking
EMC Standards	EN61000-6-2, EN61000-6-3
Protection degree	IP20 (EN60529)
Connection input DC BUS + PE	2.5mm ² , screw type pluggable (24...12AWG)
Connection output brake resistor	2.5mm ² , screw type pluggable (24...12AWG)
Connection signals	1.5mm ² , screw type pluggable (24...16AWG)
Case material	Aluminum
Weight	0.35kg
Size (W x H x D)	40 x 115 x 110mm

- Compact solution for in-wall mounting for building automation
- Standard diameter $\varnothing 68\text{mm}$
- Very high overload capability - 400%

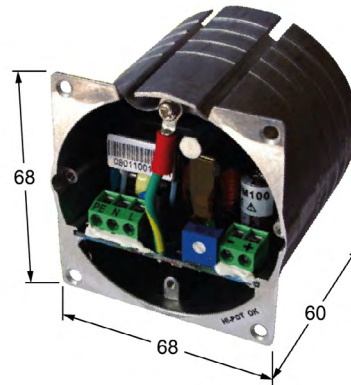

For reference only

TECHNICAL DATA

WM100-24

OUTPUT DATA

Rated voltage	24Vdc
Adj. output voltage range	23.5...27.5Vdc
Continuous current	1A
Overload limit	4A / 30s
Load regulation	$\leq 0.5\%$
Ripple and noise	$\leq 50\text{mVpp}$
Hold up time	$\geq 40\text{ms}$

Protections

- Overload/short circuit: hiccup mode
- Thermal protection
- Output overvoltage

INPUT DATA

Input AC rated voltage	Nominal: 240Vac (range 187...264Vac)
Frequency	47...63Hz
Input DC rated voltage	270...345Vdc
Input AC rated current	0.3A
Inrush peak current	$\leq 35\text{A}$
Internal protection fuse	Fuse 2AT (not user replaceable)
Recommended external protection	MCB 4A C curve / SPD

GENERAL DATA

Efficiency	$> 84\%$
Dissipated power	$< 5\text{W}$
Operating temperature	$- 20^{\circ}\text{C}...+ 45^{\circ}\text{C}$
Derating	No derating
Overvoltage category	III
Pollution degree	2 (IEC60664-1)
Input / output isolation	4.2kVdc
Input / ground isolation	2.2kVdc
Output / ground isolation	0.75kVdc
Standards & Approvals	EN60950 (certified), CE marking
EMC Standards	EN61000-6-1, EN61000-6-3
Protection degree	IP20 (EN60529 when mounted in wall)
Connection terminals	1.5mm ² , screw type header (24...12AWG)
Case material	Die cast aluminum
Weight	0.225kg
Size (W x H x D)	68 x 68 x 60mm

- Ultra compact in-wall USB Power Supply (< 22mm width)
- Developed according to USB standard
- Modular PCB can be assembled in various custom made enclosures

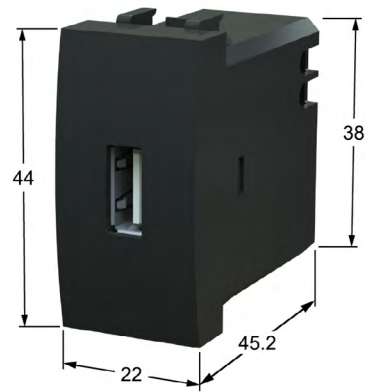

For reference only

TECHNICAL DATA

USW2A	
OUTPUT DATA	
Output voltage	5Vdc ±10%
Continuous current	1A
Overload limit	1.25A
Load regulation	≤ 2%
Ripple and noise	≤ 100mVpp
Hold up time	
Vin = 120Vac	≥ 25ms
Vin = 230Vac	≥ 80ms
Protections	Constant current at the overload limit with auto reset
INPUT DATA	
Input AC rated voltage	Nominal: 120...240Vac (range 90...264Vac)
Frequency	47...63Hz
Input DC rated voltage	110...345Vdc
Input AC rated current	
Vin = 120Vac	120mA
Vin = 230Vac	70mA
Input DC rated current	
Vin = 110Vdc	80mA
Vin = 345Vdc	40mA
Internal protection fuse	Fuse Resistor 10Ω (not user replaceable)
GENERAL DATA	
Efficiency	> 73%
Dissipated power	< 60mW
Operating temperature	- 20°C...+ 60°C
Storage Temperature	- 20°C...+ 85°C
Overvoltage category	II
Pollution degree	2 (IEC60664-1)
Input / output isolation	4.2kVdc
Standards & Approvals	UL508 (reference), EN60950 (reference), CE marking
EMC Standards	EN61000-6-1, EN61000-6-3
Protection degree	IP20 (EN60529)
Connection terminals	1.5mm ² , screw type header (24...12AWG)
Connection terminals output	USB-A female connector
Case material	ABS, Flame retardant UL94 V-0
Weight	25g
Size (W x H x D)	16.7 x 35.5 x 42mm (PCB dimension) To be hosted in a standard 22mm switch type housing



- High efficiency and compact size
- Wide input voltage range
- High operating temperature (up to 70°C)
- Designed according to EN50121 for railway application

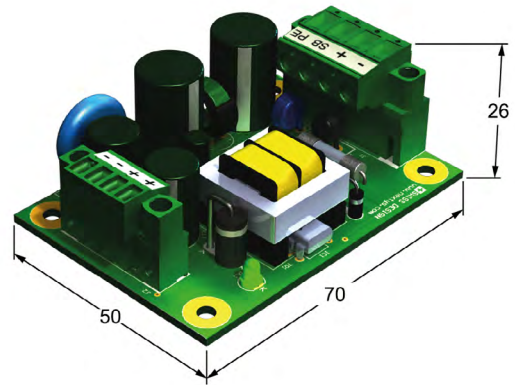

For reference only

TECHNICAL DATA

NPSR10-5	
OUTPUT DATA	
Rated voltage	5.1Vdc
Adj. output voltage range	5.1Vdc Fixed
Continuous current	2A
Overload limit	2.5A
Load regulation	≤ 0.5%
Ripple and noise	≤ 100mVpp
Hold up time	≥ 50ms
Protections	<ul style="list-style-type: none"> • Overload/short circuit: hiccup mode • Thermal protection • Output overvoltage • Input undervoltage lockout (UVLO 64Vdc ±2V)
Status signals	DC OK - green LED
Parallel connection	Possible for redundancy (with external ORing module)
INPUT DATA	
Input DC rated voltage	Nominal: 110Vdc (range 66...154Vdc)
Input DC rated current	0.3A
Inrush peak current	≤ 5A
Internal protection fuse	Fuse 0.8AT (not user replaceable)
GENERAL DATA	
Efficiency	> 78%
Dissipated power	< 3W
Operating temperature	- 40°C...+ 85°C (+ 85°C at full load for 10min max.)
Derating	- 0.13W/°C over 70°C
Humidity	5...95% r.H. non condensing
Overvoltage category	I
Pollution degree	2 (IEC60664-1)
Input / output isolation	2.2kVdc
Input / ground isolation	1.5kVdc
Output / ground isolation	0.71kVdc
Standards & Approvals	EN50121 (certified), CE marking
EMC Standards	EN50121-3-2
Connection terminals input	2.5mm ² , screw type pluggable (24...14AWG)
Connection terminals output	1.5mm ² , screw type pluggable (26...16AWG)
Weight	65g
Size (W x H x D)	50 x 26 (28) x 70mm (PCB dimension)

CKMC5 - DIN Rail Ultracompact Motor Soft-start

- High efficiency and compact size - 7.7mm width
- Plastic enclosure
- Class II insulation (simplified wiring)
- Optimal for cost saving rating of power supply with dynamic loads
- Allows to operate high inrush current loads
- Suitable for loads where a power regulation is necessary (e.g. motors)
- Power level and soft-start duration are adjustable through 2 user settable potentiometers
- PWM (Pulse Width Modulation) technique

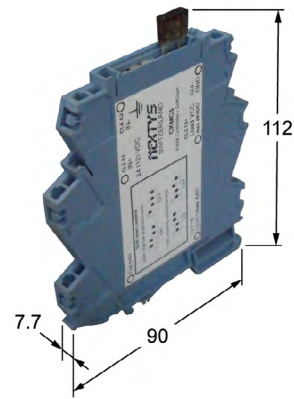

**ULTRA
COMPACT**



For reference only

TECHNICAL DATA

CKMC5	
OUTPUT DATA	
Output voltage	12...30Vdc
Continuous current	4A
Overload limit	6A max. for 30s
Soft-start duration	<ul style="list-style-type: none"> • Adjustable 0.5...5s with potentiometer • Adjustable with external potentiometer (5kΩ)
Power level range	Adjustable 0 - 100% with potentiometers
Protections (load side)	<ul style="list-style-type: none"> • Short circuit (ATO fuse) • Reverse polarity • Transient overvoltage
INPUT DATA	
Input voltage for control side	12Vdc (factory set) or 24Vdc
GENERAL DATA	
Operating temperature	- 20°C...+ 45°C
Overvoltage category	I
Pollution degree	2 (IEC60664-1)
Input / output protection	0.75kVdc
Standards & Approvals	CE marking
Protection degree	IP20 (EN60529)
Connection terminals	2.5mm ² , spring clamp terminal (26...14AWG)
Case material	PA, Flame retardant UL94 V-0
Weight	0.1kg
Size (W x H x D)	7.7 x 112 x 90mm
BLOCK DIAGRAM	

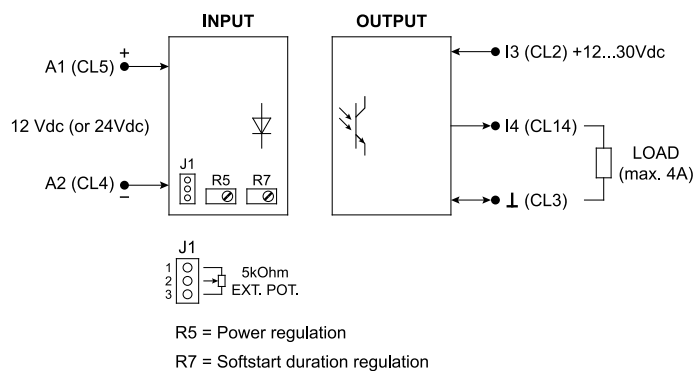

GLOSSARY

- **AC** : Alternate Current
- **BMS** : Battery Monitoring System
- **C.C.** : Constant Current
- **C.V.** : Constant Voltage
- **CPU** : Central Processing Unit (microprocessor)
- **DC** : Direct Current
- **DFM** : Design For Manufacturing
- **DFT** : Design For Testing
- **EMC** : Electro Magnetic Compatibility
- **HW** : Hardware
- **MCB (Fuse)** : Miniature Circuit Breaker
- **OVLO** : Over Voltage Lock-Out
- **PFC** : Power Factor Corrector
- **PWM** : Pulse Width Modulation
- **SMPS** : Switched Mode Power Supply
- **SPD** : Surge Protective Device
- **SW** : Software
- **UPS** : Uninterruptible Power Supply
- **UVLO** : Under Voltage Lock-Out
- **VDR** : Voltage Dependent Resistor (Varistor)



OFFICE, WAREHOUSE AND EMC LAB
Via Luserte Sud 6
6572 Quartino
Switzerland

Directions:

- From **A2/E35** highway (any direction)
- Use "**Exit 47**" - **Bellinzona Sud** towards **Locarno**
- Continue for about 6.5Km, exit to **Luserte Sud**

Driving time:

- 1.5h from **Milan airports**
- 0.5h from **Lugano**

On our Web site you will be able to find:

- the latest news on our products
 - the updated data sheets
 - various application notes
 - download application software
 - update the products firmware
 - webshop
 - find where to buy our products
- ... and much more!!



www.nextys.com





Via Luserte Sud 6, 6572 Quartino
SWITZERLAND

☎ +41-(0)91 - 840 14 46 / 8

📠 +41-(0)91 - 840 14 47

General inquiries: info@nextys.com
Sales: sales@nextys.com

Distributor