

Accessories

Meeting all needs

Mechanical accessories

from Page A-4

- *Brackets for sensors*
- *Brackets for VISOR® and illumination*



Optical accessories

from Page A-20

- *Reflectors and reflective tape*
- *Lenses and protective casings*
- *Illumination*



A sensor rarely comes unaccompanied: accessories supporting their mounting, commissioning and use are of considerable importance for the reliable functioning of an automation solution. The characteristic practical orientation of SensoPart products is thus also evident in a particularly versatile and user-friendly range of accessories. In this section they are divided into categories: mechanical, optical and electrical accessories.

The mechanical accessories include everything that is involved in mounting and protecting the sensor: mounting brackets, blocks, rods and rails, brackets with protective hoops, stainless steel casings for hygienic areas and many others. All accessories are extremely robust and designed to meet practical demands. We thus offer clever, sometimes patented, detailed solutions that greatly simplify the mounting and fine adjustment of sensors, particularly in difficult locations, such as dovetail mountings or rotatable brackets.

Optical accessories include lenses as well as protective casings, external illumination such as ring and surface lights, and reflectors of differing designs, shapes and sizes. All SensoPart lenses offer high optical quality. We offer C-mount lenses as an alternative to integrated lenses especially for vision sensors when, for example, very high measurement distances are required.

Our electrical accessories include a great variety of cables and adapters, power supply units and switching devices, as well as interface components for the integration of supplementary functions. One example of the latter category is the SmartPlug – very popular amongst users – which expands switching sensors with logic and control functions such as counters, timing elements, inverters or frequency converters. The SmartPlug is simply plugged in between the sensor and the cable – a brilliant little product that is only available from SensoPart!

Electrical accessories from Page A-38

- Cables
- Converters
- Power supply units, switching devices and Panel Viewer

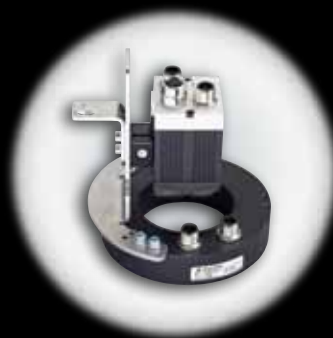

Flexible: MG 3A Mounting angle with 2 axes and drilled hole for mounting rod.



Practical: sensors can be comfortably and precisely aligned after mounting with the help of rod brackets.



Versatile: SensoPart offers a comprehensive selection of reflectors and reflective tape: rectangular, square or round.











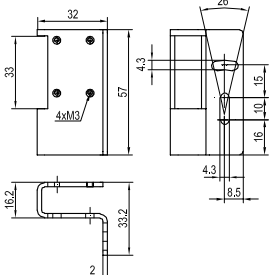

Robust: all mounting and bracket elements are extremely stable and offer additional protection for sensors when necessary.

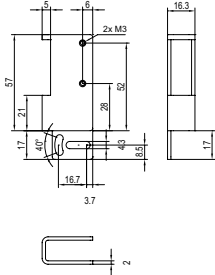
Accessories – Product Overview	
	Page
Mechanical accessories	A-4
Brackets for sensors	A-4
Brackets for VISOR® and illumination	A-14
Optical accessories	A-20
Reflectors and reflective tape	A-20
Lenses and protective casings	A-27
Illumination	A-29
Electrical accessories	A-38
Cables	A-38
Converters	A-42
Power supply units, switching devices and Panel Viewer	A-43

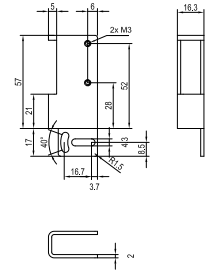
Brackets for F 25, F 20, UT 20, FL 20 series (Cont.)			
		153-01155	Part number / Article number
			Description
			MBD F 25ST2 / 661-01005
			Clamping bracket for \varnothing 12 mm mounting rod and 10 x 10 mm square profile, with M4 screw and M3 nut
			Material: die-cast zinc
			Suitable for
			F 25
		153-01155	Part number / Article number
			Description
			Set: MBD F 25STP / 661-01004
			Clamping bracket for \varnothing 12 mm mounting rod and 10 x 10 mm square profile, with protective casing, M4 screw, M4 thumbscrew, M4 nut, 2x M3 screw
			Material: die-cast zinc
			Casing Material: stainless steel V2A
			Suitable for
			F 25
		153-01164	Part number / Article number
			Description
			MB ST2 / 661-01007
			Mounting component for \varnothing 12 mm mounting rod and 10 x 10 mm square profile, and F 55 and fork sensors (FGL), with M4 screw
			Material: die-cast zinc
			Suitable for
			F 55, FGL, MST 45-20, MST 45-30, MST 45-40
		153-01017	Part number / Article number
			Description
			MSP F 20-11 / 558-41006
			Protective sensor angle bracket with screws, very robust
			Material: stainless steel V2A
			Suitable for
			F 20 UT 20-150
			F 25 UT 20-S150
			FL 20 UT 20-240
		153-00296	Part number / Article number
			Description
			MSP F 20-1 / 558-41004
			Protective sensor angle bracket with screws, very robust
			Material: stainless steel V2A
			Suitable for
			F 20
			F 25
			UT 20
			FL 20
		153-00908	Part number / Article number
			Description
			MSP F 20-23 / 558-41011
			Protective sensor angle bracket with screws, very robust
			Material: stainless steel V2A
			Suitable for
			F 20
			F 25
			UT 20
			FL 20

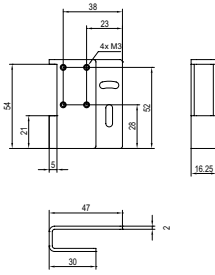
Accessories

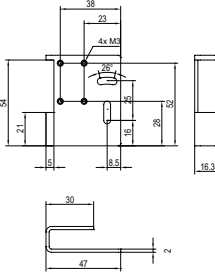
Brackets

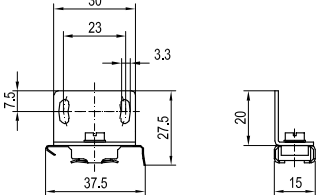
Brackets for F 20, F 25, UT 20, FL 20 series (Cont.)			
		<p>Part number / Article number 153-00297</p> <p>Description</p> <p>Suitable for</p>	<p>MSP F 20-2 / 558-41005</p> <p>Protective sensor angle bracket with screws, very robust Material: stainless steel V2A</p> <p>F 20 UT 20-150 F 25 UT 20-S150 FL 20 UT 20-240</p>
		<p>Part number / Article number 153-00973</p> <p>Description</p> <p>Suitable for</p>	<p>MSP F 20-13 / 558-41008</p> <p>Protective sensor angle bracket with screws, very robust Material: stainless steel V2A</p> <p>F 20 UT 20-150 F 25 UT 20-S150 FL 20 UT 20-240</p>
		<p>Part number / Article number 153-00972</p> <p>Description</p> <p>Suitable for</p>	<p>MSP F 20-12 / 558-41007</p> <p>Protective sensor angle bracket with screws, very robust Material: stainless steel V2A</p> <p>F 20 UT 20-150 F 25 UT 20-S150 FL 20 UT 20-240</p>
		<p>Part number / Article number 153-00974</p> <p>Description</p> <p>Suitable for</p>	<p>MSP F 20-21 / 558-41009</p> <p>Protective sensor angle bracket with screws, very robust Material: stainless steel V2A</p> <p>F 20 UT 20-150 F 25 UT 20-S150 FL 20 UT 20-240</p>
		<p>Part number / Article number 153-00975</p> <p>Description</p> <p>Suitable for</p>	<p>MSP F 20-22 / 558-41010</p> <p>Protective sensor angle bracket with screws, very robust Material: stainless steel V2A</p> <p>F 20 UT 20-150 F 25 UT 20-S150 FL 20 UT 20-240</p>
		<p>Part number / Article number 153-00291</p> <p>Description</p> <p>Suitable for</p>	<p>MS F 20-DIN / 558-41001</p> <p>DIN rail mounting with screws Material: nickel-plated steel</p> <p>FL 20</p>

Brackets for F 20, F 25, UT 20, FL 20 series (Cont.)			
		<p>153-01040</p> <p>Part number / Article number</p> <p>Description</p> <p>Suitable for</p>	<p>MZ F 25 / 661-01003</p> <p>Mounting adapter for FT 25 contrast sensors with horizontal or vertical light exit options, with screws</p> <p>Material: stainless steel V2A</p> <p>FT 25-W...-KL4</p> <p>FT 25-RGB...-KL4</p>
Brackets for F 50, F 55, F 80, F 88, FGL series			
		<p>153-01164</p> <p>Part number / Article number</p> <p>Description</p> <p>Suitable for</p>	<p>MB ST2 / 661-01007</p> <p>Mounting component for Ø 12 mm mounting rod and 10 x 10 mm square profile, and F 55 and fork sensors (FGL), with M4 screw</p> <p>Material: die-cast zinc</p> <p>F 55, FGL, MST 45-20, MST 45-30, MST 45-40</p>
		<p>153-00065</p> <p>Part number / Article number</p> <p>Description</p> <p>Suitable for</p>	<p>MS F 50 / 579-50000</p> <p>Angle bracket with screws</p> <p>Material: stainless steel VA</p> <p>F 50</p> <p>F 55</p> <p>F 80</p>
		<p>153-00298</p> <p>Part number / Article number</p> <p>Description</p> <p>Suitable for</p>	<p>MSP F 50 / 579-50005</p> <p>Protective sensor angle bracket with screws, very robust, light exit possible on three sides</p> <p>Material: stainless steel VA</p> <p>F 50</p>
		<p>153-01018</p> <p>Part number / Article number</p> <p>Description</p> <p>Suitable for</p>	<p>MP F 50 / 579-50003</p> <p>Adapter plate</p> <p>Material: galvanised steel plate</p> <p>F 50</p> <p>F 55</p>
		<p>153-00818</p> <p>Part number / Article number</p> <p>Description</p> <p>Suitable for</p>	<p>MS F 55 / 579-50010</p> <p>Angle bracket with screws</p> <p>Material: stainless steel V2A</p> <p>F 50</p> <p>F 55</p>

Accessories

Brackets

Brackets for fibre-optic cables and round housings







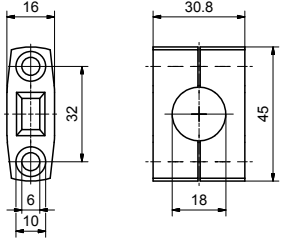
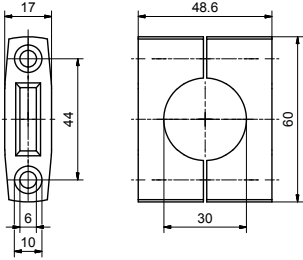
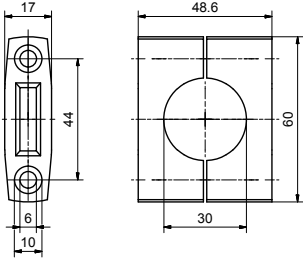

<p>153-00193</p>	<p>Part number / Article number</p> <p>Description</p> <p>Suitable for</p>	<p>MB 3,5 / 903-50313</p> <p>Mounting block / fibre mount, closed curve</p> <p>Material: nickel-plated brass</p> <p>Fibre-optic cables</p>
<p>153-00234</p>	<p>Part number / Article number</p> <p>Description</p> <p>Suitable for</p>	<p>MB 4,5 / 903-50314</p> <p>Mounting block / fibre mount, open curve</p> <p>Material: nickel-plated brass</p> <p>Fibre-optic cables</p>
<p>153-00194</p>	<p>Part number / Article number</p> <p>Description</p> <p>Suitable for</p>	<p>MB 6 / 903-05139</p> <p>Mounting block / fibre mount, open curve</p> <p>Material: nickel-plated brass</p> <p>Fibre-optic cables</p>
<p>153-00195</p>	<p>Part number / Article number</p> <p>Description</p> <p>Suitable for</p>	<p>MB 7 / 903-05140</p> <p>Mounting block / fibre mount, open curve</p> <p>Material: nickel-plated brass</p> <p>Fibre-optic cables</p>
<p>153-00235</p>	<p>Part number / Article number</p> <p>Description</p> <p>Suitable for</p>	<p>MB 8 / 903-05141</p> <p>Mounting block / fibre mount, open curve</p> <p>Material: nickel-plated brass</p> <p>Fibre-optic cables, round M8 housings</p>
<p>153-00236</p>	<p>Part number / Article number</p> <p>Description</p> <p>Suitable for</p>	<p>MB 10 / 903-05142</p> <p>Mounting block / fibre mount, open curve</p> <p>Material: nickel-plated brass</p> <p>Fibre-optic cables, round M10 housings</p>

Brackets for fibre-optic cables and round housings (Cont.)			
		<p>153-00196</p> <p>Part number / Article number</p> <p>Description</p> <p>Suitable for</p>	<p>MB 12 / 903-05143</p> <p>Mounting block / fibre mount, closed curve</p> <p>Material: nickel-plated brass</p> <p>Fibre-optic cables, round M12 housings</p>
		<p>153-00559</p> <p>Part number / Article number</p> <p>Description</p> <p>Suitable for</p>	<p>MC 08 / 041-01306</p> <p>Mounting angle for round housings</p> <p>Material: aluminium</p> <p>Round M8 housings</p>
		<p>153-00558</p> <p>Part number / Article number</p> <p>Description</p> <p>Suitable for</p>	<p>MA 12 / 041-01305</p> <p>Mounting angle for round housings</p> <p>Material: aluminium</p> <p>Round M12 housings</p>
		<p>153-00015</p> <p>Part number / Article number</p> <p>Description</p> <p>Suitable for</p>	<p>MA 18 / 041-01304</p> <p>Mounting angle for round housings</p> <p>Material: aluminium</p> <p>Round M18 housings</p>
		<p>153-00017</p> <p>Part number / Article number</p> <p>Description</p> <p>Suitable for</p>	<p>MA 30 / 041-01303</p> <p>Mounting angle for round housings</p> <p>Material: aluminium</p> <p>Round M30 housings</p>

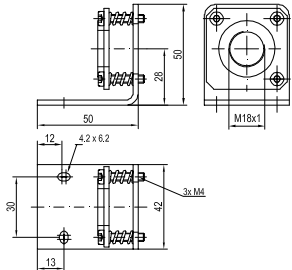
Accessories

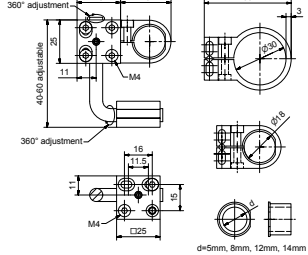

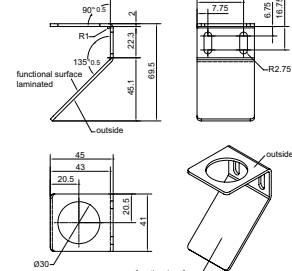

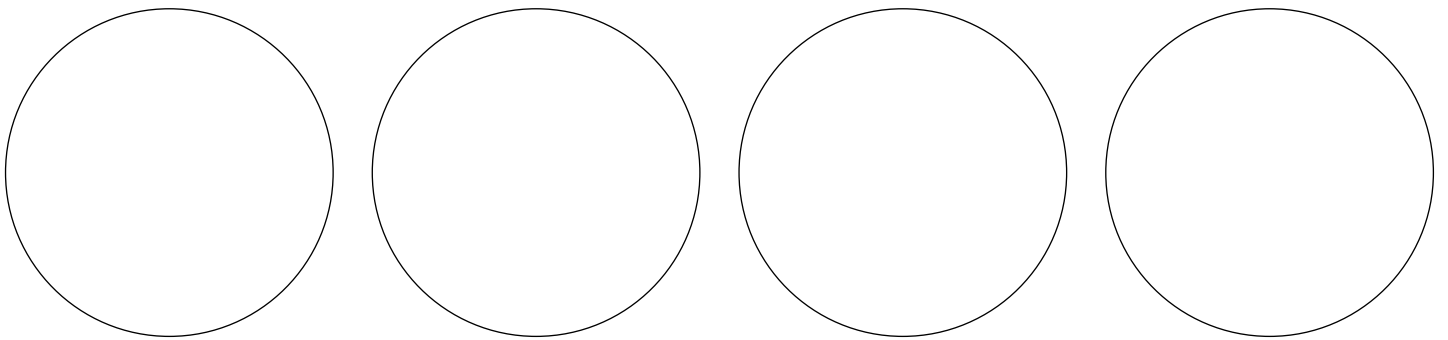



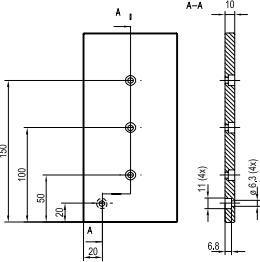

Brackets

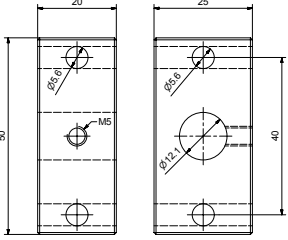
Brackets for fibre-optic cables and round housings (Cont.)				
		153-00016	Part number / Article number	MC 18 / 042-01528
		Description Suitable for	Retaining clip for round housings Material: plastic Round M18 housings	
		153-00018	Part number / Article number	MC 30 / 042-01527
		Description Suitable for	Retaining clip for round housings Material: plastic Round M30 housings	
		153-00059	Part number / Article number	MA 18 A / 042-12825
		Description Suitable for	Universal mounting angle for round housings, fine-adjustable with adjusting screws Material: galvanised steel Round M12 and M18 housings	
		153-01016	Part number / Article number	MS M5-30 / 558-41012
		Description Suitable for	Universal bracket for round housings Material: connecting rod, metal / mounting elements, plastic Round M5, M8, M12, M14, M18 and M30 housings	
		153-00959	Part number / Article number	Deflection mirror / 691-51535
		Description Suitable for	Deflection mirror for ultrasonic sensors Material: stainless steel UMT 30-350 UMT 30-1300	

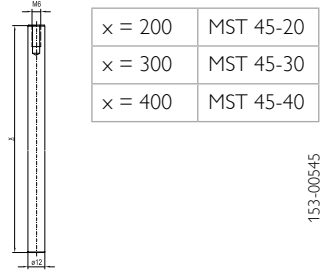

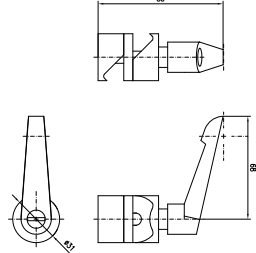
Accessories

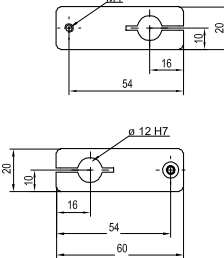
Brackets

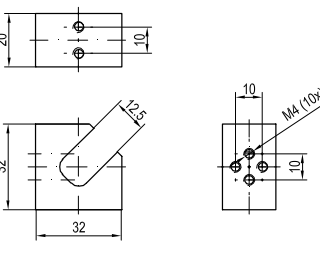
Brackets for V10,V20			
		<p>153-00547</p> <p>Part number / Article number</p> <p>Description</p> <p>Suitable for</p>	<p>MP 45 / 543-11003</p> <p>Mounting plate for mounting rod Material: anodised aluminium</p> <p>MST 45-xx</p>
		<p>153-01000</p> <p>Part number / Article number</p> <p>Description</p> <p>Suitable for</p>	<p>MB ST1 / 661-01002</p> <p>Mounting for mounting rod with clamping screw Material: aluminium</p> <p>MST 45-20 MST 45-30 MST 45-40</p>
		<p>153-00545</p> <p>Part number / Article number</p> <p>Description</p> <p>Suitable for</p>	<p>MST 45-20 / 543-11005 MST 45-30 / 543-11006 MST 45-40 / 543-11007</p> <p>Mounting rod with M6 internal thread Material: stainless steel</p> <p>MP 45, MB ST 1, MG 45, MB 45, MZ 45</p>
		<p>153-00776</p> <p>Part number / Article number</p> <p>Description</p> <p>Suitable for</p>	<p>MG 45 / 543-11008</p> <p>Mounting clamp for mounting rod Material: anodised aluminium, steel screw with plastic handle</p> <p>MST 45-xx</p>
		<p>153-00546</p> <p>Part number / Article number</p> <p>Description</p> <p>Suitable for</p>	<p>MZ 45 / 543-11004</p> <p>Intermediate mounting piece for mounting rod Material: anodised aluminium</p> <p>MST 45-xx</p>
		<p>153-00481</p> <p>Part number / Article number</p> <p>Description</p> <p>Suitable for</p>	<p>MB 45 / 543-11002</p> <p>Mounting block for mounting rod Material: anodised aluminium</p> <p>MST 45-xx MA 45 MA 45 L</p>

Brackets for V10, V20 (Cont.)				
		153-00482	Part number / Article number	MA 45 / 543-11001
			Description	Mounting angle Material: stainless steel V2A
		153-00600	Part number / Article number	MA 45 L / 543-11013
			Description	Mounting angle, long Material: stainless steel V2A
		153-00480	Part number / Article number	MK 45 / 543-11000
			Description	Mounting clamp, dovetail Material: anodised aluminium Screw: steel
		153-00901	Part number / Article number	MK 45 L / 543-11021
			Description	Mounting clamp, dovetail, long Material: anodised aluminium, Screw: steel
		153-00913	Part number / Article number	MG 2A / 543-11023
			Description	Mounting angle with 2 axes Material: anodised aluminium
		153-01181	Part number / Article number	MG 3A / 543-11024
			Description	Mounting angle with 2 axes and drilled hole for mounting rod Material: anodised aluminium
		153-01181	Part number / Article number	MG 3A / 543-11024
			Description	Mounting angle with 2 axes and drilled hole for mounting rod Material: anodised aluminium
		153-01181	Part number / Article number	MG 3A / 543-11024
			Description	Mounting angle with 2 axes and drilled hole for mounting rod Material: anodised aluminium
		153-01181	Part number / Article number	MG 3A / 543-11024
			Description	Mounting angle with 2 axes and drilled hole for mounting rod Material: anodised aluminium

Accessories



Brackets

Brackets for V10,V20 (Cont.)			
		<p>Part number / Article number</p> <p>Description</p> <p>Suitable for</p>	<p>LPT W50 / 527-51135</p> <p>Spark protection V10/V20 Material: anodised aluminium incl. front screen, glass</p> <p>V10 / V20</p>
		<p>Part number / Article number</p> <p>Description</p> <p>Suitable for</p>	<p>LPT S5 / 527-51136</p> <p>Replacement front screen, set of 5 pcs for LPT W50 Material: glass</p> <p>LPT W50</p>
		<p>153-00435</p>	
Brackets for illumination			
		<p>Part number / Article number</p> <p>Description</p> <p>Suitable for</p>	<p>MC 60 / 042-12820</p> <p>Retaining clip for mounting fluorescent tube Material: plastic</p> <p>LZS neon tubes</p>
		<p>Part number / Article number</p> <p>Description</p> <p>Suitable for</p>	<p>MA LR-18/112 / 543-11016</p> <p>Angle bracket for lighting, Ø 18 mm Length: 112 mm Material: nickel-plated steel</p> <p>LR 32 x-24-KFL5 LD 50 xD-24-KFL5</p>

Brackets for illumination (Cont.)			
		<p>153-00721</p> <p>Part number / Article number</p> <p>Description</p> <p>Suitable for</p>	<p>MA LR-23/112 / 543-11019</p> <p>Angle bracket for lighting, Ø 23 mm Length: 112 mm Material: nickel-plated steel</p> <p>LR 56 x-24-KFL5 LR 70 xD-24-KFL5 LR 70 xID-24-KFL5</p>
		<p>153-00722</p> <p>Part number / Article number</p> <p>Description</p> <p>Suitable for</p>	<p>MA LR-26/112 / 543-11017</p> <p>Angle bracket for lighting, Ø 26 mm Length: 112 mm Material: nickel-plated steel</p> <p>LR 50 xW-24-KFL5 LR 70 x-24-KFL5</p>
		<p>153-00723</p> <p>Part number / Article number</p> <p>Description</p> <p>Suitable for</p>	<p>MA LR-50/112 / 543-11018</p> <p>Angle bracket for lighting, Ø 50 mm Length: 112 mm Material: nickel-plated steel</p> <p>LR 74 xW-24-KFL5 LR 75 xI-24-KFL5 LR 90 xW-24-KFL5 LR 100 xID-24-KFL5</p>
		<p>153-00724</p> <p>Part number / Article number</p> <p>Description</p> <p>Suitable for</p>	<p>MA LR-100/112 / 543-11015</p> <p>Angle bracket for lighting, Ø 100 mm Length: 112 mm Material: nickel-plated steel</p> <p>LR 100 xD-24-KFL5 LR 130 xI-24-KFL5 LR 132 xW-24-KFL LFR 115 xD-24-2L12 LFR 45 xD</p>
		<p>153-01108</p> <p>V10, V20</p> <p>Mounting clamp, dovetail, long MK 45 L / 543-11021</p> <p>Angle bracket for lighting: MA LR-100/112 / 543-11015 MA LR-18/112 / 543-11016 MA LR-26/112 / 543-11017 MA LR-50/112 / 543-11018 MA LR-23/112 / 543-11019</p> <p>Mounting angle with 2 axes MG 2A / 543-11023</p>	

Accessories

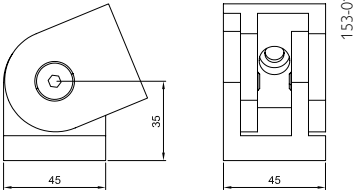
Brackets

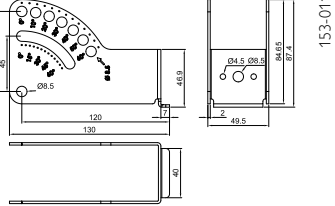
Brackets for light strips, High Power, LBxxx			
		<p>Part number / Article number</p> <p>Description</p> <p>Suitable for</p>	<p>MG LB L / 543-11025</p> <p>Mounting clamp light strip long Material: nickel-plated steel</p> <p>Light strips High Power, LBxxx</p>
		<p>Part number / Article number</p> <p>Description</p> <p>Suitable for</p>	<p>MG LB LL / 543-11026</p> <p>Mounting angle light strip long, lite Material: anodised aluminium</p> <p>Light strips High Power, LBxxx</p>

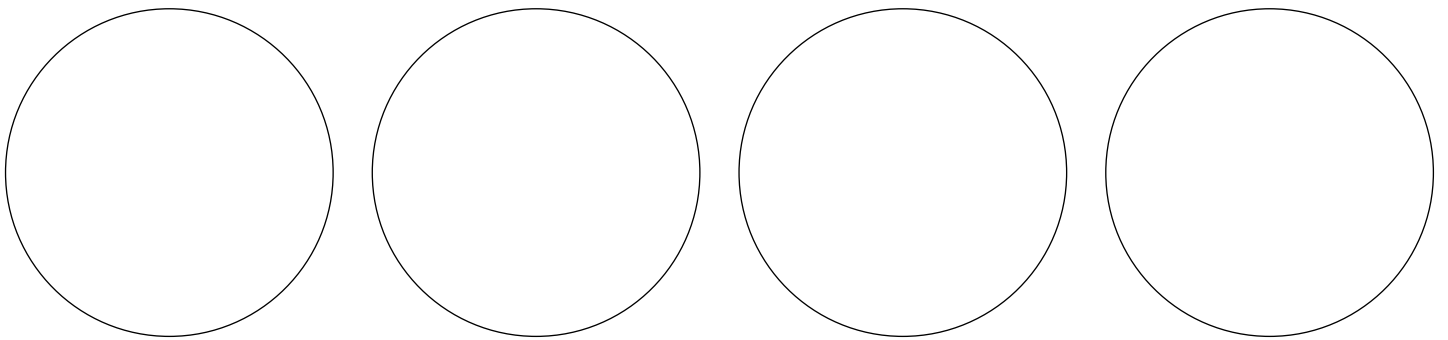

Accessories

Reflectors









- Reflectors
- Lenses / Protective casings
- Illumination



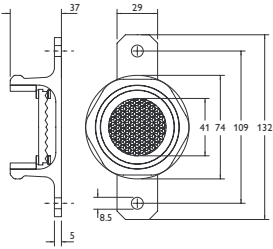

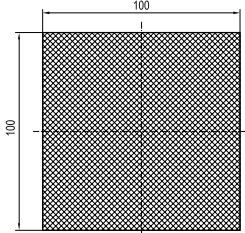
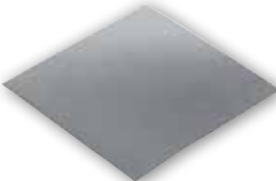
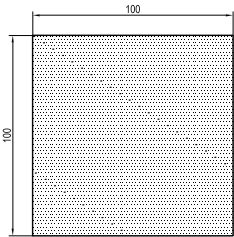

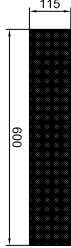

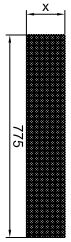

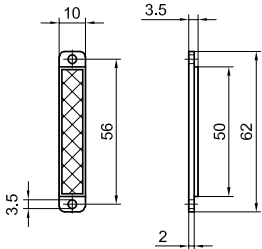
Reflectors for LED Retroreflective photoelectric sensor			
		<p>153-00068</p> <p>Part number / Article number</p> <p>Description</p> <p>Dimensions</p> <p>Mounting</p> <p>Temperature range</p> <p>Suitable for</p>	<p>R1 / 904-51532</p> <p>Reflector in housing</p> <p>19 x 73 x 8 mm</p> <p>2 mounting holes M3</p> <p>-20 ... +60 °C</p> <p>Retroreflective photoelectric sensor (LED)</p>
		<p>153-00069</p> <p>Part number / Article number</p> <p>Description</p> <p>Dimensions</p> <p>Mounting</p> <p>Temperature range</p> <p>Suitable for</p>	<p>R5 / 904-51533</p> <p>Reflector in housing</p> <p>51 x 61 x 8 mm</p> <p>2 mounting holes</p> <p>-20 ... +60 °C</p> <p>Retroreflective photoelectric sensor (LED)</p>
		<p>153-00816</p> <p>Part number / Article number</p> <p>Description</p> <p>Dimensions</p> <p>Mounting</p> <p>Temperature range</p> <p>Suitable for</p>	<p>R50 BC / 904-51641</p> <p>Reflector, chemically resistant for critical cleaning processes</p> <p>51 x 69 x 8.1 mm</p> <p>6 mounting holes</p> <p>-20 ... +140 °C</p> <p>Retroreflective photoelectric sensor (LED)</p> <p>ECOLAB®</p>
		<p>153-00817</p> <p>Part number / Article number</p> <p>Description</p> <p>Dimensions</p> <p>Mounting</p> <p>Temperature range</p> <p>Suitable for</p>	<p>R100 BC / 904-51642</p> <p>Reflector, chemically resistant for critical cleaning processes</p> <p>100 x 100 x 9.2 mm</p> <p>2 mounting holes</p> <p>-20 ... +140 °C</p> <p>Retroreflective photoelectric sensor (LED)</p> <p>ECOLAB®</p>

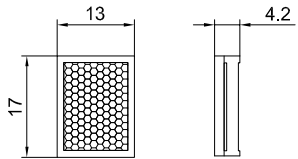
Reflectors for LED Retroreflective photoelectric sensor (Cont.)			
	<p style="text-align: right;">153-00557</p>	<p>Part number / Article number</p> <p>Description</p> <p>Dimensions</p> <p>Mounting</p> <p>Temperature range</p> <p>Suitable for</p>	<p>R10 / 904-51637 R10 / 2 (2 × R10) / 904-51636</p> <p>Reflector in housing 100 × 100 × 9 mm 2 mounting holes -40 ... +70 °C</p> <p>Retroreflective photoelectric sensor (LED) FR 85</p>
	<p style="text-align: right;">153-01014</p>	<p>Part number / Article number</p> <p>Description</p> <p>Dimensions</p> <p>Mounting</p> <p>Temperature range</p> <p>Suitable for</p>	<p>RD2-G / 904-51567</p> <p>Reflector in housing Ø 19 × 5.6 mm Grub screw M3, centred -20 ... +60 °C</p> <p>Retroreflective photoelectric sensor (LED)</p>
	<p style="text-align: right;">153-00066</p>	<p>Part number / Article number</p> <p>Description</p> <p>Dimensions</p> <p>Mounting</p> <p>Temperature range</p> <p>Suitable for</p>	<p>RD2 / 904-51534</p> <p>Reflector in housing Ø 21 × 5 mm Self-adhesive -20 ... +60 °C</p> <p>Retroreflective photoelectric sensor (LED)</p>
	<p style="text-align: right;">153-00067</p>	<p>Part number / Article number</p> <p>Description</p> <p>Dimensions</p> <p>Mounting</p> <p>Temperature range</p> <p>Suitable for</p>	<p>RD4 / 904-51535</p> <p>Reflector in housing Ø 42 × 9.5 mm Grub screw M5, centred -20 ... +60 °C</p> <p>Retroreflective photoelectric sensor (LED)</p>
	<p style="text-align: right;">153-00355</p>	<p>Part number / Article number</p> <p>Description</p> <p>Dimensions</p> <p>Mounting</p> <p>Temperature range</p> <p>Suitable for</p>	<p>RD46 / 904-51572</p> <p>Reflector in housing Ø 46 × 9.3 mm 2 mounting holes -20 ... +60 °C</p> <p>Retroreflective photoelectric sensor (LED)</p>
	<p style="text-align: right;">153-00070</p>	<p>Part number / Article number</p> <p>Description</p> <p>Dimensions</p> <p>Mounting</p> <p>Temperature range</p> <p>Suitable for</p>	<p>RD8 / 904-51531</p> <p>Reflector in housing Ø 84 × 9 mm 1 mounting hole, centred -20 ... +60 °C</p> <p>Retroreflective photoelectric sensor (LED)</p>

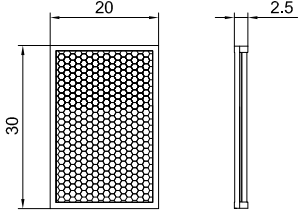
Accessories

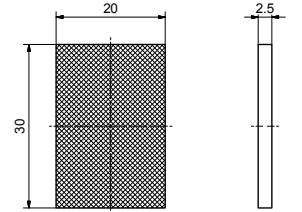

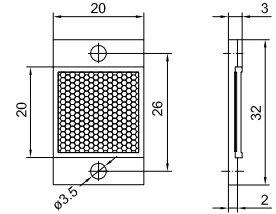

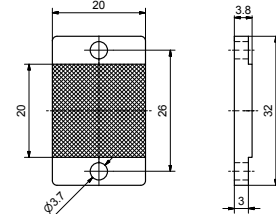



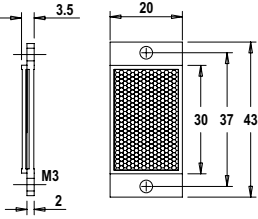

Reflectors

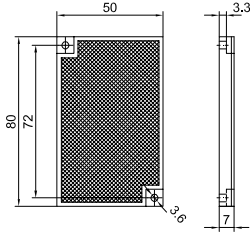
Reflectors for LED Retroreflective photoelectric sensor (Cont.)			
		<p>153-00775</p> <p>Part number / Article number</p> <p>Description</p> <p>Dimensions</p> <p>Mounting</p> <p>Temperature range</p> <p>Suitable for</p>	<p>R128 / 904-51550</p> <p>Reflector in housing, with protective glass for high robustness and high temperatures</p> <p>Ø 41 mm active area</p> <p>2 mounting holes</p> <p>-20 ... +300 °C</p> <p>Retroreflective photoelectric sensor (LED)</p>
		<p>153-00071</p> <p>Part number / Article number</p> <p>Description</p> <p>Dimensions</p> <p>Mounting</p> <p>Temperature range</p> <p>Suitable for</p>	<p>RF 10 / 904-51536</p> <p>Reflective foil</p> <p>100 x 100 mm</p> <p>Self-adhesive</p> <p>-34 ... +70 °C</p> <p>Retroreflective photoelectric sensor (LED)</p>
		<p>153-00556</p> <p>Part number / Article number</p> <p>Description</p> <p>Dimensions</p> <p>Mounting</p> <p>Temperature range</p> <p>Suitable for</p>	<p>RF 10C / 904-51633</p> <p>Reflective foil for FT 50 C colour sensor</p> <p>100 x 100 mm</p> <p>Self-adhesive</p> <p>-40 ... +70 °C</p> <p>FT 50 C</p>
		<p>153-01012</p> <p>Part number / Article number</p> <p>Description</p> <p>Dimensions</p> <p>Mounting</p> <p>Temperature range</p> <p>Suitable for</p>	<p>RF 600x115 / 904-51540</p> <p>Reflective foil for FMS 200-01 Analogue</p> <p>600 x 115 mm</p> <p>Self-adhesive</p> <p>-40 ... +70 °C</p> <p>Retroreflective photoelectric sensor (LED)</p>
		<p>153-01015</p> <p>Part number / Article number</p> <p>Description</p> <p>Dimensions</p> <p>Mounting</p> <p>Temperature range</p> <p>Suitable for</p>	<p>RF 775x ... mm / 904-51643</p> <p>Reflective foil, choice of length, weatherproof</p> <p>775 x x mm</p> <p>Self-adhesive</p> <p>-40 ... +70 °C</p> <p>Retroreflective photoelectric sensor (LED)</p>

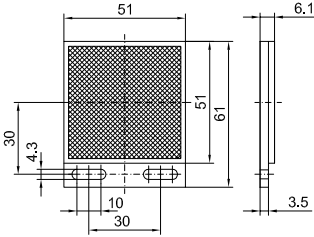

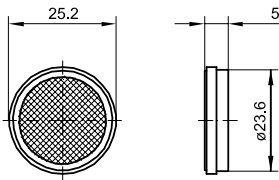

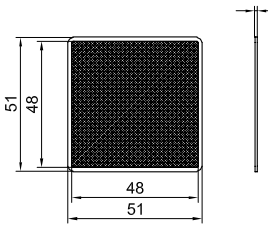

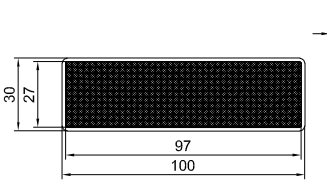
Reflectors for laser Retroreflective photoelectric sensor			
		<p>153-00280</p> <p>Part number / Article number</p> <p>Description</p> <p>Dimensions</p> <p>Mounting</p> <p>Temperature range</p> <p>Suitable for</p>	<p>R1L / 904-51559</p> <p>Reflector in housing</p> <p>10 × 62 × 3.5 mm</p> <p>2 mounting holes</p> <p>-20 ... +60 °C</p> <p>Retroreflective photoelectric sensor (laser)</p>
		<p>153-00771</p> <p>Part number / Article number</p> <p>Description</p> <p>Dimensions</p> <p>Mounting</p> <p>Temperature range</p> <p>Suitable for</p>	<p>R2-1LK / 904-51587</p> <p>Reflector in housing</p> <p>13 × 17 × 4.2 mm</p> <p>Self-adhesive</p> <p>-20 ... +60 °C</p> <p>Retroreflective photoelectric sensor (laser)</p>
		<p>153-00772</p> <p>Part number / Article number</p> <p>Description</p> <p>Dimensions</p> <p>Mounting</p> <p>Temperature range</p> <p>Suitable for</p>	<p>R3-2LK / 904-51588</p> <p>Reflector in housing</p> <p>20 × 30 × 2.5 mm</p> <p>Self-adhesive</p> <p>-20 ... +60 °C</p> <p>Retroreflective photoelectric sensor (laser)</p>
		<p>153-01047</p> <p>Part number / Article number</p> <p>Description</p> <p>Dimensions</p> <p>Mounting</p> <p>Temperature range</p> <p>Suitable for</p>	<p>R3-2LK1 / 904-51596</p> <p>Reflector in housing with very fine structure</p> <p>20 × 30 × 2.5 mm</p> <p>Self-adhesive</p> <p>-20 ... +60 °C</p> <p>Retroreflective photoelectric sensor (laser)</p>
		<p>153-00773</p> <p>Part number / Article number</p> <p>Description</p> <p>Dimensions</p> <p>Mounting</p> <p>Temperature range</p> <p>Suitable for</p>	<p>R2-2LB / 904-51586</p> <p>Reflector in housing</p> <p>20 × 32 × 3 mm</p> <p>2 mounting holes</p> <p>-20 ... +60 °C</p> <p>Retroreflective photoelectric sensor (laser)</p>
		<p>153-001046</p> <p>Part number / Article number</p> <p>Description</p> <p>Dimensions</p> <p>Mounting</p> <p>Temperature range</p> <p>Suitable for</p>	<p>R2-2LB1 / 904-51595</p> <p>Reflector in housing with very fine structure</p> <p>20 × 32 × 3.8 mm</p> <p>2 mounting holes</p> <p>-20 ... +60 °C</p> <p>Retroreflective photoelectric sensor (laser)</p>

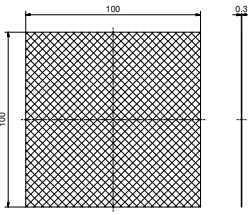
Accessories

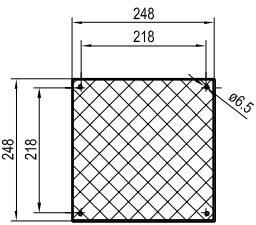
Reflectors

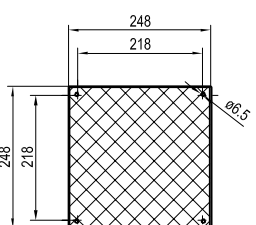

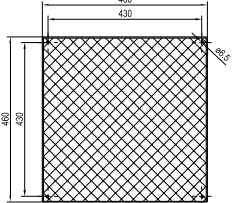

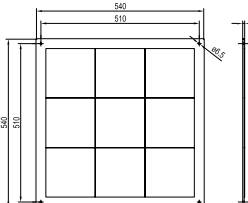

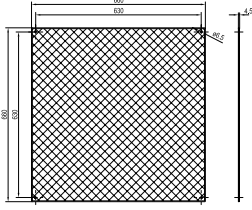

Reflectors for laser Retroreflective photoelectric sensor (Cont.)			
		<p>Part number / Article number</p> <p>Description</p> <p>Dimensions</p> <p>Mounting</p> <p>Temperature range</p> <p>Suitable for</p>	<p>R3-2LB / 904-51585</p> <p>Reflector in housing</p> <p>20 × 43 × 3.5 mm</p> <p>2 mounting holes</p> <p>-20 ... +60 °C</p> <p>Retroreflective photoelectric sensor (laser)</p>
		<p>Part number / Article number</p> <p>Description</p> <p>Dimensions</p> <p>Mounting</p> <p>Temperature range</p> <p>Suitable for</p>	<p>R5-8/L / 904-51576</p> <p>Reflector in housing</p> <p>50 × 80 × 7 mm</p> <p>2 mounting holes</p> <p>-20 ... +60 °C</p> <p>Retroreflective photoelectric sensor (laser)</p>
		<p>Part number / Article number</p> <p>Description</p> <p>Dimensions</p> <p>Mounting</p> <p>Temperature range</p> <p>Suitable for</p>	<p>R5L / 904-51543</p> <p>Reflector in housing</p> <p>51 × 61 × 6.1 mm</p> <p>2 mounting holes (slots)</p> <p>-20 ... +60 °C</p> <p>Retroreflective photoelectric sensor (laser)</p>
		<p>Part number / Article number</p> <p>Description</p> <p>Dimensions</p> <p>Mounting</p> <p>Temperature range</p> <p>Suitable for</p>	<p>RD-25 KL / 904-51589</p> <p>Reflector in housing</p> <p>Ø 25.2 × 5.5 mm</p> <p>Self-adhesive</p> <p>-20 ... +60 °C</p> <p>Retroreflective photoelectric sensor (laser)</p>
		<p>Part number / Article number</p> <p>Description</p> <p>Dimensions</p> <p>Mounting</p> <p>Temperature range</p> <p>Suitable for</p>	<p>RF-50 KL / 904-51590</p> <p>Reflective foil</p> <p>51 × 51 mm</p> <p>Self-adhesive</p> <p>-40 ... +70 °C</p> <p>Retroreflective photoelectric sensor (laser)</p>
		<p>Part number / Article number</p> <p>Description</p> <p>Dimensions</p> <p>Mounting</p> <p>Temperature range</p> <p>Suitable for</p>	<p>RF-30x100 KL / 904-51592</p> <p>Reflective foil</p> <p>100 × 30 mm</p> <p>Self-adhesive</p> <p>-40 ... +70 °C</p> <p>Retroreflective photoelectric sensor (laser)</p>

Reflectors for laser Retroreflective photoelectric sensor (Cont.)			
		Part number / Article number	RF-100 KL / 904-51644
		Description	Reflective foil 100 x 100 mm, to cut to size
		Dimensions Mounting Temperature range	100 x 100 mm Self-adhesive -40 ... +70 °C
		Suitable for	Retroreflective photoelectric sensor (laser)

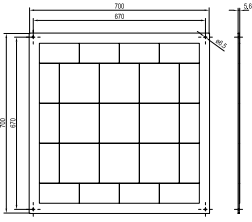
Reflectors for time-of-flight devices			
		Part number / Article number	RL 250 / 904-51562
		Description	Reflector for ranges up to 50 m / 70 m
		Dimensions Mounting Temperature range	248 x 248 x 4.5 mm 4 mounting holes -20 ... +60 °C
		Suitable for	FR 55, FR 90, FR 91
		Part number / Article number	RL 250/V / 904-51578
		Description	Reflector for ranges up to 30 m
		Dimensions Mounting Temperature range	248 x 248 x 4.5 mm 4 mounting holes -20 ... +60 °C
		Suitable for	FR 92
		Part number / Article number	RL 460 / 904-51565
		Description	Reflector for ranges up to 80 m
		Dimensions Mounting Temperature range	460 x 460 x 4.5 mm 4 mounting holes -20 ... +60 °C
		Suitable for	FR 90, FR 91, FR 92
		Part number / Article number	RL 540 / 904-51571
		Description	Reflector in housing for ranges up to 200 m
		Dimensions Mounting Temperature range	540 x 540 x 5.6 mm 4 mounting holes -20 ... +60 °C
		Suitable for	FR 90, FR 91, FR 92

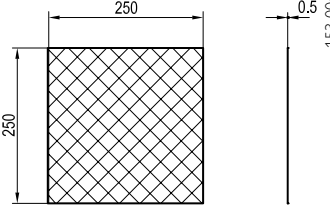
Accessories

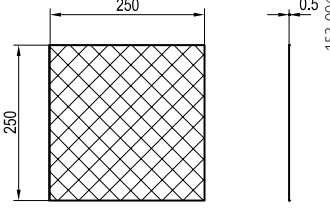
Reflectors

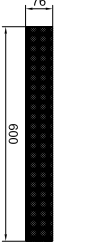
Reflectors für time-of-flight devices (Cont.)			
		<p>Part number / Article number</p> <p>Description</p> <p>Dimensions</p> <p>Mounting</p> <p>Temperature range</p> <p>Suitable for</p>	<p>RL 660 / 904-51564</p> <p>Reflector for ranges up to 80 m</p> <p>660 x 660 x 4.5 mm</p> <p>4 mounting holes</p> <p>-20 ... +60 °C</p> <p>FR 90, FR 91, FR 92</p>
		<p>Part number / Article number</p> <p>Description</p> <p>Dimensions</p> <p>Mounting</p> <p>Temperature range</p> <p>Suitable for</p>	<p>RL 700 / 904-51570</p> <p>Reflector in housing for ranges up to 250 m</p> <p>700 x 700 x 5,6 mm</p> <p>4 mounting holes</p> <p>-20 ... +60 °C</p> <p>FR 90, FR 91, FR 92</p>
		<p>Part number / Article number</p> <p>Description</p> <p>Dimensions</p> <p>Mounting</p> <p>Temperature range</p> <p>Suitable for</p>	<p>RF 250 / 599-91009</p> <p>Reflective foil for ranges up to 50 m / 70 m</p> <p>250 x 250 mm</p> <p>Self-adhesive</p> <p>-20 ... +60 °C</p> <p>FR 55, FR 90, FR 91</p>
		<p>Part number / Article number</p> <p>Description</p> <p>Dimensions</p> <p>Mounting</p> <p>Temperature range</p> <p>Suitable for</p>	<p>RF 250/V / 904-51579</p> <p>Reflective foil for ranges up to 30 m</p> <p>250 x 250 mm</p> <p>Self-adhesive</p> <p>-20 ... +60 °C</p> <p>FR 92</p>
		<p>Part number / Article number</p> <p>Description</p> <p>Dimensions</p> <p>Mounting</p> <p>Temperature range</p> <p>Suitable for</p>	<p>Reflective foil / 904-51548</p> <p>Reflective foil</p> <p>600 x 76 mm</p> <p>Self-adhesive</p> <p>-40 ... +70 °C</p> <p>FR 85</p>

Mounting of the reflectors as shown in the dimensional drawing or alignment according to labeling on reflector front

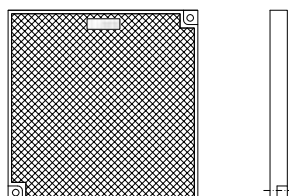



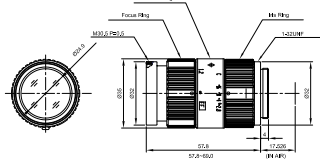

Lenses, C-mount			
		<p>Part number / Article number Description</p>	<p>LO C 8 / 526-51513 C-mount lens 8 mm focal length Aperture/focus: manual Filter thread: 30.5/0.5 Diameter: 33.5 mm Length: 28.2 Weight: 70 g</p>
		<p>Part number / Article number Description</p>	<p>LO C 12 / 526-51514 C-mount lens 12 mm focal length Aperture/focus: manual Filter thread: 30.5/0.5 Diameter: 33.5 mm Length: 28.2 mm Weight: 65 g</p>
		<p>Part number / Article number Description</p>	<p>LO C 16 / 526-51515 C-mount lens 16 mm focal length Aperture/focus: manual Filter thread: 30.5/0.5 Diameter: 33.5 mm Length: 28.2 mm Weight: 65 g</p>
		<p>Part number / Article number Description</p>	<p>LO C 25 / 526-51516 C-mount lens 25 mm focal length Aperture/focus: manual Filter thread: 30.5/0.5 Diameter: 33.5 mm Length: 36.0 mm Weight: 75 g</p>
		<p>Part number / Article number Description</p>	<p>LO C 35 / 526-51525 C-mount lens 35 mm focal length Aperture/focus: manual Filter thread: 30.5/0.5 Diameter: 33.5 mm Length: 38.2 mm Weight: 87 g</p>
		<p>Part number / Article number Description</p>	<p>LO C 50 / 526-51113 C-mount lens 50 mm focal length Aperture/focus: manual Filter thread: 30.5/0.5 Diameter: 33.5 mm Length: 38.1 mm Weight: 90 g</p>

Accessories

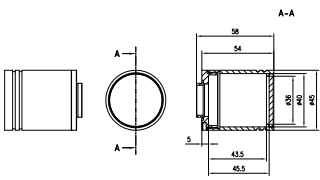
Lenses

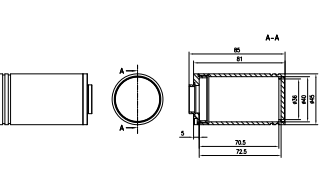
Lenses, C-mount (Cont.)			
		Part number / Article number	LO C 75 / 526-51116
		Description	C-mount lens 75 mm focal length Aperture/focus: manual Filter thread: 30.5/0.5 Diameter: 35.0 mm Length: 57.75 mm Weight: 113 g
		Suitable for	V10 / V20 C-Mount

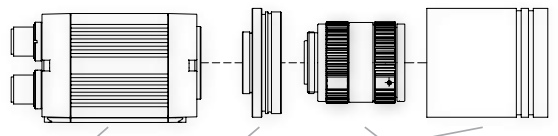
Protective casings			
		Part number / Article number	LPT 45 CML 5 / 527-51132
		Description	C-mount IP 65 protective casing Flange 5 mm Maximum lens dimensions: diameter: 38 mm length: 42 mm
		Suitable for	V10 / V20 C-Mount
		Part number / Article number	LPT 45 CML 5L / 527-51134
		Description	C-mount IP 65 protective casing Flange 5 mm Maximum lens dimensions: diameter: 38 mm length: 60 mm
		Suitable for	V10 / V20 C-Mount
		Part number / Article number	LPT 45 CML 5L / 527-51134
		Description	C-mount IP 65 protective casing Flange 5 mm Maximum lens dimensions: diameter: 38 mm length: 60 mm
		Suitable for	V10 / V20 C-Mount

Accessories, lenses			
	Part number	Article number	Description
	ET 0,5	038-12399	Intermediate ring 0.5 mm
	ET 1	038-12400	Intermediate ring 1 mm
	LR 5	543-11011	Intermediate ring 5 mm
	ET 10	038-12402	Intermediate ring 10 mm
	ETS	527-51129	Intermediate ring set
	Part number	Article number	Description
	LOF-BP-R635-30,5x0,5	533-01015	Red filter for C-mount lens, Bandpass 610 - 660 nm
	LOF-LP-IR850-30,5x0,5	533-01010	Infrared filter for C-mount lens, Transmission > 825 nm
LOF-PF-30,5 x 0,5	526-51531	Polarisation filter for C-mount lens	

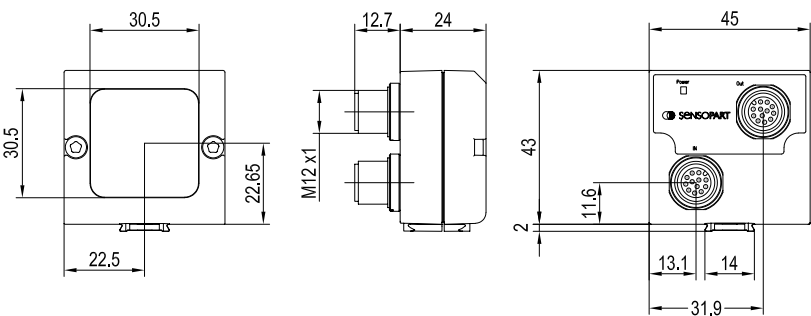
Surface light for V10, V20			
	Part number	Article number	Description
	LF45 W-24-2L12	525-51147	Surface light, V10 / V20, white, 12-pin
	LF45 R-24-2L12	525-51148	Surface light, V10 / V20, red, 12-pin
	LF45 IR-24-2L12	525-51149	Surface light, V10 / V20, infrared, 12-pin*
			153-00924

* External IR illumination can only be combined with IR Types or C-Mount sensors.
 LED area lighting for incidental illumination in IP67 housings. Can be cascaded to illuminate from several directions.
 No switching amplifier required.

Accessories

Illumination

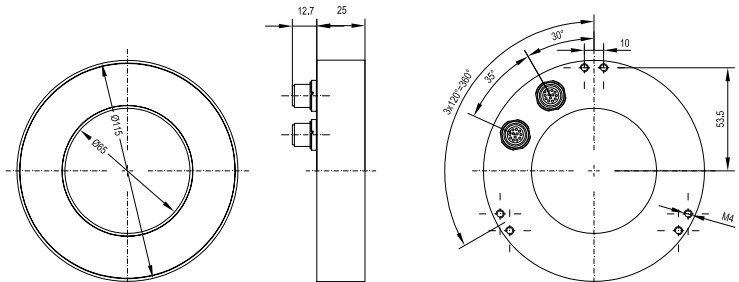
Ring light for V10, V20				
	Part number	Article number	Description	Angle bracket
	LFR 115 WD-24-2L12	525-51150	Ring light, V10 / V20, white, diffuse, 12-pin	543-11015
	LFR 115 RD-24-2L12	525-51151	Ring light, V10 / V20, red, diffuse, 12-pin	543-11015
	LFR 115 ID-24-2L12	525-51152	Ring light, V10 / V20, infrared, diffuse, 12-pin*	543-11015
	LFR 115 WK-24-2L12	525-51153	Ring light, V10 / V20, white, clear, 12-pin	543-11015
	LFR 115 RK-24-2L12	525-51154	Ring light, V10 / V20, red, clear, 12-pin	543-11015
	LFR 115 IK-24-2L12	525-51155	Ring light, V10 / V20, infrared, clear, 12-pin*	543-11015
				153-00926

* External IR illumination is only possible for IR types or C-Mount sensors.

LED ring lighting for the incidental illumination of objects in IP67-tight housings. No switching amplifier is required and cascading is possible.

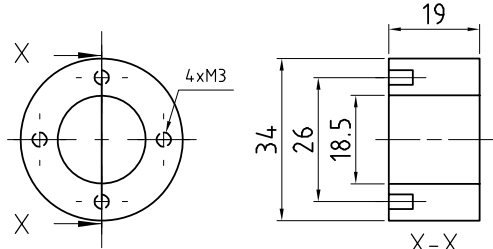
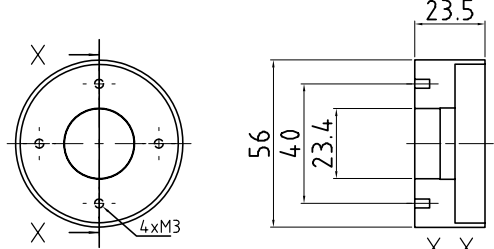
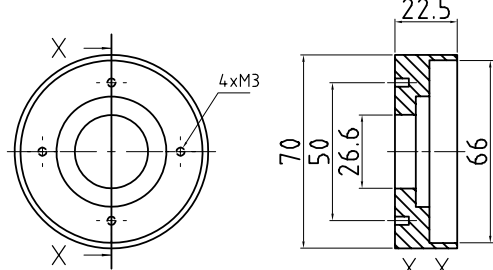
Ring light						
	Part number	Article number	Description	Angle bracket	Draw.	
	LR 32 W-24-KFL5	532-51000	Ring light, 32 mm, white	543-11016	1	
	LR 56 W-24-KFL5	532-51001	Ring light, 56 mm, white	543-11019	2	
	LR 70 W-24-KFL5	532-51002	Ring light, 70 mm, white	543-11017	3	
	LR 32 R-24-KFL5	532-51003	Ring light, 32 mm, red	543-11016	1	
	LR 56 R-24-KFL5	532-51004	Ring light, 56 mm, red	543-11019	2	
	LR 70 R-24-KFL5	532-51005	Ring light, 70 mm, red	543-11017	3	
1			153-00726	2		
3			153-00731			

LED ring lighting for the incidental illumination of objects.

Requires connection adapter for LED illumination LA45V-24-2L12.

Ring light, angled

	Part number	Article number	Description	Angle bracket	Draw.
	LR 50 WW-24-KFL5	532-51006	Ring light, angled, 50 mm, white	543-11017	1
	LR 74 WW-24-KFL5	532-51007	Ring light, angled, 74 mm, white	543-11018	2
	LR 90 WW-24-KFL5	532-51008	Ring light, angled, 90 mm, white	543-11018	3
	LR 132 WW-24-KFL5	532-51009	Ring light, angled, 132 mm, white	543-11015	4
	LR 50 RW-24-KFL5	532-51010	Ring light, angled, 50 mm, red	543-11017	1
	LR 74 RW-24-KFL5	532-51011	Ring light, angled, 74 mm, red	543-11018	2
	LR 90 RW-24-KFL5	532-51012	Ring light, angled, 90 mm, red	543-11018	3
	LR 132 RW-24-KFL5	532-51013	Ring light, angled, 132 mm, red	543-11015	4
	LR 75 WI-24-KFL5	532-51014	Ring light, indirect, 75 mm, white	543-11018	5
LR 130 WI-24-KFL5	532-51015	Ring light, indirect, 130 mm, white	543-11015	6	
LR 75 RI-24-KFL5	532-51016	Ring light, indirect, 75 mm, red	543-11018	5	
LR 130 RI-24-KFL5	532-51017	Ring light, indirect, 130 mm, red	543-11015	6	

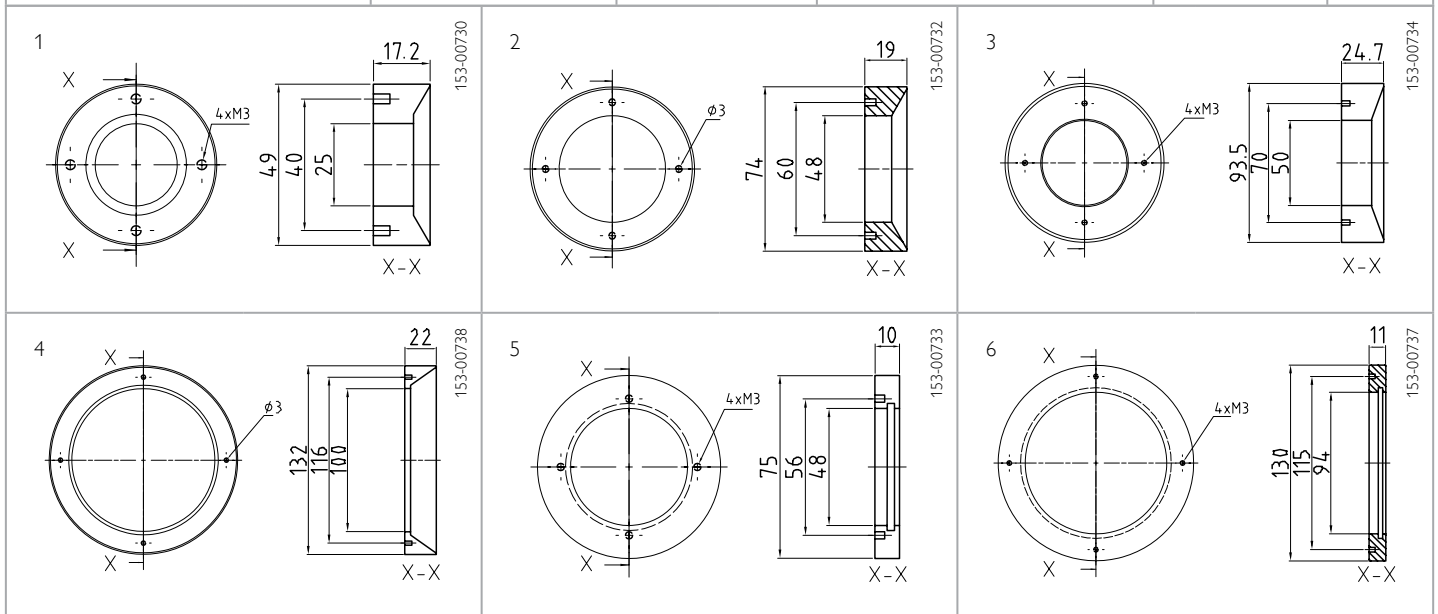



Funnel-shaped LED ring light for dark field illumination.
Requires connection adapter for LED illumination LA45V-24-2L12.

Accessories

Illumination

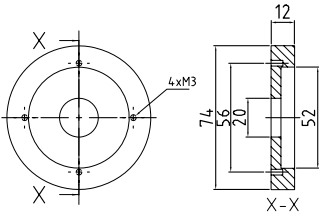
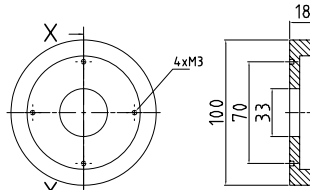
Ring light, indirect, diffuse					
	Part number	Article number	Description	Angle bracket	Draw.
	LR 70 WID-24-KFL5	532-51030	Ring light, indirect, diffuse, 70 mm, white	543-11019	1
	LR 100 WID-24-KFL5	532-51031	Ring light, indirect, diffuse, 100 mm, white	543-11018	2
	LR 70 RID-24-KFL5	532-51032	Ring light, indirect, diffuse, 70 mm, red	543-11019	1
	LR 100 RID-24-KFL5	532-51033	Ring light, indirect, diffuse, 100 mm, red	543-11018	2

1	153-00729	2	153-00735
			

Ring light, indirect, diffuse					
	Part number	Article number	Description	Angle bracket	Draw.
	LR 70 WD-24-KFL5	532-51034	Ring light, diffuse, 70 mm, white	543-11019	3
	LR 100 WD-24-KFL5	532-51035	Ring light, diffuse, 100 mm, white	543-11015	4
	LR 70 RD-24-KFL5	532-51036	Ring light, diffuse, 70 mm, red	543-11019	3
	LR 100 RD-24-KFL5	532-51037	Ring light, diffuse, 100 mm, red	543-11015	4

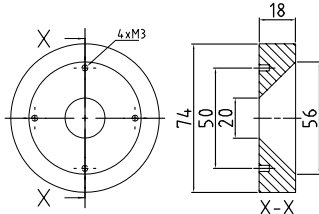
3	153-00728	4	153-00736
			

LED ring light with LEDs shining surfacely and directly on centre of circle.
Requires connection adapter for LED illumination LA45V-24-2L12.

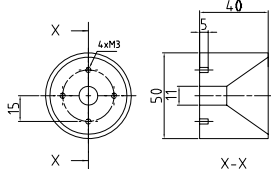
Ring light, dome, diffuse				
	Part number	Article number	Description	Angle bracket
	LD 50 WD-24-KFL5	532-51038	Ring light, dome, diffuse, 50 mm, white	543-11016
	LD 50 RD-24-KFL5	532-51039	Ring light, dome, diffuse, 50 mm, red	543-11016
		153-00704		

LED ring lighting with funnel-shaped diffuser sheet for strongly reflective objects.
Requires connection adapter for LED illumination LA45V-24-2L12.

Coaxial illumination				
	Part number	Article number	Description	Drawing
	LK 25 R-24-KFL5	532-51043	Coaxial lighting, 25 mm, red	1
	LK 46 R-24-KFL5	532-51044	Coaxial lighting, 46 mm, red	2

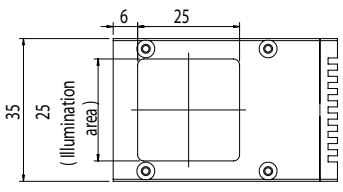
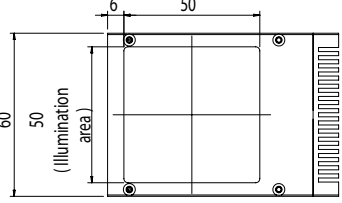
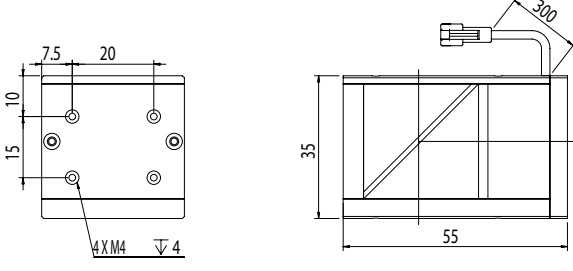
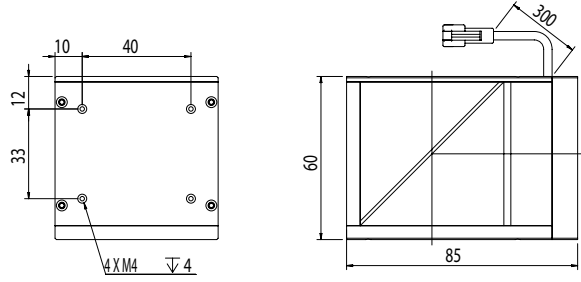
1		153-00830	2		153-00831
					

Coaxial mirrored LED lighting for homogeneous illumination of reflected objects.
Requires connection adapter for LED illumination LA45V-24-2L12.

Light strip, diffuse				
	Part number	Article number	Description	Type
	LB 44 WD-24-KFL5	532-51026	Light strip, diffuse, 44 mm, white	1
	LB 86 WD-24-KFL5	532-51027	Light strip, diffuse, 86 mm, white	2
	LB 180 WD-24-KFL5	532-51049	Light strip, diffuse, 180 mm, white	3
	LB 44 RD-24-KFL5	532-51028	Light strip, diffuse, 44 mm, red	1
	LB 86 RD-24-KFL5	532-51029	Light strip, diffuse, 86 mm, red	2
	LB 180 RD-24-KFL5	532-51052	Light strip, diffuse, 180 mm, red	3

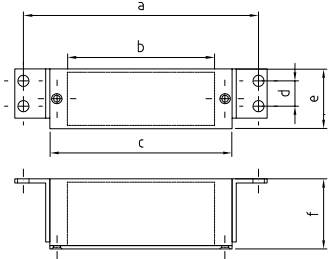
	153-00756																															
			<table border="1"> <thead> <tr> <th></th> <th>Type 1</th> <th>Type 2</th> <th>Type 3</th> </tr> </thead> <tbody> <tr> <td>a</td> <td>67 mm</td> <td>109 mm</td> <td>206.5 mm</td> </tr> <tr> <td>b</td> <td>42 mm</td> <td>84 mm</td> <td>181 mm</td> </tr> <tr> <td>c</td> <td>52 mm</td> <td>95 mm</td> <td>191 mm</td> </tr> <tr> <td>d</td> <td>7 mm</td> <td>7 mm</td> <td>7.2 mm</td> </tr> <tr> <td>e</td> <td>17 mm</td> <td>17 mm</td> <td>17.5 mm</td> </tr> <tr> <td>f</td> <td>20 mm</td> <td>20 mm</td> <td>20 mm</td> </tr> </tbody> </table>		Type 1	Type 2	Type 3	a	67 mm	109 mm	206.5 mm	b	42 mm	84 mm	181 mm	c	52 mm	95 mm	191 mm	d	7 mm	7 mm	7.2 mm	e	17 mm	17 mm	17.5 mm	f	20 mm	20 mm	20 mm	
	Type 1	Type 2	Type 3																													
a	67 mm	109 mm	206.5 mm																													
b	42 mm	84 mm	181 mm																													
c	52 mm	95 mm	191 mm																													
d	7 mm	7 mm	7.2 mm																													
e	17 mm	17 mm	17.5 mm																													
f	20 mm	20 mm	20 mm																													

Bar-shaped light strip with diffuser sheet for indirect illumination.
Requires connection adapter for LED illumination LA45V-24-2L12.

Accessories

Illumination

Surface light				
	Part number	Article number	Description	Drawing
	LF 36 WD-24-KFL5	532-51018	Surface light, diffuse, 36 mm, white	1
	LF 51 WD-24-KFL5	532-51019	Surface light, diffuse, 51 mm, white	2
	LF 100 WD-24-KFL5	532-51020	Surface light, diffuse, 100 mm, white	3
	LF 200 WD-24-KFL5	532-51024	Surface light, diffuse, 200 mm, white	4
	LF 36 RD-24-KFL5	532-51021	Surface light, diffuse, 36 mm, red	1
	LF 51 RD-24-KFL5	532-51022	Surface light, diffuse, 51 mm, red	2
	LF 100 RD-24-KFL5	532-51023	Surface light, diffuse, 100 mm, red	3
	LF 200 RD-24-KFL5	532-51025	Surface light, diffuse, 200 mm, red	4

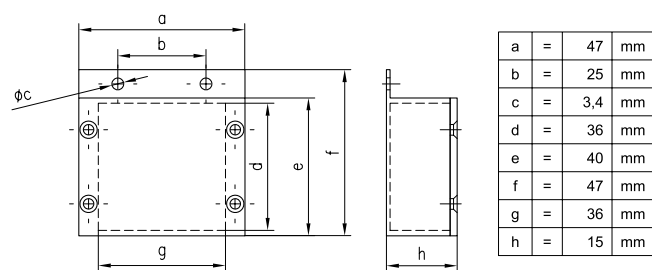
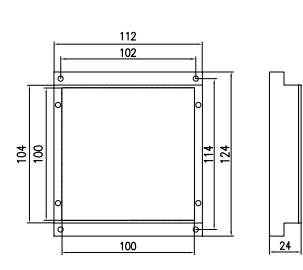
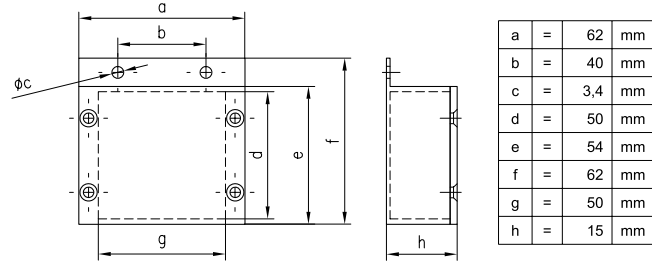
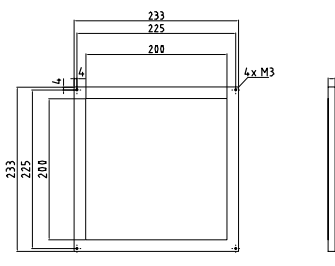
<p>1</p>  <table border="1"> <tr><td>a</td><td>=</td><td>47</td><td>mm</td></tr> <tr><td>b</td><td>=</td><td>25</td><td>mm</td></tr> <tr><td>c</td><td>=</td><td>3,4</td><td>mm</td></tr> <tr><td>d</td><td>=</td><td>36</td><td>mm</td></tr> <tr><td>e</td><td>=</td><td>40</td><td>mm</td></tr> <tr><td>f</td><td>=</td><td>47</td><td>mm</td></tr> <tr><td>g</td><td>=</td><td>36</td><td>mm</td></tr> <tr><td>h</td><td>=</td><td>15</td><td>mm</td></tr> </table>	a	=	47	mm	b	=	25	mm	c	=	3,4	mm	d	=	36	mm	e	=	40	mm	f	=	47	mm	g	=	36	mm	h	=	15	mm	153-00758	<p>3</p> 	153-00762
a	=	47	mm																																
b	=	25	mm																																
c	=	3,4	mm																																
d	=	36	mm																																
e	=	40	mm																																
f	=	47	mm																																
g	=	36	mm																																
h	=	15	mm																																
<p>2</p>  <table border="1"> <tr><td>a</td><td>=</td><td>62</td><td>mm</td></tr> <tr><td>b</td><td>=</td><td>40</td><td>mm</td></tr> <tr><td>c</td><td>=</td><td>3,4</td><td>mm</td></tr> <tr><td>d</td><td>=</td><td>50</td><td>mm</td></tr> <tr><td>e</td><td>=</td><td>54</td><td>mm</td></tr> <tr><td>f</td><td>=</td><td>62</td><td>mm</td></tr> <tr><td>g</td><td>=</td><td>50</td><td>mm</td></tr> <tr><td>h</td><td>=</td><td>15</td><td>mm</td></tr> </table>	a	=	62	mm	b	=	40	mm	c	=	3,4	mm	d	=	50	mm	e	=	54	mm	f	=	62	mm	g	=	50	mm	h	=	15	mm	153-00758	<p>4</p> 	153-00757
a	=	62	mm																																
b	=	40	mm																																
c	=	3,4	mm																																
d	=	50	mm																																
e	=	54	mm																																
f	=	62	mm																																
g	=	50	mm																																
h	=	15	mm																																

Surface LED background illumination with very bright, regular surface illumination.
 Requires connection adapter for LED illumination LA45V-24-2L12.

Surface light				
	Part number	Article number	Description	Drawing
	LF 100 A RD-24-KFL5	532-51040	Surface light, 100 mm, red, diffuse	1
	LF 60 A RD-24-KFL5	532-51041	Surface light, 60 mm, red, diffuse	2
	LF 100 A WD-24-KFL5-65	532-51042	Surface light, 100 mm, white, diffuse, IP 65	3

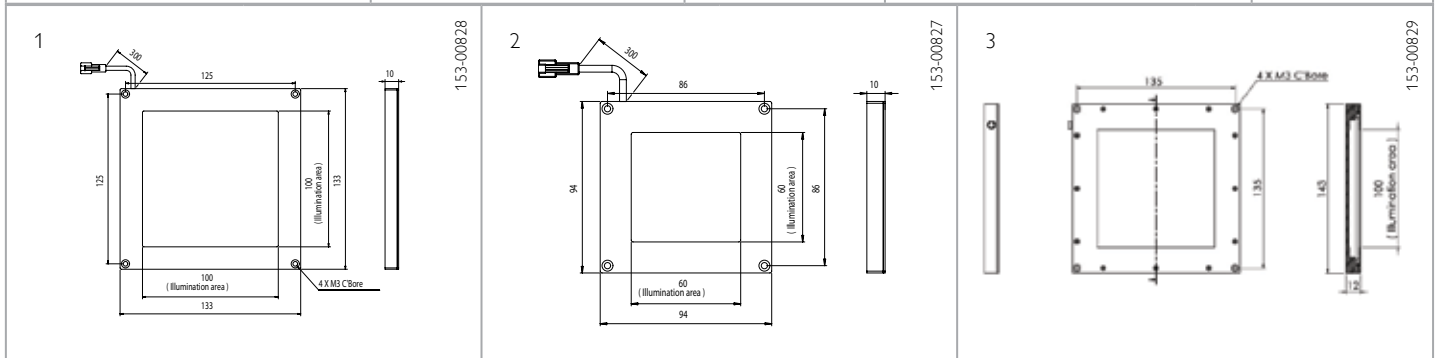

Surface LED background lighting for diffuse illumination.
Requires connection adapter for LED illumination LA45V-24-2L12.

LZS neon tubes							
	Part number	Article number	Light source	Dimensions (mm)	Power supply	Enclosure rating	Draw.
	LZS 08230-50	525-51122	D16x200/D60 X=350	Ø60 x 350	230V AC	IP 50	1
	LZS 13230-50	525-51123	D16x360/D60 X=580	Ø60 x 580	230V AC	IP 50	1
	LZS 18230-67	525-51126	D26x420/D70 X=940	Ø70 x 940	230V AC	IP 67	1
	LZS 18024-54	525-51124	D26x420/45x108 X=635	635 x 45 x 108	24V DC	IP 54	2
	LZS 18230-54	525-51125	D26x420/45x108 X=635	635 x 45 x 108	230V AC	IP 54	2
	LZS 36024-54	525-51127	D26x1000/45x108 X=1245	1245 x 45 x 108	24V DC	IP 54	2

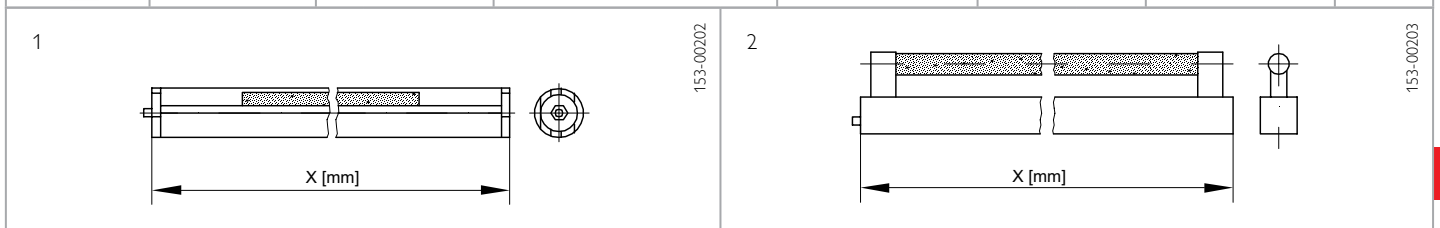

High-frequency fluorescent tubes for extensive illumination.

Accessories

Illumination

Light strips, High Power, LBxxx

	Part number	Article number	Description	Type
	LB 250 WK 24 A15 3L5	532-51056	Light strip, 250 mm, white, clear glass, 24V DC, 15°, 3 x M12, 5-pin	1
	LB 375 WK 24 A15 3L5	532-51057	Light strip, 375 mm, white, clear glass, 24V DC, 15°, 3 x M12, 5-pin	2
	LB 625 WK 24 A15 3L5	532-51058	Light strip, 625 mm, white, clear glass, 24V DC, 15°, 3 x M12, 5-pin	3
	LB 1000 WK 24 A15 3L5	532-51059	Light strip, 1000 mm, white, clear glass, 24V DC, 15°, 3 x M12, 5-pin	4
	LB 250 WK 24 A35 3L5	532-51060	Light strip, 250 mm, white, clear glass, 24V DC, 35°, 3 x M12, 5-pin	1
	LB 375 WK 24 A35 3L5	532-51061	Light strip, 375 mm, white, clear glass, 24V DC, 35°, 3 x M12, 5-pin	2
	LB 625 WK 24 A35 3L5	532-51062	Light strip, 625 mm, white, clear glass, 24V DC, 35°, 3 x M12, 5-pin	3
	LB 1000 WK 24 A35 3L5	532-51063	Light strip, 1000 mm, white, clear glass, 24V DC, 35°, 3 x M12, 5-pin	4
	LB 250 RK 24 A15 3L5	532-51064	Light strip, 250 mm, red, clear glass, 24V DC, 15°, 3 x M12, 5-pin	1
	LB 375 RK 24 A15 3L5	532-51065	Light strip, 375 mm, red, clear glass, 24V DC, 15°, 3 x M12, 5-pin	2
	LB 625 RK 24 A15 3L5	532-51066	Light strip, 625 mm, red, clear glass, 24V DC, 15°, 3 x M12, 5-pin	3
	LB 1000 RK 24 A15 3L5	532-51067	Light strip, 1000 mm, red, clear glass, 24V DC, 15°, 3 x M12, 5-pin	4
	LB 250 RK 24 A35 3L5	532-51068	Light strip, 250 mm, red, clear glass, 24V DC, 35°, 3 x M12, 5-pin	1
	LB 375 RK 24 A35 3L5	532-51069	Light strip, 375 mm, red, clear glass, 24V DC, 35°, 3 x M12, 5-pin	2
	LB 625 RK 24 A35 3L5	532-51070	Light strip, 625 mm, red, clear glass, 24V DC, 35°, 3 x M12, 5-pin	3
	LB 1000 RK 24 A35 3L5	532-51071	Light strip, 1000 mm, red, clear glass, 24V DC, 35°, 3 x M12, 5-pin	4
	LB 250 IRK 24 A15 3L5	532-51055	Light strip, 250 mm, infrared, clear glass, 24V DC, 15°, 3 x M12, 5-pin	1
	LB 375 IRK 24 A15 3L5	532-51072	Light strip, 375 mm, infrared, clear glass, 24V DC, 15°, 3 x M12, 5-pin	2
	LB 625 IRK 24 A15 3L5	532-51073	Light strip, 625 mm, infrared, clear glass, 24V DC, 15°, 3 x M12, 5-pin	3
	LB 1000 IRK 24 A15 3L5	532-51074	Light strip, 1000 mm, infrared, clear glass, 24V DC, 15°, 3 x M12, 5-pin	4
	LB 250 IRK 24 A35 3L5	532-51075	Light strip, 250 mm, infrared, clear glass, 24V DC, 35°, 3 x M12, 5-pin	1
	LB 375 IRK 24 A35 3L5	532-51076	Light strip, 375 mm, infrared, clear glass, 24V DC, 35°, 3 x M12, 5-pin	2
	LB 625 IRK 24 A35 3L5	532-51077	Light strip, 625 mm, infrared, clear glass, 24V DC, 35°, 3 x M12, 5-pin	3
	LB 1000 IRK 24 A35 3L5	532-51078	Light strip, 1000 mm, infrared, clear glass, 24V DC, 35°, 3 x M12, 5-pin	4



Accessories

Connection cables

From Page A-34

Brackets

From Page A-4

Light strips, High Power, LBxxx

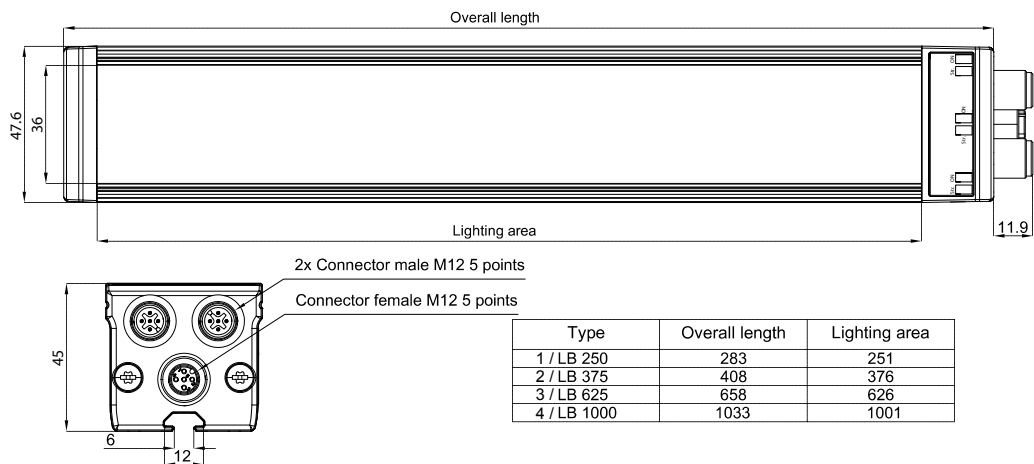

Mounting

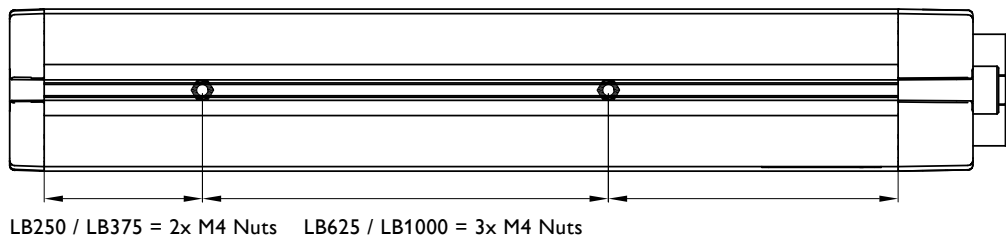

155-01926

Wiring

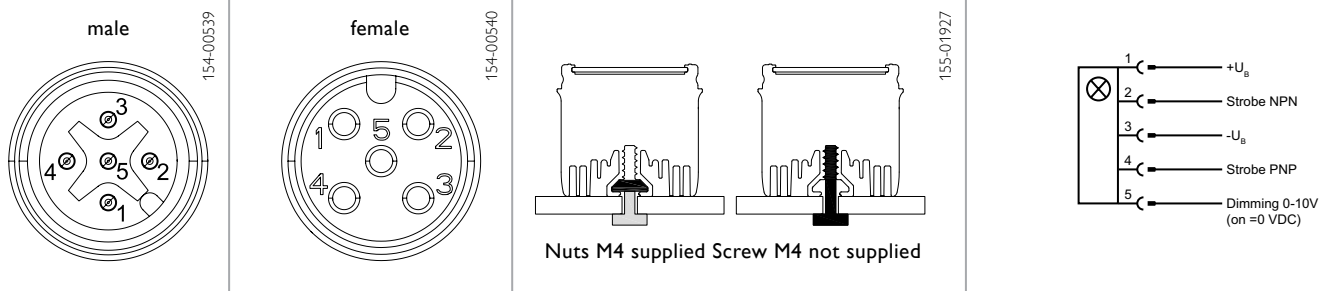

154-00532

Connection illumination - sensor

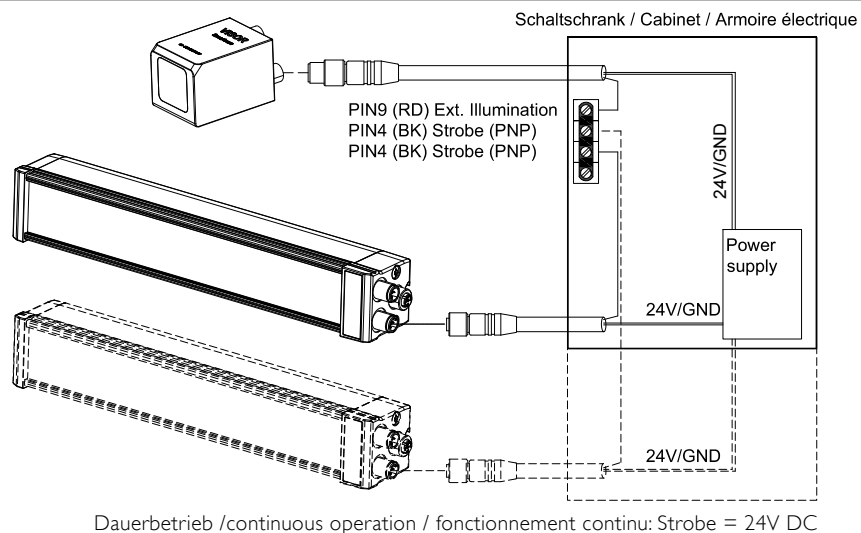

155-01906

A





Dauerbetrieb / continuous operation / fonctionnement continu: Strobe = 24V DC

Accessories

Cables



- Cables
- Converters
- Power supply units and switching devices

Straight connectors	90° connectors	90° connectors with LED	Shielded connectors
			

Part number	Article number	Description
M5, 4-pin		
CN4 FG-2m-PUR	902-51793	2 m, straight, PUR
CN4 FG-5m-PUR	902-51791	5 m, straight, PUR
CN4 FW-2m-PUR	902-51794	2 m, 90°, PUR
CN4 FW-5m-PUR	902-51792	5 m, 90°, PUR
M8, 3-pin		
K3-2m-G-PUR	902-50679	2 m, straight, PUR
K3-5m-G-PUR	902-51614	5 m, straight, PUR, suitable for drag chains
K3-10m-G-PUR	902-50694	10 m, straight, PUR, suitable for drag chains
K3-2m-W-PUR	902-50681	2 m, 90°, PUR, suitable for drag chains
K3-5m-W-PUR	902-51615	5 m, 90°, PUR, suitable for drag chains
K3-2m-W-PL-PUR	902-50683	2 m, 90°, PUR, with indicator LED
K3-5m-W-PL-PUR	902-51616	5 m, 90°, PUR, with indicator LED, suitable for drag chains
K3-10m-W-PL-PUR	902-50693	10 m, 90°, PUR, with indicator LED, suitable for drag chains
M8, 4-pin		
K4-2m-G-PUR	902-50801	2 m, straight, PUR, suitable for drag chains
K4-5m-G-PUR	902-51617	5 m, straight, PUR, suitable for drag chains
K4-10m-G-PUR	902-51610	10 m, straight, PUR, suitable for drag chains
K4-2m-W-PUR	902-50803	2 m, 90°, PUR, suitable for drag chains
K4-5m-W-PUR	902-51618	5 m, 90°, PUR, suitable for drag chains
K4-10m-W-PUR	902-51629	10 m, 90°, PUR, suitable for drag chains
K4-2m-W-PL-PUR	902-51642	2 m, 90°, PUR, with indicator LED
K4-5m-W-PL-PUR	902-51643	5 m, 90°, PUR, with indicator LED
CM4 FG-E-5m-PVC	902-50221	5 m, straight, PVC, with hex nut SW 9 stainless steel (IP 69K), suitable for drag chains
CM4 FW-E-5m-PVC	902-50222	5 m, 90°, PVC, with hex nut SW 9 stainless steel (IP 69K), suitable for drag chains

Part number	Article number	Description
M12, 3-pin		
L3-2m-G-PUR	902-50687	2 m, straight, PUR, suitable for drag chains
L3-5m-G-PUR	902-51619	5 m, straight, PUR, suitable for drag chains
L3-2m-W-PUR	902-50689	2 m, 90°, PUR, suitable for drag chains
L3-5m-W-PUR	902-51620	5 m, 90°, PUR, suitable for drag chains
L3-2m-W-PL-PUR	902-50690	2 m, 90°, PUR, with indicator LED, suitable for drag chains
L3-5m-W-PL-PUR	902-51621	5 m, 90°, PUR, with indicator LED, suitable for drag chains
M12, 4-pin		
L4-300mm-G-PUR	902-50811	300 mm, straight, PUR
L4-2m-G-PUR	902-50805	2 m, straight, PUR, suitable for drag chains
L4-5m-G-PUR	902-51612	5 m, straight, PUR, suitable for drag chains
L4-10m-G-PUR	902-51628	10 m, straight, PUR, suitable for drag chains
L4-2m-W-PUR	902-50807	2 m, 90°, PUR, suitable for drag chains
L4-5m-W-PUR	902-51602	5 m, 90°, PUR, suitable for drag chains
L4-2m-W-PL-PUR	902-50808	2 m, 90°, PUR, with indicator LED, suitable for drag chains
L4-5m-W-PL-PUR	902-51603	5 m, 90°, PUR, with indicator LED, suitable for drag chains
L4-10m-W-PL-PUR	902-51604	10 m, 90°, PUR, with indicator LED, suitable for drag chains
L4-15m-W-PL-PUR	902-51607	15 m, 90°, PUR, with indicator LED,
L4S-2m-G-PVC	902-51632	2 m, straight, PVC, shielded
L4S-5m-G-PVC	902-51634	5 m, straight, PVC, shielded
L4S-10m-G-PVC	902-51651	10 m, straight, PVC, shielded
L4S-2m-W-PVC	902-51633	2 m, 90°, PVC, shielded
L4S-5m-W-PVC	902-51635	5 m, 90°, PVC, shielded
CL4 FG-E-5m-PVC	902-50219	5 m, straight, PVC, with hex nut SW 14 stainless steel (IP 69K), suitable for drag chains
CL4 FW-E-5m-PVC	902-50220	5 m, 90°, PVC, with hex nut SW 14 stainless steel (IP 69K), suitable for drag chains
L4 KDG	022-50812	Coupling socket, straight
L4 KDW	022-50813	Coupling socket, 90°
LS4-60-G-K	022-10773	Plug connection
L4F/L4M-0,48 PUR	902-51670	Extension cable / connection cable FR 85, M12 (angled, a-coded) to M12 (straight, a-coded), 0.48 m, suitable for drag chains
L4F/L4M-b-coded-0,48 PUR	902-51739	Connection cable FR 85, M12 (angled, a-coded) to M12 (straight, b-coded), 0.48 m, suitable for drag chains
L4F/L4M-b-coded-0,53 PUR	902-51825	Connection cable FR 85, M12 (angled, a-coded) to M12 (straight, b-coded), 0.53 m, suitable for drag chains
L4F/L4M-b-coded-0,48-X02 PUR	902-51823	Connection cable FR 85, M12 (angled, a-coded) to M12 (straight, b-coded), PINs 2 & 4 interchanged, suitable for drag chains
M12, 5-pin		
L5-2m-G-PUR	902-51652	2 m, straight, PUR, suitable for drag chains
L5-5m-G-PUR	902-51624	5 m, straight, PUR, suitable for drag chains
L5-10m-G-PUR	902-51609	10 m, straight, PUR, suitable for drag chains
L5-2m-W-PUR	902-51613	2 m, 90°, PUR, suitable for drag chains
L5-5m-W-PUR	902-51641	5 m, 90°, PUR, suitable for drag chains
M12, 8-pin		
L8FS-2m-G-PUR	902-51671	2 m, straight, PUR, shielded, suitable for drag chains
L8FS-5m-G-PUR	902-51646	5 m, straight, PUR, shielded, suitable for drag chains
L8FS-10m-G-PUR	902-51689	10 m, straight, PUR, shielded, suitable for drag chains
L8FS-2m-W-PUR	902-51687	2 m, 90°, PUR, shielded, suitable for drag chains
L8FS-5m-W-PUR	902-51688	5 m, 90°, PUR, shielded, suitable for drag chains
L8FS-10m-W-PUR	902-51690	10 m, 90°, PUR, shielded, suitable for drag chains
C L8FG-S-2m-PUR	902-51830	2 m straight, PUR, shielded, colour assignment in acc. to DIN 60947-5-2, suitable for drag chains
C L8FG-S-5m-PUR	902-51831	5 m straight, PUR, shielded, colour assignment in acc. to DIN 60947-5-2, suitable for drag chains
C L8FG-S-10m-PUR	902-51832	10 m straight, PUR, shielded, colour assignment in acc. to DIN 60947-5-2, suitable for drag chains

Accessories

Cables

Part number	Article number	Description
M16, 12-pin		
Q12-3m-G-PVC	902-51656	3 m, straight, PVC
Q12-5m-G-PVC	902-51657	5 m, straight, PVC
Q12-10m-G-PVC	902-51658	10 m, straight, PVC
Q12-20m-G-PVC	902-51663	20 m, straight, PVC
Q12-30m-G-PVC	902-51664	30 m, straight, PVC
Q12-3m-W-PVC	902-51659	3 m, 90°, PVC
Q12-10m-W-PVC	902-51661	10 m, 90°, PVC
Cables for SmartPlug		
IR-RS232	901-05096	Programmer adapter (MFU)
CUSB-IR-2m	901-05098	Converter; USB to infrared (SmartPlug)
L3M/K3F-0,6 PUR	902-51653	Connection adapter M12 3-pin straight (plug), M8 3-pin straight (socket), suitable for drag chains
L4M/K4F-0,6 PVC	902-51645	Connection adapter M12 4-pin straight (plug), M8 4-pin straight (socket), suitable for drag chains
L4M/K4FW-0,6 PVC	902-51650	Connection adapter M12 4-pin straight (plug), M8 4-pin 90° (socket)
L5F/Q8F-0,5 PUR	606-51686	Connection adapter M12 5-pin straight (socket), M16 8-pin straight (plug), (also for FR 85)
Power supply and I/O cables for V10, V20		
C L12FG-S-2m-PUR	902-51801	Power supply and I/O cable, 2 m, M12, straight, 12-pin, shielded, suitable for drag chains
C L12FG-S-5m-PUR	902-51796	Power supply and I/O cable, 5 m, M12, straight, 12-pin, shielded, suitable for drag chains
C L12FG-S-10m-PUR	902-51797	Power supply and I/O cable, 10 m, M12, straight, 12-pin, shielded, suitable for drag chains
C L12FW-S-2m-PUR	902-51798	Power supply and I/O cable, 2 m, M12, 90°, 12-pin, shielded, suitable for drag chains
C L12FW-S-5m-PUR	902-51799	Power supply and I/O cable, 5 m, M12, 90°, 12-pin, shielded, suitable for drag chains
C L12FW-S-10m-PUR	902-51800	Power supply and I/O cable, 10 m, M12, 90°, 12-pin, shielded, suitable for drag chains
C L12FG-S-20m-PUR	902-51805	Power - I/O, cable, 20 m, M12, straight, 12-pin, shielded, suitable for drag chains
C L12FW-S-20m-PUR	902-51821	Power - I/O, cable, 20 m, M12, 90°, 12-pin, shielded, suitable for drag chains
Ethernet cables for V10/V20		
CI L4MG/RJ45G-GS-3m-PUR	902-51754	Ethernet cable, 3 m, M12, straight, 4-pin/RJ45, shielded, suitable for drag chains
CI L4MG/RJ45G-GS-5m-PUR	902-51782	Ethernet cable, 5 m, M12, straight, 4-pin/RJ45, shielded, suitable for drag chains
CI L4MG/RJ45G-GS-10m-PUR	902-51784	Ethernet cable, 10 m, M12, straight, 4-pin/RJ45, shielded, suitable for drag chains
CI L4MW/RJ45G-GS-3m-PUR	902-51786	Ethernet cable, 3 m, M12, 90°, 4-pin/RJ45, shielded, suitable for drag chains
CI L4MW/RJ45G-GS-5m-PUR	902-51788	Ethernet cable, 5 m, M12, 90°, 4-pin/RJ45, shielded, suitable for drag chains
CI L4MW/RJ45G-GS-10m-PUR	902-51790	Ethernet cable, 10 m, M12, 90°, 4-pin/RJ45, shielded, suitable for drag chains
CI L4MG/RJ45G-GS-20m-PUR	902-51820	Ethernet, cable, 20m, M12, straight connector; 4-pin/RJ45 shielded
CI L4MW/RJ45G-GS-20m-PUR	902-51822	Ethernet, cable, 20m, M12, angled connector; 4-pin/RJ45 shielded
Data cables for V10/V20		
CI L5FG-S-2m-PUR	902-51813	Data cable, 2 m, straight, shielded, suitable for drag chains
CI L5FG-S-5m-PUR	902-51814	Data cable, 5 m, straight, shielded, suitable for drag chains
CI L5FG-S-10m-PUR	902-51815	Data cable, 10 m, straight, shielded, suitable for drag chains
CI L5FW-S-2m-PUR	902-51816	Data cable, 2 m, 90°, shielded, suitable for drag chains
CI L5FW-S-5m-PUR	902-51817	Data cable, 5 m, 90°, shielded, suitable for drag chains
CI L5FW-S-10m-PUR	902-51818	Data cable, 10 m, 90°, shielded, suitable for drag chains
Illumination cables for V10/V20		
CB L12FS/L12FS-0,5m-GG-PUR	902-51806	Illumination cable 2 x M12/12-pin, 0,5 m, straight, shielded, suitable for drag chains
CB L12FS/L12FS-2m-GG-PUR	902-51807	Illumination cable 2 x M12/12-pin, 2 m, straight, shielded, suitable for drag chains
CB L12FS/L12FS-0,5m-VVW-PUR	902-51808	Illumination cable 2 x M12/12-pin, 0,5 m, 90°, shielded, suitable for drag chains
CB L12FS/L12FS-2m-VVW-PUR	902-51809	Illumination cable 2 x M12/12-pin, 2 m, 90°, shielded, suitable for drag chains
CB L4MG-10m-PUR	902-51756	Illumination cable 1 x M12/4-pin, 10 m, suitable for drag chains for direct connection of devices 532-51000 to 532-51044

Part number	Article number	Description
Connection adapter, illumination LA45V-24-2L12	525-01001	V10 /V20 connection adapter for LED illumination with 5-pin M12 plug

Connection adapter for illumination on V10, V20



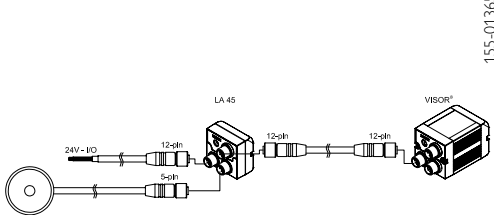

155-01365

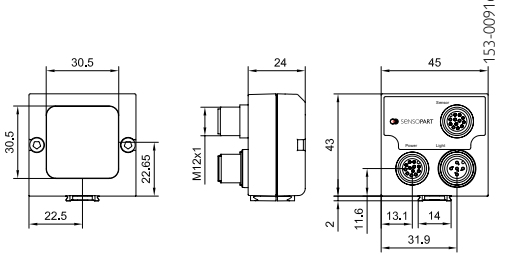

153-00916

Accessories

Converters

Part number	Article number	Description
Converters and adapter cables		
K2-ADE-TB	533-11017	Converter RS232 ↔ RS485/422, in combination with CUSB-RS232-2m (901-05097) for PC connection of F 90/91 sensors, parameterisation via „ProgSensor“ software
CUSB-RS232-2m	901-05097	Interface converter incl. CD-ROM, cable 2 m, USB ↔ RS232, in combination with K2-ADE-TB (533-11017) for PC connection of F 90/91 sensors, parameterisation via „ProgSensor“ software
CUSB-RS485-SET	533-01005	Set: interface converter incl. CD-ROM, cable 0.7 m, USB ↔ RS485 and D-SUB socket, 9-pin, socket, for PC connection of F 50/80 sensors, parameterisation via „ProgSensor“ software
CUSB-RS485-0,7m	533-01004	Interface converter incl. CD-ROM, cable 0.7 m, USB ↔ RS485
AS S7/B1 D9F-D9F	902-51735	Anybus Communicator 4, PROFIBUS Interface
CB L12F5/L8MS-0,15m-GG-PUR	902-51810	Power and I/O adapter cable, M12, 8-pin ↔ M12, 12-pin
CI L8MGK/L4MGK-S-0,2m-PVC	902-51773	Ethernet adapter cable, M12, 8-pin ↔ M12, 4-pin
CI L4GFK/L8FGK-S-0,2m-PVC	902-51751	Ethernet adapter cable, M12, 4-pin ↔ M12, 8-pin

Interface Converter (USB / RS232 / RS485 / RS422)

Fx 9x ILA-S2-Q12 (RS422)

RD (G)
BU (M)
BK (H)
GN (C)
GY/PK (K)
WH (A)

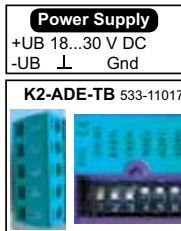

RS232



USB

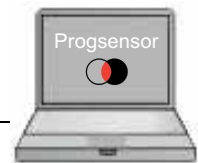

FT 50 C ... S1 (RS485) FT 50 RLA 220/70-S1L8 (RS485) FT 80 RLA 500-S1L8 (RS485)

BU (7)
GY (5)
WH (1)
PK
RD
YE
BN (2)
BK

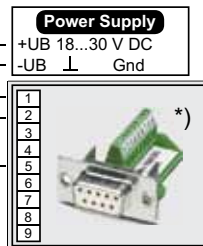

CUSB-RS485-SET
533-01005

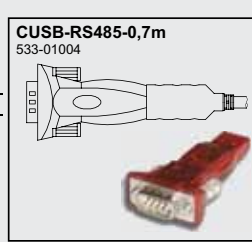

USB

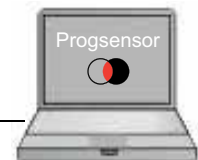

FR 85-2 ILLG-S1L5 (RS485)

BU (3)
GY
BK (4)
PK
RD
YE
BN (1)
WH (2)

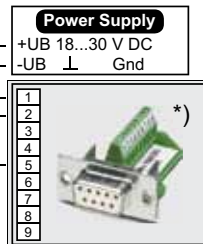

CUSB-RS485-SET
533-01005

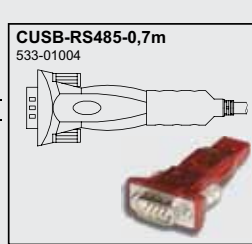

USB

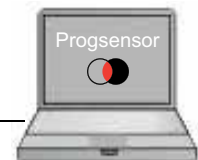

*) Über Phoenix Contact einzeln erhältlich als VS-09-BU DSUB/9-MPT-0,5
Individually available from Phoenix Contact as VS-09-BU DSUB/9-MPT-0,5
Séparément disponible chez Phoenix Contact nommé VS-09-BU DSUB/9-MPT-0,5

Download software: www.sensopart.com

Power supply units and switching devices

Power supply units and switching devices		
	<p>Part number / Article number</p> <p>Description</p>	<p>ST-05 / 997-51467</p> <p>Sensor tester for PNP and NPN sensors</p> <ul style="list-style-type: none"> – battery operated, 2 x 9 Volt (supplied) – with acoustic and optical signalling of switching output
	<p>Part number / Article number</p> <p>Description</p>	<p>PA L4M4-TI / 997-51465</p> <p>Teach-in unit for programming of SmartPlugs and sensors with Teach input</p> <ul style="list-style-type: none"> – power supply voltage connection via 3-wire cable – M8 and M12 connection plugs
	<p>Part number / Article number</p> <p>Description</p>	<p>Setup Box FR 85-2 ILLX / 533-11016</p> <p>Setup Box for FR 85 Rail Pilot system. Enables parameterisation of the switching points of FR 85 via PC</p> <ul style="list-style-type: none"> – Connection of power supply via plug M12, 5-pin – M12, 8-pin – Plug adapter M12, 8-pin to M12, 5-pin for the connection of FR 85 (5-pin) – RS232 interface for connection to PC – Gender Changer – Null modem adapter
	<p>Part number / Article number</p> <p>Description</p>	<p>ST M12-12 / 994-51135</p> <p>Power supply unit for V10 / V20, M12 connector; 12-pin, Europlug</p> <ul style="list-style-type: none"> – connection of power supply voltage via Europlug – M12 connector
	<p>Part number / Article number</p> <p>Description</p>	<p>ST M12-12-M / 994-51138</p> <p>Power supply unit for V10 / V20, M12 connector; 12-pin, Multiplug</p> <ul style="list-style-type: none"> – connection of power supply voltage via Multiplug – M12 connector
	<p>Part number / Article number</p> <p>Description</p>	<p>ST V10 / 543-11022</p> <p>Demo and Test Box for all V10 / V20 types. Allows test mode with simulation of inputs (triggers, etc.) and the display of outputs. All I/Os are through-wired, so parallel operation with controller also possible.</p> <p>Connections:</p> <ul style="list-style-type: none"> – V10 / V20 via 12-pin, plug-in screw terminal – Trigger sensor via 9-pin, plug-in screw terminal and encoder input – PLC via M12 plug, 12-pin – Power supply via 9-pin, plug-in terminal – Power supply via small device plug – Display of switching outputs via LEDs – Operation of inputs via buttons; NPN / PNP selectable

SG 12

Power supply unit and switching device for standard rails



PRODUCT HIGHLIGHTS

- DIN rail mounting
- Switch on/off delay
- Inversion of output

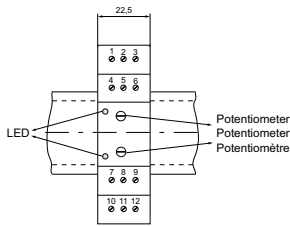
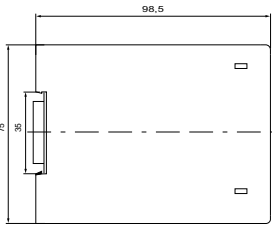
Functions		Dimensional drawing	
LED indicator, yellow Adjustment possibilities	Switching state indicator Delay: rise / fall: 50 ms ... 30 s Input impulse: ≥ 50 ms		
		090-12339	
Electrical data		Mechanical data	
Operating voltage, $+U_B$ (L1 - N)	See Selection Table	Dimensions	$98,5 \times 75 \times 22,5$ mm ³
No-load current, I_0	16 mA at 230V AC / 32 mA at 115V AC	Enclosure rating	IP 40 ²
Switching output	Relay contact	Material, housing	Makrolon
Switching function	Change-over contact, potential-free	Type of connection	See Selection Table
Switching current	Max. 8 A	Ambient temperature: operation	-30 ... +70 °C
Switching voltage	380V AC / 250V DC	Weight	250 g
Switching frequency (ti/tp 1:1)	≤ 10 Hz		
Duty cycle	1		
Output current, sensor	45 mA		
Power supply (V), sensor	$24V \pm 10\%$ DC ¹		
Device input	PNP / NPN		
Repeatability	$\leq 5\%$		

¹ 2 % output ripple ² With connected IP 40 plug

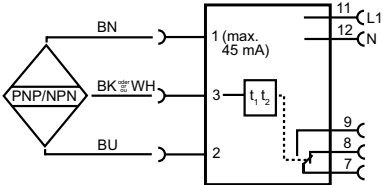
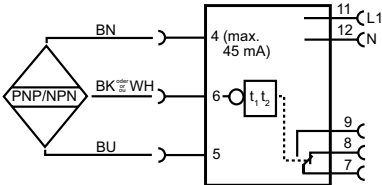
Connection, non-inverted operation	Connection, inverted operation
	
154-00161	154-00162

Operating voltage	Type of connection	Part number	Article number
230V AC (40 ... 60 Hz)	Terminals	SG 12 T-00	688-51089
115V AC (40 ... 60 Hz)	Terminals	SG 12 T-02	688-51090



PRODUCT HIGHLIGHTS

- Input/output expansion for V10, V20
- Transcribes sensor's serial data to discrete outputs
- 32 digital switching outputs for the discrete provision of up to 32 individual digital results
- 8 digital switching inputs, e.g. for changing over configurations
- Encoder input, e.g. for ejector control independent of conveyor speed
- Rail mounting
- Display for easy visualisation and operator guidance

Functions		Dimensional drawing, IO Box	
Programmable time function	Switch-on delay 0 to 7 s, switch-off delay 0 to 1 s, each adjustable in 1 ms increments via control panel.		
Programmable counting function	Alternative to time function, 0 to 2000 encoder steps for switch-on delay, 0 to 200 encoder steps for switch-off delay (acc. to prescaler), each adjustable in individual steps via control panel, cache for 512 parts.		
Ejector	2x potential-free relay contacts N.O. / N.C. (2 A / 24 V)		
Electrical data		Mechanical data	
Operating voltage +U _B	20.4 ... 26.4V DC	Dimensions	107.6 × 104.2 × 60.7 mm
No-load current, I ₀	≤ 250 mA	Enclosure rating	IP 20
Switching outputs	32x PNP (50 mA per output), total current max. 1 A	Material, housing	Plastic
On delay, t _{On} , switching output	≤ 2 ms	Connection system	Screw clamp contacts, plug-in
Off delay, t _{Off} , switching output	≤ 2 ms	Ambient temperature: operation	5 ... +50 °C
Inputs	8 x	Ambient temperature: storage	0 ... +50 °C
U _{IN,HIGH} control/trigger inputs	> 18V	Vibration and impact resistance	EN 60947-5-2
U _{IN,LOW} control/trigger inputs	< 3V		
Max. permissible cable length	Power 3 m, others 30 m		

Part number	Article number
T-AS7T-12ET34PRD	533-01008

Accessories	
Connection cable (data cable)	From Page A-34

PV-AW710.4TX

Display and configuration device for SensoPart vision sensors



PRODUCT HIGHLIGHTS

- Display and configuration device for SensoPart vision sensors and systems
- Suitable for installation in switching cabinet doors and operating panels
- Completely preconfigured

Functions		Dimensional drawing	
Display of results	10.4" screen diagonal		
Configuration of VISOR and Eyesight	Touch-sensitive screen panel		
Ready to use	Operating system Windows 7 and current SensoPart software pre-installed		
		<p>153-01188</p>	
Electrical data		Mechanical data	
Operating voltage, +U _B	12V DC, power supply unit 230V included, alternatively supply via screw-fastened DC input	Dimensions	25.5 x 20.2 x 5 cm
CPU	Intel Atom N270	Installation dimensions	24.2 x 19.2 x 3.15
Interfaces	4x USB 2.0, 2x RJ-45, 2x Com-Port (RS232)	Enclosure rating	IP 20
Memory	min. 4GB RAM, 60 GB SSD	Ambient temperature: operation	0 ... +50°C
		Ambient temperature: storage	0 ... +60°C
		Attachment	VESA-100 bracket for mounting
		Weight	2000 g

Part number	Article number	Description
PV-AW710.4TX_EN	533-01018	PanelViewer 10.4" (EN), Atom, Win7, Touch, XGA
MP PPC 10.4	533-01013	Mounting kit PanelViewer 10.4"

Accessories	
Connection cable (Ethernet cable)	From Page A-34

